

Control Modes

- Gearing, Position, Velocity, Torque

Command Interface

- Stepper commands
- $\pm 10V$ velocity/torque command
- PWM velocity/torque command
- Master encoder [Gearing]

Communications

- RS232

Feedback

- Digital Quad A/B encoder
- Digital Halls

I/O - Digital

- 6 inputs, 2 outputs

Dimensions: mm [in]

- 168 x 99 x 31 [6.6 x 3.9 x 1.2]



MODEL	IC	IP	VDC
ASP-055-18	6	18	55
ASP-090-09	3	9	90
ASP-090-18	6	18	90
ASP-090-36	12	36	90
ASP-180-09	3	9	180
ASP-180-18	6	18	180

DESCRIPTION

Accelus is a 100% digital servoamplifier in a panel-mount package with a family of power options to 12A continuous and 36A peak. This new series offers sinusoidal commutation of brushless motors in torque, velocity, or position modes and fast, easy set up with CME 2™ software.

CME 2™ software communicates with Accelus through an RS-232 link for complete amplifier setup. Auto-phasing and auto-tuning algorithms in CME 2™ slash set up times for fast system commissioning and eliminate “re-wire and try” so common in brushless motor installations. CME 2™ automates current loop tuning, as well as motor, Hall, and encoder phasing. A powerful oscilloscope and signal generator display amplifier performance for fine tuning thereafter. Amplifier control parameters are saved in non-volatile flash memory. OEM’s can inventory one part, and configure amplifiers on-site to each axis in a machine.

Advanced field-oriented-control ensures the highest motor torque over a wide speed range, minimizing motor heating and maximizing efficiency. Digital control algorithms transform stator currents into direct and quadrature components. The torque-producing quadrature current is controlled by the current loop, and the direct component is driven to zero eliminating losses from current that doesn’t produce torque. Space-vector modulation produces higher speeds than sine-pwm modulation from the same power supply.

Accelus works with motion controllers that close position-loops using incremental encoder feedback and process the position error in a PID filter to produce an amplifier command for torque, force, or velocity. Only one $\pm 10V$ analog, or a one or two-wire digital PWM/DIR control signal is required. All commutation is done in the amplifier.

In position-mode, Accelus accepts two-wire digital step-motor control signals (CW/CCW, or Count/Direction), or operates as a slave from a master encoder. The ratio between input position pulses and motor position is programmable.

Velocity control is derived from motor encoder signals. Velocity mode is useful not only for speed-setpoint applications, but enables operation with PLC’s or controllers that output position-error signals with no PID filtering.

All amplifier circuits are DC coupled and operate from unregulated transformer-isolated DC power supplies, or regulated switching power supplies.

The panel-mount package is compatible with the mounting footprint of Copley’s 5xx1 series trapezoidal brushless amplifiers, offering an easy upgrade to sinusoidal commutation with digital control.

GENERAL SPECIFICATIONS

Test conditions: Load = 3-phase Wye connected load, 2 mH line-line. Ambient temperature = 25 °C. +HV = HVmax

MODEL	ASP-055-18	ASP-090-09	ASP-090-18	ASP-090-36	ASP-180-09	ASP-180-18	
-------	------------	------------	------------	------------	------------	------------	--

OUTPUT POWER							
Peak Current	18 (12.7)	9 (6.4)	18 (12.7)	36 (25.5)	9 (6.4)	18 (12.7)	Adc (Arms)
	Peak time	1	1	1	1	1	1
Continuous current	6 (4.2)	3 (2.1)	6 (4.2)	12 (8.5)	3 (2.1)	6 (4.2)	Adc (Arms) per phase
Peak Output Power	0.92	0.79	1.55	2.95	1.59	3.15	kW
Continuous Output Power	0.32	0.27	0.53	1.0	0.53	1.06	kW

INPUT POWER							
HV _{min} to HV _{max}	+20 to +55	+20 to +90	+20 to +90	+20 to +90	+20 to +180	+20 to +180	Vdc, Transformer-isolated
Peak current	20	10	20	40	10	20	Adc (1 sec) peak
Continuous current	6.7	3.3	6.7	13.3	3.3	6.7	Adc continuous

PWM OUTPUTS							
Type	3-phase MOSFET inverter, 20 kHz center-weighted PWM, space-vector modulation						
PWM ripple frequency	40 kHz						

COMMUTATION & CONTROL							
Current loop	20 kHz (50 µs period) update rate						
Velocity & position loop	4 kHz (250 µs period) update rate						
Commutation	Sinusoidal, field-oriented control of DC brushless motor						
Phase Initialization	Amplifier initializes in trapezoidal commutation until a Hall transition occurs, then switches to sinusoidal commutation with phase-correction at each Hall signal transition						

BANDWIDTH							
Current loop, small signal	3 kHz typical, bandwidth will vary with tuning & load inductance						
HV Compensation	Changes in HV do not affect bandwidth						

REFERENCE INPUTS (NOTE 1)							
Analog torque/velocity	±10Vdc, 12 bit resolution		Differential (J3-2,14)				
Input impedance	66 kΩ		Between Ref(+), Ref(-)				
Digital position reference	Pulse/Direction, CW/CCW		Stepper commands (2 MHz maximum rate)				
	Quad A/B Encoder		20 Mcount/sec (after quadrature), 5 Mline/sec				
Digital torque & velocity reference	PWM, Polarity		PWM = 0~100%, Polarity = 1/0				
	PWM		PWM = 50% +/-50%, no polarity signal required				
	PWM frequency range		1 kHz minimum, 100 kHz maximum				
	PWM minimum pulse width		220 ns				

DIGITAL INPUTS (NOTE 1)							
All inputs	74HC14 Schmitt trigger operating from 5.0 Vdc with RC filter on input						
Logic levels	Vin-LO < +1.35 Vdc, Vin-HI > +3.65 Vdc, Input voltage range 0 to +24 Vdc						
Pull-up, pull-down control	[IN2,3,4] have group selectable connection of 10 kΩ input pull-up/down resistor to +5 Vdc or ground						
Enable [IN2]	Dedicated input with 330us RC filter for amplifier enable, active level programmable						
GP [IN1,2,3,4]	General Purpose inputs with 330us RC filter and active level select, [IN1,3,4] have programmable functions						
HS [IN5,6]	High-Speed Inputs inputs with 100ns RC filter, active level select, and programmable functions						

SERIAL DATA INPUT							
RS-232	Rx/D, Tx/D, Gnd in 6-position, 4-contact RJ-11 type modular connector, and on J3-24, 25, & 13 Full-duplex, serial communication port for amplifier setup and control, 9600 to 115200 baud Data protocol: binary						

MOTOR CONNECTIONS							
Phase U, V, W	Amplifier outputs to 3-phase Wye or delta connected brushless motors with floating neutral						
Hall U, V, W	Digital Hall signals						
Encoder A, /A, B, /B, (X,/X)	Quadrature encoder signals, single-ended or differential (X or Index signal not required)						
	5 MHz maximum line frequency (20 Mcount/s) when driven from active differential outputs						
[IN1] Motemp	See Digital Inputs (above) for details (Note 1)						

STATUS INDICATORS							
Amp Status	Bicolor LED. Amplifier status indicated by color, and blinking or non-blinking condition						

DIGITAL OUTPUTS (NOTE 1)							
Type [OUT1,2]	Current-sinking MOSFET open-drain output with 1kΩ pullup to +5 V through diode, 1 Adc sink max, +30 Vdc max. Programmable External flyback diode required with inductive loads						

PROTECTIONS							
HV Overvoltage	+HV > HV _{max}		Amplifier outputs turn off until +HV < HV _{max} (See Input Power for HV _{max})				
HV Undervoltage	+HV < 20 th Vdc		Amplifier outputs turn off until +HV > 20 th Vdc				
Amplifier over temperature	PC Board > 70 °C.						
Short circuits	Output to output, output to ground, internal PWM bridge faults						
I ² T Current limiting	Programmable: continuous current, peak current, peak time						
Motor over temperature	Digital inputs programmed for overtemp function will disable amplifier						

MECHANICAL & ENVIRONMENTAL							
Size	6.58 in (167,1 mm) X 3.89 in (98,81 mm) X 1.17 in (29,72 mm)						
Weight	0.94 lb (0.43 kg) for amplifier without heatsink						
Ambient temperature	0 to +45 °C operating, -40 to +85 °C storage						
Humidity	0% to 95%, non-condensing						
Contaminants	Pollution degree 2						
Environment	IEC68-2: 1990						
Cooling	Heat sink and/or forced air cooling may be required for continuous power output (see pg. 8 & 9)						

Notes
1. Digital input & output functions are programmable. Default functions are shown here.

COMMUNICATION

Accelus is configured via a three-wire, full-duplex RS-232 port that operates from 9600 to 115,200 Baud. CME 2™ provides a graphic user interface (GUI) to set up all of Accelus features via a computer serial port. Connections to the Accelus RS-232 port P1 are via an RJ-11 style connector, and through the signal connector J3 (J3-24 & 25). Rx/D, Tx/D, and Gnd signals comprise the signals supported. The Accelus Serial Cable Kit contains a modular cable, and an adapter that connects to a 9-pin, Sub-D serial port connector (COM1, COM2, etc.) on PC's and compatibles.

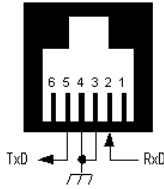

RS-232 Port

STATUS LED

A single bi-color LED gives the state of the amplifier by changing color, and either blinking or remaining solid. The possible color and blink combinations are:

- **Green/Solid:** Amplifier OK and enabled. Will run in response to reference input.
- **Green/Slow-Blinking:** Amplifier OK but not-enabled. Will run when enabled.
- **Green/Fast-Blinking:** Positive or Negative limit switch active. Amplifier will only move in direction not inhibited by limit switch.
- **Red/Solid:** Temporary fault condition. Amplifier will resume operation when fault is removed.
- **Red/Blinking:** Latching fault. Operation will not resume until amp is Reset

Fault conditions: Short-circuits from output to output, output to ground, and internal shorts or over current conditions, amplifier or motor over-temperature, over or under-voltage, encoder power loss, motor phasing error (current position > 60° electrical from Hall angle), or position-mode following error. Faults are programmable as latching or non-latching.

DIGITAL INPUTS

There are six digital inputs [IN1-6] five of which are programmable functions. Inputs [IN1, 5, & 6] have 10 kΩ pull-up resistors that connect to +5 Vdc to work with grounded switches, NPN open-collector, CMOS, or TTL outputs.

[IN2] always functions as the Enable input, and controls the ON/OFF state of the amplifier outputs. [IN2] can function simply as the amp-enable or as the amp-enable with reset. With the reset options selected, the amplifier will reset when [IN2] goes from the active to the inactive level. The default selection is active-LO with no reset. This setting is the fail-safe condition. In order to make the amplifier operate, the enable input must be connected and must be grounded to operate the amplifier. If a wire were to break, or the controller malfunction, the input would not be grounded and the amplifier would not operate. If the input is set to Active-HI, it is not in a fail-safe mode, and will be enabled with no connection to the [IN2] input. This setting is therefore not

recommended for general operation.

The other digital enable inputs, [IN1], [IN3-6] have alternate functions that are settable via CME 2™:

- Positive Limit Switch
- Negative Limit Switch
- Amplifier Reset
- Motor temp sensor

In addition to the alternate functions, the active level for each input is individually programmable.

Amplifier reset takes place on transitions of the input and is programmable to 1/0 or 0/1. The motor temp sensor function will disable the amplifier if a switch in the motor opens or closes when the motor overheats. The motor temperature switch or sensor should be grounded. The active-level setting is then set depending on the type of switch: normally open, or normally closed.

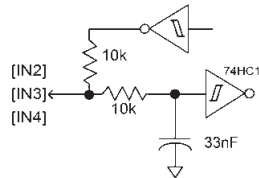
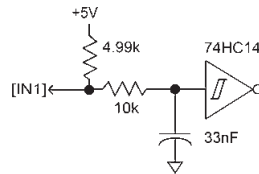

Input resistors are programmable to pull-up to +5 Vdc or pull-down to signal ground as a group for [IN2,3,4].

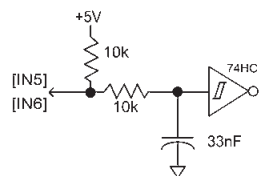

DIGITAL OUTPUTS

Digital outputs are open-drain MOSFETs with 1 kΩ pull-up resistors to +5 Vdc. These can sink up to 1 Adc from external loads operating from power supplies to +30 Vdc. When driving inductive loads such as a motor brake, an external fly-back diode is required. A diode in the output is for driving PLC inputs that are opto-isolated and connected to +24 Vdc. The diode prevents conduction from +24 Vdc through the 1 kΩ resistor to +5 Vdc in the amplifier. This could turn the input on, giving a false indication of the amplifier output state.

These outputs are level-selectable like the inputs, and each output is programmable for various functions.

Digital outputs

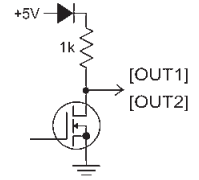

REFERENCE INPUTS

The Reference inputs command the amplifier to produce an output. Accelus has analog and digital reference inputs. Only one type can be active at a time.

ANALOG REFERENCE INPUT

The analog ±10 Vdc signal is an industry standard for torque or velocity control. The analog reference input is a differential amplifier which is to be connected to the motion controller ground and DAC output. Using a differential amplifier is important because there may be potential differences between the amplifier and controller grounds. The differential amplifier construction rejects these differences and measures the controller output relative to ground at the controller. Note that the voltage between Ref(+) and Ref(-) inputs must be zero to produce a "zero" amplifier command. Grounding Ref(-), and allowing Ref(+) to be open will produce a large command, as will grounding Ref(+) and letting Ref(-) be open.

When wiring the controller DAC output to the reference inputs, be sure to use both reference inputs, and connect Ref(-) to ground at the controller, and not at the amplifier.

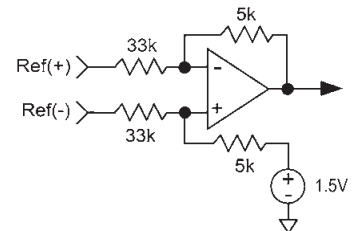

IMPORTANT!

ALWAYS CONNECT BOTH ANALOG REF INPUTS. THERE MUST BE ZERO VOLTS BETWEEN REF(+) & REF(-) FOR ZERO OUTPUT FROM THE AMPLIFIER!

DIGITAL REFERENCE INPUTS

There are two logic inputs [IN5] and [IN6] for digital reference signals that are programmable for controlling torque, velocity, or position. If not used as reference inputs, they are programmable as logic inputs. When used as reference inputs these should be driven by active-output devices (i.e. CMOS, TTL). The input resistors define the default polarities when inputs are open, or for use with open-collector devices as digital logic inputs.

DIGITAL REFERENCE INPUTS (CONT'D)

PWM Torque/velocity input or CW/Pulse/Encoder-A position input

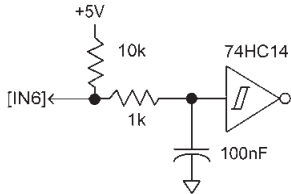

Torque/Velocity polarity or CCW/Direction/Encoder-B position input

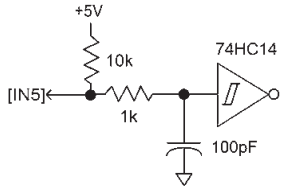

Duty-cycles of 0%, and 100% would result in negative full-scale, or positive full-scale outputs. So, the duty-cycle controls not only the magnitude, but also the polarity of the amplifier outputs.

The scale-factor for amplifier-output vs. PWM inputs is settable via CME 2™ software in both cases.

50% PWM signals for torque/velocity reference

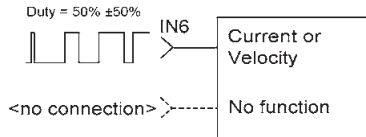

Master encoder signals as position reference inputs

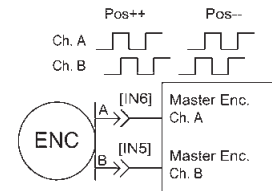

IMPORTANT!

AMPLIFIERS WITH SERIAL NUMBERS EQUAL TO OR LESS THAN THE NUMBERS SHOWN HERE HAVE THE INPUT CONFIGURATION SHOWN BELOW FOR [IN6]
 ASP-090-09, ASP-180-09: s/n 5102xxxx
 ASP-055-18, ASP-090-18, ASP-180-18: 3102xxxx
 ASP-090-36: 3502xxxx

NOTE: THE LAST FOUR DIGITS ARE NOT SIGNIFICANT

When operating Accelus in position mode, the digital reference inputs accept step-motor pulses in two formats, or quadrature-encoder signals. In either case, the ratio between input pulses, and motor encoder counts is programmable.

The first format of stepper-command signals is the CW/CCW (clockwise/counter-clockwise) format, which could also be called CU/CD (count-up/count-down). Pulses at [IN6] will increase the position-command to the amplifier, and pulses at [IN5] will decrease it. The other stepper-command format is the Pulse & Direction one where pulses at [IN6] will increment or decrement the position-command depending on the DC level at the Direction input, [IN5].

The active-edge is programmable for 0-1 or 1-0 transitions when in Pulse/Dir or CW/CCW input modes.

Digital reference inputs configured as CW/CCW inputs in position mode with 0-1 active-edges:

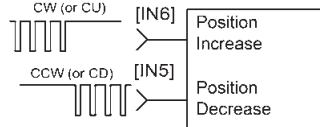

Digital reference inputs configured as Pulse-Direction inputs in position mode with 0-1 active-edges:

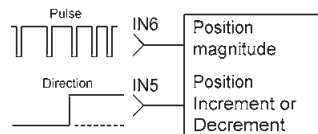

DIGITAL REFERENCE INPUTS

For torque or velocity control, the inputs may be configured in two formats:

1. PWM (0~100%) & Polarity
2. PWM (50%)

In the first case, the PWM signal can vary from 0% to 100%, and the Polarity signal is a DC level that controls the direction of the motor. The PWM duty-cycle controls the amplifier output current, or motor velocity. In current mode, 100% corresponds to the maximum output current. In velocity mode, it commands the maximum velocity that is configured.

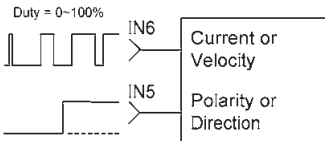

Another type of PWM input is the "50%" type. There is only one PWM signal that connects to [IN6]. The other digital input [IN5] is not used in this mode. A 50% duty-cycle corresponds to a zero-current command in torque mode, or a zero-speed output in velocity mode.

another amplifier and controller, it is referred to as "master-slave" operation. The master in this case is the motor controlled externally, and the Accelus™ is the slave, following the position of the master in a ratio that is configurable via CME 2™.

MOTOR CONNECTIONS

Motor connections are of three types: phase, Halls, and encoder. The phase connections carry the amplifier output currents that drive the motor to produce motion. The Hall signals are three digital signals that give absolute position feedback within an electrical commutation cycle. The encoder signals give incremental position feedback and are used for velocity and position modes, as well as sinusoidal commutation.

MOTOR ENCODER

The input circuit for the motor encoder signals is a differential line-receiver with R-C filtering on the inputs. The circuit is shown below. Encoders with differential outputs are preferred because they are less susceptible to noise that can be picked on single-ended outputs. For best results, encoder cabling should use twisted pair cable with one pair for each of the encoder outputs: A & /A, B & /B, and X & /X. Shielded twisted-pair is best for noise rejection. If single-ended encoders are used they should connect to J2-6,7,8. Encoders that require 200 mA or less can operate from amplifier +5 Vdc on J2-11. If more current is required then +5 Vdc from the user system can connect to J3-22 and will be available on J2-10. The encoder input circuit is shown below.

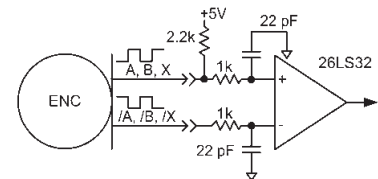

MOTOR HALL SIGNALS

Hall signals are single-ended signals that provide absolute feedback within one electrical cycle of the motor. There are three of them (U, V, & W) and they may be sourced by magnetic sensors in the motor, or by encoders that have Hall tracks. They typically operate at much lower frequencies than the motor encoder signals, and in Accelus they are used for commutation-initialization after power-on, and for checking the motor phasing after the amplifier has switched to sinusoidal commutation.

MOTOR HALL SIGNALS (CONT'D)

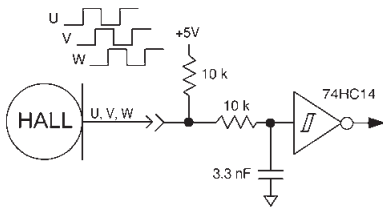

MOTOR PHASE CONNECTIONS

The amplifier output is a three-phase PWM inverter that converts the DC buss voltage (+HV) into three sinusoidal voltage waveforms that drive the motor phase-coils. The three phase currents I_u , I_v , and I_w sum to zero so individual conductors in the motor cable should be sized for the continuous current rating of the amplifier. Motor cabling should use twisted, shielded conductors for CE compliance, and to minimize PWM noise coupling into other circuits. The motor cable shield should connect to motor frame and the amplifier HV ground terminal (J1-2) for best results.

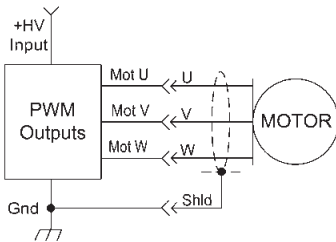

GROUNDING CONSIDERATIONS

All circuits in Accelus share a common circuit ground (Gnd on J1-4, and Signal Ground on J2-5,12, and J3-10,12,13,15,16). Input logic circuits are referenced to Signal Ground, as are analog Reference inputs, digital outputs, encoder and Hall signals. For this reason, amplifier Gnd terminals should connect to the users' common ground system so that signals between amplifier and controller are at the same common potential, and to minimize noise. The system ground should, in turn, connect to an earthing conductor at some point so that the whole system is referenced to "earth".

Because current flow through conductors produces voltage-drops across them, it is best to connect the amplifier HV return (Gnd) to system earth, or circuit-common through the shortest path, and to leave the power-supply floating. In this way, the power supply (-) terminal connects to ground at the amplifier Gnd terminals, but the voltage drops across the cables will not appear at the amplifier ground, but at the power supply negative terminal where they will have less effect.

Motor phase currents are balanced, but currents can flow between the PWM outputs, and the motor cable shield. To minimize the effects of these currents on nearby circuits, the cable shield should connect to Gnd (J1-2).

The amplifier case does not connect to any amplifier circuits. Connections to the case are provided on connectors J2-1, and J3-1. Cables to these connectors should be shielded for CE compliance, and the shields should connect to these terminals. When installed, the amplifier case should connect to the system chassis. This maximizes the shielding effect of the case, and provides a path to ground for noise currents that may occur in the cable shields.

Signals from controller to amplifier are referenced to +5Vdc, and other power supplies in user equipment. These power supplies should also connect to system ground and earth at some point so that they are at same potential as the amplifier circuits.

The final configuration should embody three current-carrying loops. First, the power supply currents flowing into and out of the amplifier at the +HV and Gnd pins on J1. Second the amplifier outputs driving currents into and out of the motor phases, and motor shield currents circulating between the U, V, and W outputs and Gnd. And, lastly, logic and signal currents connected to the amplifier control inputs and outputs.

For CE compliance and operator safety, the amplifier should be earthed by using external tooth lockwashers under the mounting screws. These will make contact with the aluminum chassis through the anodized finish to connect the chassis to the equipment frame ground.

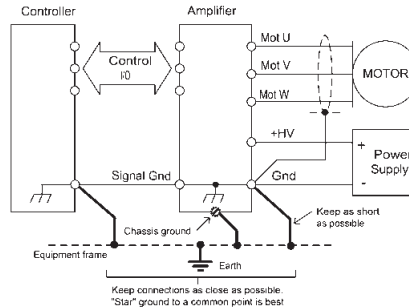

POWER SUPPLIES

Accelus operates typically from transformer-isolated, unregulated DC power supplies. These should be sized such that the maximum output voltage under high-line and no-load conditions does not exceed the amplifiers maximum voltage rating. Power supply rating depends on the power delivered to the load by the amplifier. In many cases, the continuous power output of the amplifier is considerably higher than the actual power required by an incremental motion application.

Operation from regulated switching power supplies is possible if a diode is placed between the power supply and amplifier to prevent regenerative energy from reaching the output of the supply. If this is done, there must be external capacitance between the diode and amplifier.

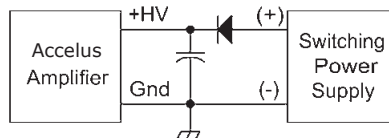

MOUNTING & COOLING

Accelus has slots for mounting to panels at 0° or 90°. Cooling is by conduction from amplifier heatplate to mounting surface, or by convection to ambient.

FUSING & PROTECTIONS

Fusing of input power connections to Accelus protects external circuits from an uncontrolled failure of the amplifier. Fusing of motor phase connections provides protection of the motor from overcurrents due to either mis-configuration of the amplifier, or uncontrolled failure of the amplifier. Motor phase fusing is recommended for linear motor applications as this type of motor has a lower thermal capacity, in general, than rotary motors due to the mounting of the phase coils in epoxy 'fins'. This factor, plus the higher cost factors associated with linear motor installations (mounting and accessibility, time to repair, initial cost) make the use of phase-fuses advisable as the ultimate protection for such motors. In many applications, Accelus will have peak and continuous ratings greater than the motors' ratings, so operator errors during setup or adjustments can easily damage the motor with little stress to the amplifier.

Depending on the application, fast-acting fuses may be the fuse of choice for motor phase protection. Typically, two fuses provide sufficient protection for motor currents as the phase currents sum to zero. If grounding of the motor winding is possible, then three fuses would provide complete protection for any overcurrents flowing out of the amplifier and into the motor.

Sizing of motor phase fuses should take into account the peak and rms current over the anticipated duty cycle of the motor, and motor ratings. The final value selected should be tested in the equipment to prove that no false tripping occurs under worst-case temperature and operating-current conditions.

The maximum input current to the amplifier should not exceed its rated output currents under normal operating conditions. Time-delay fuses typically carry 75% of their rating continuously, so choosing a fuse that can carry 33% more current than the continuous current rating of the amplifier should be prevent false tripping. The DC voltage rating should be sufficient to carry the amplifier +HV operating voltage.

AMPLIFIER CONNECTIONS

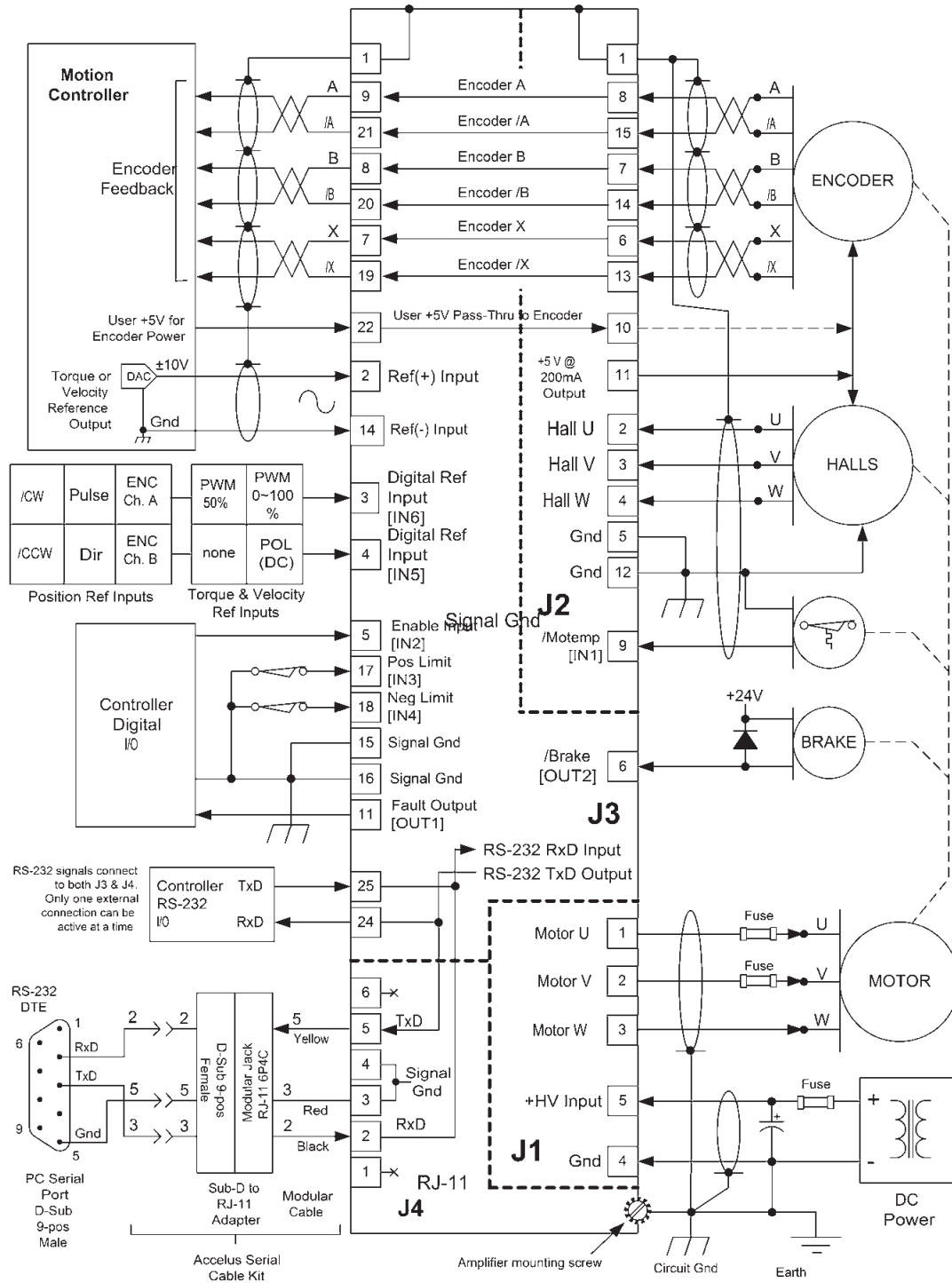

NOTES

1. The function of input signals on J2-9, and J3-3,4,17,18 and output signals on J3-6, 11 are programmable. Default functions are shown.
2. The function of [IN2] on J3-5 is always amplifier Enable and is not programmable.
3. The active level of [IN2,3, and 4] is programmable as a group to pull-up or pull-down.

AMPLIFIER CONNECTORS

- J1: +HV, Gnd, & Motor U,V,W Outputs
Molex/Beau 5,08mm, Eurostyle®, 5-position receptacle.
- J2: Motor Encoder & Halls
Sub-D, 15-position, female. #4-40 standoffs for cable connector shell screws.
- J3: Amplifier Signals
Sub-D, 25-position, female. #4-40 standoffs for cable connector shell screws.
- J4: Modular receptacle. RJ-11 style. 6-position, 4-contact.

MATING (CABLE) CONNECTORS

- P1: Molex/Beau 5,08mm, Eurostyle®, 5-position terminal block 860505-00, or equivalent.
 - P2: Sub-D, 15-position, male, #4-40 locking screws.
 - P3: Sub-D, 25-position, male, #4-40 locking screws.
 - P4: Modular plug. RJ-11 style. 6-position, 4-contact.
- Note: Connector Kit ASP-CK contains one each of P1, P2, and P3. P4 is part of the cable assembly in Serial Cable Kit SER-CK

J4 SIGNAL	PIN
No Connection	1
RxD Input	2
Ground	3
Ground	4
TxD Output	5
No Connection	6

J3 SIGNAL	PIN
Chassis Ground	1
Ref(+) Input	2
PWM Ref Input [IN6]	3
Direction Input [IN5]	4
Enable Input [IN2]	5
Motor Brake Output [OUT2]	6
Encoder X Output	7
Encoder B Output	8
Encoder A Output	9
Signal Ground	10
Fault Output [OUT1]	11
Signal Ground	12
Signal Ground	13

J2 SIGNAL	PIN
Chassis Ground	1
Hall U Input	2
Hall V Input	3
Hall W Input	4
Signal Ground	5
Encoder X Input	6
Encoder B Input	7
Encoder A Input	8

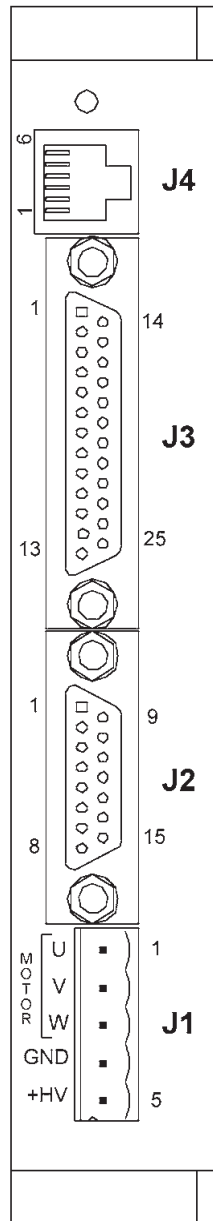

PIN	J3 SIGNAL
14	Ref(-) Input
15	Signal Ground
16	Signal Ground
17	[IN3] Forward Enable Input
18	[IN4] Reverse Enable Input
19	Encoder /X Output
20	Encoder /B Output
21	Encoder /A Output
22	User +5V Pass-Thru
23	+5V @ 200 mA
24	RS-232 TxD Output
25	RS-232 RxD Input

PIN	J2 SIGNAL
9	[IN1] Motor Temp Sensor
10	User +5V Pass-Thru
11	+5V @ 200 mA
12	Signal Ground
13	Encoder /X Input
14	Encoder /B Input
15	Encoder /A Input

PIN	J1 SIGNAL
1	Motor U Output
2	Motor V Output
3	Motor W Output
4	GND
5	+HV Input

NOTES

1. The function of signals on J2-9, and J3-3, 4, 6, 11, 17,18 are programmable. Default functions are shown.
2. The function of [IN2] on J2-5 is always Amplifier Enable and is not programmable. The active level of [IN2] is programmable, and amplifier Reset with enable is programmable.

POWER DISSIPATION

The charts on this page show the amplifier internal power dissipation for the *Accelus* models under differing power supply and output current conditions. Amplifier output current is calculated from the motion profile, motor, and load conditions. The values on the chart represent the rms (root-mean-square) current that the amplifier would provide during operation. The +HV values are for the average DC voltage of the amplifier power supply.

When +HV and amplifier output current are known, the amplifier power dissipation can be found from the chart. Once this is done use the data on the facing page to find amplifier thermal resistance. From this calculate the maximum ambient operating temperature. If this result is lower than the known maximum ambient temperature then a mounting with a lower thermal resistance must be used.

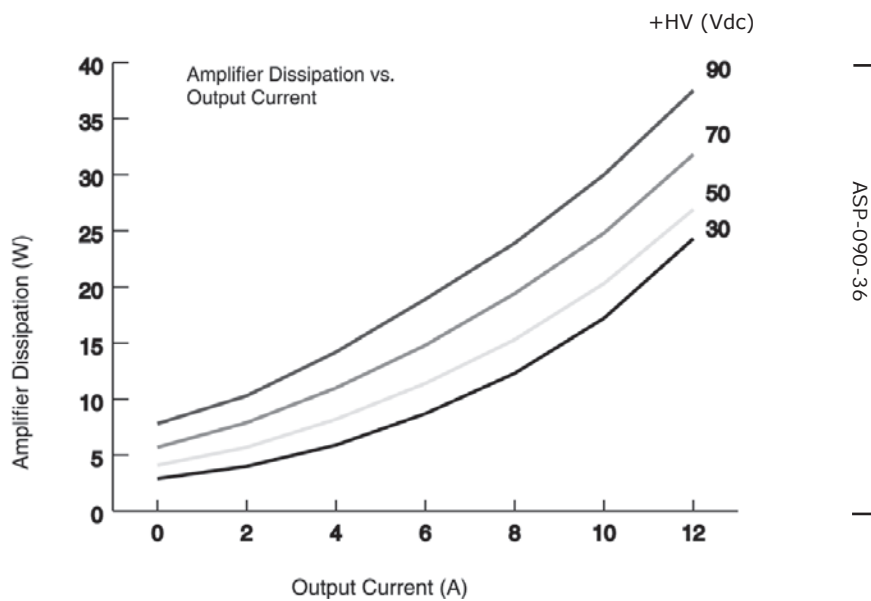
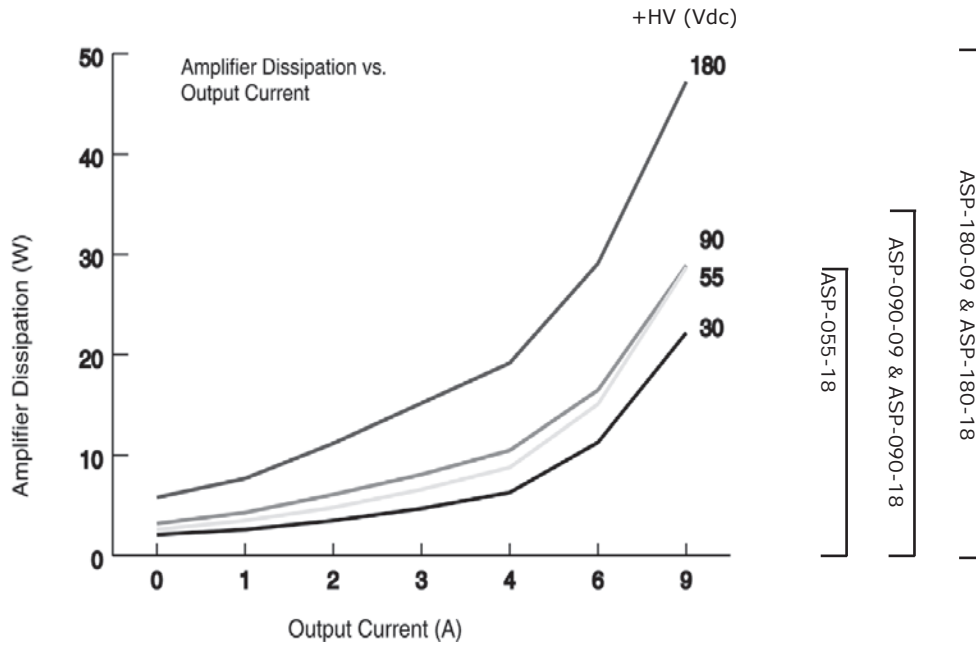

MOUNTING

Thermal data for convection-cooling with a heatsink assumes a vertical mounting of the amplifier on a thermally conducting surface. Heatsink fins run parallel to the long axis of the amplifier. When fan-cooling is used vertical mounting is not necessary to guarantee thermal performance of the heatsink.

THERMAL RESISTANCE

Thermal resistance is a measure of the temperature rise of the amplifier heatplate due to power dissipation in the amplifier. It is expressed in units of °C/W where the degrees are the temperature rise above ambient.

E.g., an amplifier dissipating 20 W mounted with no heatsink or fan would see a temperature rise of 28 °C above ambient based on the thermal resistance of 1.4 °C/W. Using the amplifier maximum heatplate temperature of 70 °C and subtracting 28 °C from that would give 42 °C as the maximum ambient temperature the amplifier in which the amplifier could operate before going into thermal shutdown.

TOP VIEW, VERTICAL MOUNTING

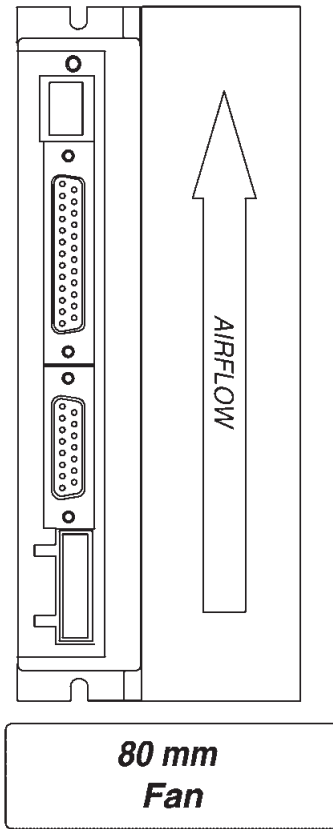

END VIEWS VERTICAL MOUNTING

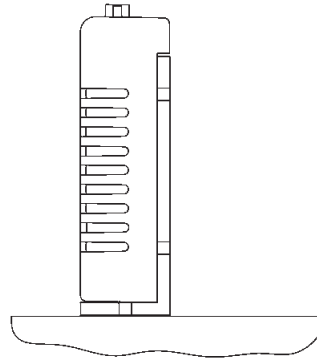

NO HEATSINK, NO FAN	°C/W
CONVECTION	2.9

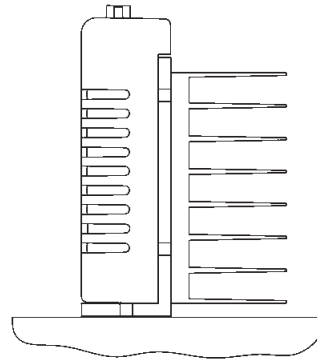

HEATSINK, NO FAN	°C/W
CONVECTION	1.7

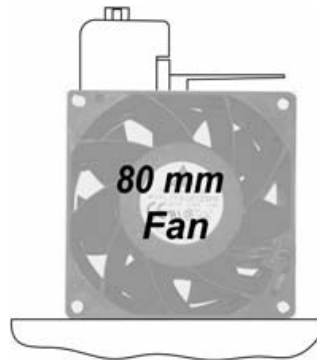

HEATSINK + FAN	°C/W
FORCED-AIR, 300 LFM	0.6

Note: Fans are customer-supplied

DIMENSIONS

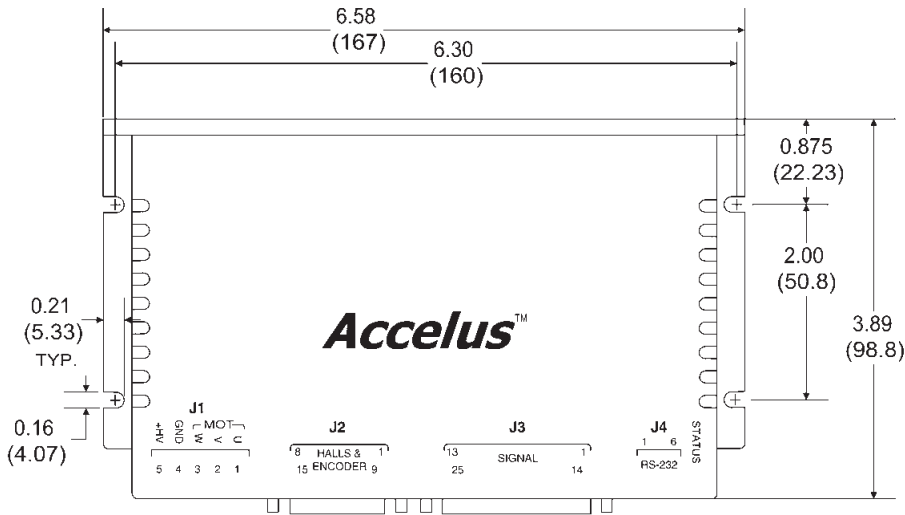

NOTES

1. Dimensions shown in inches (mm).

Note:

Use external tooth lockwashers between mounting screw head and amplifier chassis for safety and CE compliance.

Recommended screws are #6-32 (M3.5) torqued to 8~10 lb-in (0.79~1.02 N·m).

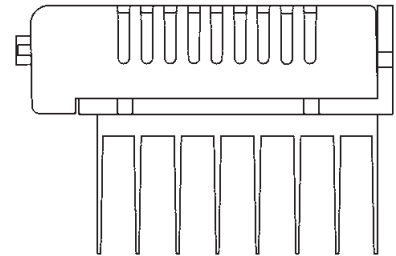
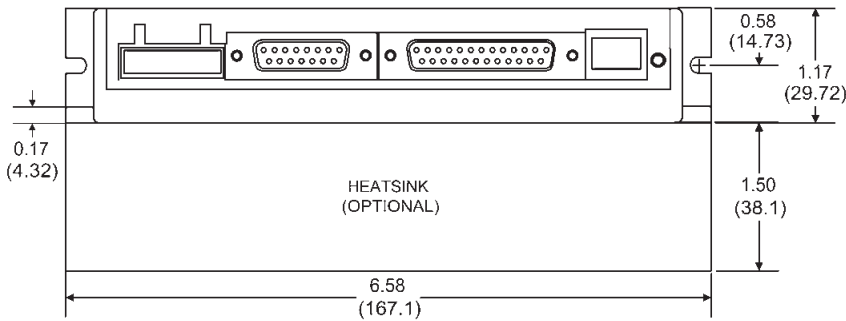

ORDERING GUIDE

PART NUMBER	DESCRIPTION
ASP-055-18	Accelus™ Servoamplifier 6/18A @ 55VDC
ASP-090-09	Accelus™ Servoamplifier 3/9A @ 90VDC
ASP-090-18	Accelus™ Servoamplifier 6/18A @ 90VDC
ASP-090-36	Accelus™ Servoamplifier 12/36A @ 90VDC
ASP-180-09	Accelus™ Servoamplifier 3/9A @ 180VDC
ASP-180-18	Accelus™ Servoamplifier 6/18A @ 180VDC
ASP-CK	Connector Kit for Accelus™ amplifier
SER-CK	Serial Cable Kit (1 per computer)
ASP-HK	Heatsink Kit (for customer installation)
CME2	CME 2™ CD (CME 2™, Manual)

ORDERING INSTRUCTIONS

Example: Order 1 ASP-090-18 amplifier with heatsink fitted at factory and associated components:

Qty	Item	Remarks
1	ASP-090-18-H	Accelus servoamplifier
1	ASP-CK	Connector Kit
1	SER-CK	Serial Cable Kit
1	CME2	CME 2™ CD

RoHS COMPLIANCE



Models with the green leaf symbol on the label are RoHS compliant.