

# CME User Guide



P/N 16-01157  
Revision 02  
April 2019

# Contents

<b>1</b>	<b>About This Manual</b> .....	<b>7</b>
1.1	Related Documentation .....	7
1.2	Copyrights .....	7
1.3	Document Validity .....	7
1.4	Product Warnings .....	7
1.5	Revision History .....	8
<b>2</b>	<b>Introduction</b> .....	<b>9</b>
2.1	Host Computer Requirements .....	9
2.1.1	Computer and Operating System .....	9
2.1.2	Default File Locations .....	9
2.1.3	Serial Communications .....	9
2.1.4	CAN Communications (With Copley CANopen Drives) .....	9
2.1.5	EtherCAT Communications (With Copley EtherCAT Drives) .....	9
2.2	Overview .....	9
2.2.1	Setup and Tuning .....	9
2.2.2	Indexing .....	9
2.2.3	Cam Tables .....	9
2.3	Servo Operating Modes and Control Loops .....	10
2.3.1	Control Loops Model .....	10
2.3.2	Basic Attributes of All Servo Control Loops .....	10
<b>3</b>	<b>Installation, Startup, and Interface Tour</b> .....	<b>11</b>
3.1	Download and Install CME Software .....	11
3.2	Special Notes for Windows 7, Windows 8 and Windows 10 .....	11
3.2.1	Installer .....	11
3.2.2	Set up CME to run as administrator .....	11
3.3	Start CME .....	13
3.4	Communications Wizard .....	13
3.4.1	Configure Serial Ports .....	13
3.4.2	Configure CANopen Network .....	15
3.4.3	Configure EtherCAT Network .....	17
3.5	Connect to an Amplifier .....	17
3.6	Rename an Amplifier .....	19
3.7	CME Interface Tour .....	20
3.7.1	Main Menu .....	20
3.7.2	Tool Bar .....	24
3.7.3	Functional Diagram .....	25
3.7.4	CAN Information and Status Bar .....	26
<b>4</b>	<b>Amplifier Setup</b> .....	<b>27</b>
4.1	Setup Procedure .....	27
4.1.1	Warnings and Notes .....	27
<b>5</b>	<b>Setup</b> .....	<b>30</b>
5.1	Overview .....	30
5.2	Change Setup Settings .....	31
<b>6</b>	<b>Motor Data</b> .....	<b>40</b>
6.1	Motor Data Screen Overview .....	40
6.2	Rotary Motor Parameters .....	41
6.3	Linear Motor Parameters .....	42
6.4	Feedback Notes .....	43
6.4.1	Encoder and Resolver Support .....	43
6.4.2	Dual Feedback .....	43
6.5	Calculate .....	44
6.6	Use Specification Data .....	45
6.7	Use Motor Plate Data .....	46
6.7.1	Characterize and Tune .....	47
<b>7</b>	<b>Digital Inputs and Outputs</b> .....	<b>52</b>
7.1	Digital Inputs .....	52
7.1.1	Digital Input Functions .....	53
7.2	Digital Outputs .....	55
7.2.1	Digital Output Functions .....	55
7.2.2	ID Switch and Network LED SLI .....	56
7.3	Custom Event Triggered Output .....	56
7.3.1	Latched vs. Non-Latched Custom Event .....	58
7.4	Custom Trajectory Status Triggered Output .....	59
7.5	Custom Position Triggered Output .....	60
	Output Regen settings .....	61

7.6	.....	61
7.7	Synchronizing PWM Switching Frequency .....	61
7.8	Analog I/O .....	61
7.8.1	Analog Motor Temperature Sensor .....	62
7.8.2	Analog Output .....	62
<b>8</b>	<b>Command Inputs .....</b>	<b>64</b>
8.1	Analog Command Settings .....	64
8.1.1	Analog Command Notes .....	65
8.1.2	Scaling .....	65
8.1.3	Dead Band .....	65
8.1.4	Offset .....	65
8.1.5	Monitoring the Analog Command Voltage .....	66
8.1.6	Analog Command in Position Mode .....	66
8.2	PWM Input Settings .....	66
8.2.1	50% Duty Cycle (One-Wire) .....	67
8.2.2	100% Duty Cycle (Two-Wire) .....	67
8.2.3	Failsafe Protection from 0 or 100% Duty Cycle Commands .....	67
8.3	Digital Position Input Settings .....	68
8.3.1	Pulse Smoothing .....	68
8.3.2	Pulse and Direction .....	69
8.3.3	Count Up/Count Down .....	69
8.3.4	Quadrature .....	69
8.4	Software Programmed Input Settings .....	70
8.4.1	Programmed Position .....	70
8.4.2	Programmed Velocity .....	70
8.4.3	Programmed Current .....	71
<b>9</b>	<b>Network Configuration .....</b>	<b>72</b>
9.1	CANopen Network .....	72
9.2	MACRO Network .....	73
9.3	EtherCAT Network .....	74
<b>10</b>	<b>Faults .....</b>	<b>75</b>
10.1	Overview .....	75
10.1.1	Latched vs Non-latched Faults .....	75
10.1.2	Example .....	75
10.2	Fault Descriptions .....	76
<b>11</b>	<b>Motor Phasing .....</b>	<b>78</b>
11.1	Auto Phase .....	78
11.1.1	Auto Phase Example: Servo Amplifier .....	78
11.1.2	Auto Phase Example: Stepper Amplifier, No Encoder .....	82
11.1.3	Auto Phase Example: Stepper Amplifier with Encoder, in Stepper Mode .....	82
11.1.4	Auto Phase Example: Stepper Amplifier with Encoder, in Servo Mode .....	83
11.2	Tips for Auto Phase Current and Increment Rate .....	86
11.3	Troubleshooting the Auto Phase Problems .....	86
11.3.1	Motor direction setup .....	86
11.3.2	Motor wiring setup .....	87
11.3.3	Phase count test .....	87
11.3.4	Halls wiring setup .....	87
11.4	Manual Phase .....	87
11.4.1	Phase Initialization for Motor without Halls (Algorithmic Phase Initialization Mode) .....	89
11.4.2	Manual Phase Example: Motor with Resolver .....	90
11.5	Troubleshoot Manual Phase w/ Encoder and Halls .....	92
11.5.1	Data accuracy test .....	92
11.5.2	Encoder wiring test .....	92
11.5.3	Hall signals test .....	92
11.5.4	Hall transition test .....	92
<b>12</b>	<b>Control Loops .....</b>	<b>93</b>
12.1	Current Loop Setup and Tuning .....	93
12.1.1	Current Loop Manual Tune .....	94
12.1.2	Current Loop Auto Tune .....	95
12.1.3	Notes on the Current Mode and Current Loop .....	98
12.1.4	Offset .....	98
12.1.5	Limits .....	98
12.1.6	Current Loop Gains .....	99
12.1.7	Current Loop Output .....	99
12.2	Velocity Loop Setup and Tuning .....	99
12.3	Notes on the Velocity Mode and Velocity Loop .....	102
12.3.1	Velocity Loop Diagram .....	102
12.3.2	Inputs .....	102

12.3.3	Velocity Loop Limits .....	102
12.3.4	Diagram: Effects of Limits on Velocity Command .....	103
12.3.5	Velocity Loop Gains .....	103
12.3.6	Velocity Gains Shift .....	104
12.3.7	Velocity Loop Filters .....	104
12.3.8	Velocity Loop Outputs.....	104
12.3.9	Proper Tracking Over Time.....	104
12.3.10	Velocity Tracking Illustration.....	104
12.4	Position Loop Setup and Tuning.....	105
12.4.1	Parameter.....	107
12.4.2	Description.....	107
12.4.1	Test S-Curve Profile .....	110
12.5	Notes on the Position Mode and Position Loop .....	112
12.5.1	Position Loop Diagram.....	112
12.5.2	Trajectory Limits.....	112
12.5.3	Position Loop Inputs From the Trajectory Generator.....	112
12.5.4	Position Loop Gains .....	113
12.5.5	Position Loop Feedback.....	113
12.5.6	Position Loop Output .....	113
12.5.7	Position Wrap .....	113
12.5.8	Following Error Faults .....	113
12.5.9	Following Error Warnings .....	113
12.5.10	Position and Velocity Tracking Windows .....	114
12.5.11	Following Error Fault Details .....	114
12.6	Motor Characterization .....	115
<b>13</b>	<b>Stepper Tuning .....</b>	<b>116</b>
13.1	Stepper Motor Support.....	116
13.2	Position Limits (Stepper Amplifier).....	116
	Parameter.....	117
	Description .....	117
13.3	Encoder Correction .....	117
	Test Encoder Correction.....	118
13.4	Detent Compensation Gain .....	118
<b>14</b>	<b>Homing.....</b>	<b>120</b>
14.1	Overview .....	120
14.2	Absolute Encoder Calibration.....	121
14.2.1	Mechanical Homing .....	121
14.2.2	Calibration .....	122
<b>15</b>	<b>Control Panel.....</b>	<b>123</b>
15.1	Control Panel Overview .....	123
15.2	Status Indicators and Messages.....	123
15.3	Control Panel Monitor.....	124
	Monitor Variables.....	124
15.4	Control Functions.....	124
15.5	Jog Mode.....	125
<b>16</b>	<b>Scope.....</b>	<b>127</b>
16.1	Overview .....	127
16.2	Menu, Display and Controls.....	127
16.2.1	File Menu .....	127
16.2.2	Display .....	128
16.2.3	Trace Display Zoom .....	129
16.2.4	Controls.....	129
16.3	Function Generator .....	130
16.4	Profile Generator .....	131
16.5	Trace Channel Variables .....	131
16.6	Trigger Setup.....	133
16.7	Measurement Tab.....	134
16.8	Control Loop Parameters .....	135
16.8.1	Gains Tab .....	135
16.8.2	Trajectory Limits Tab.....	136
16.8.3	Position Loop Parameters.....	136
16.8.4	Velocity Loop Parameters.....	136
16.8.5	Current Loop Manual Tune .....	<b>Error! Bookmark not defined.</b>
16.8.6	Current Loop Auto Tune.....	<b>Error! Bookmark not defined.</b>
16.8.7	Notes on the Current Mode and Current Loop .....	<b>Error! Bookmark not defined.</b>
16.8.8	Offset.....	<b>Error! Bookmark not defined.</b>
16.8.9	Limits.....	<b>Error! Bookmark not defined.</b>
16.8.10	Current Loop Gains.....	<b>Error! Bookmark not defined.</b>

16.8.11	Current Loop Output.....	<b>Error! Bookmark not defined.</b>
16.9	Velocity Loop Setup and Tuning.....	<b>Error! Bookmark not defined.</b>
16.10	Notes on the Velocity Mode and Velocity Loop .....	<b>Error! Bookmark not defined.</b>
16.10.1	Velocity Loop Diagram .....	<b>Error! Bookmark not defined.</b>
16.10.2	Inputs.....	<b>Error! Bookmark not defined.</b>
16.10.3	Velocity Loop Limits .....	<b>Error! Bookmark not defined.</b>
16.10.4	Diagram: Effects of Limits on Velocity Command.....	<b>Error! Bookmark not defined.</b>
16.10.5	Velocity Loop Gains .....	<b>Error! Bookmark not defined.</b>
16.10.6	Velocity Gains Shift .....	<b>Error! Bookmark not defined.</b>
16.10.7	Velocity Loop Filters .....	<b>Error! Bookmark not defined.</b>
16.10.8	Velocity Loop Outputs.....	<b>Error! Bookmark not defined.</b>
16.10.9	Proper Tracking Over Time .....	<b>Error! Bookmark not defined.</b>
16.10.10	Velocity Tracking Illustration.....	<b>Error! Bookmark not defined.</b>
16.11	Position Loop Setup and Tuning.....	<b>Error! Bookmark not defined.</b>
16.11.1	Parameter.....	<b>Error! Bookmark not defined.</b>
16.11.2	Description.....	<b>Error! Bookmark not defined.</b>
16.12	Scope Trace Files.....	154
16.13	Trace Viewer.....	154
<b>17</b>	<b>Filters .....</b>	<b>156</b>
17.1	Filter Settings .....	156
17.2	Filter Configuration Windows.....	156
17.3	Setting Parameters.....	156
17.4	Input Shaping .....	157
17.4.1	Analog.....	157
17.4.2	Velocity Loop.....	158
17.4.3	Current Loop .....	159
17.5	Standard Filter Types .....	159
17.5.1	Low Pass Filter .....	159
17.5.2	High Pass Filter.....	159
17.5.3	Notch Filter .....	160
17.5.4	Band Pass Filter .....	160
17.5.5	Custom Biquad Filter .....	160
17.6	Standard Filter Families.....	160
17.6.1	Butterworth Filter.....	160
17.6.2	Chebyshev Filter .....	161
17.6.3	Elliptic Filter .....	161
17.7	Input Shaping Window .....	161
	Input Shaping Types .....	162
17.8	Measuring Mechanical Vibration.....	162
17.8.1	Using an Accelerometer with CME .....	162
17.8.2	Using CME to Monitor Following Error .....	163
<b>18</b>	<b>Frequency Analysis.....</b>	<b>164</b>
18.1	Overview .....	164
18.2	User Interface .....	165
18.2.1	Graph.....	165
18.2.2	Graph Options Menu.....	165
18.2.3	Sine Sweep Controls .....	166
18.2.4	Log Text Window .....	170
18.2.5	Measurement .....	171
18.2.6	Plot Settings.....	173
18.2.7	File Menu .....	173
	File Menu Items.....	173
	Description .....	173
18.2.8	Filter Screen.....	173
18.2.9	Status Bar.....	173
<b>19</b>	<b>Data, Firmware, and Logs.....</b>	<b>175</b>
19.1	Amplifier RAM and Flash Memory.....	175
19.1.1	Amplifier RAM.....	175
19.1.2	Flash .....	175
19.2	Data Management Tools .....	175
19.2.1	Amplifier.....	175
19.2.2	Motor/Feedback Screen .....	176
19.3	Multi-Axis Data Tools .....	176
19.3.1	Copy Axis .....	176
19.3.2	Save/Restore Single Axis .....	177
19.4	Drive Configuration.....	178
19.4.1	Save Drive Configuration .....	178
19.4.2	Restore Drive Configuration .....	178

# CME User Guide

19.5	Copy Drive Data .....	178
19.6	Save MACRO File for Delta Tau Controllers.....	181
19.7	Lock/Unlock CME .....	181
19.8	Firmware Download .....	182
19.9	Error Log .....	184
19.10	Amplifier Properties .....	185
19.11	Communications Log .....	185
<b>20</b>	<b>Virtual Amplifier .....</b>	<b>187</b>
20.1	Overview .....	187
<b>21</b>	<b>Gain Scheduling .....</b>	<b>188</b>
21.1	Overview .....	188
21.2	Configure Gain Scheduling .....	188
21.3	Set Up Gain Scheduling Tables .....	189
<b>22</b>	<b>Regen Resistor Configuration .....</b>	<b>192</b>
22.1	Configure a Standard Copley Controls Regen Resistor .....	192
22.2	Configure a Custom Regen Resistor .....	193
<b>Appendix A .....</b>		<b>195</b>
<b>I<sup>2</sup>T Time Limit Algorithm .....</b>		<b>195</b>
	Overview .....	195
	Formulas and Algorithm Operation .....	195
<b>Appendix B .....</b>		<b>198</b>
<b>Homing Methods.....</b>		<b>198</b>
	Overview .....	198
	Homing Diagram Legend .....	198
	Homing Method Descriptions .....	198
	Set current position as home.....	198
	Next Index.....	198
	Limit Switch .....	199
	Limit Switch Out to Index .....	200
	Hardstop.....	200
	Hardstop Out to Index.....	201
	Home Switch.....	201
	Home Switch Out to Index .....	202
	Home Switch In to Index .....	203
	Lower Home.....	203
	Upper Home.....	204
	Lower Home Outside Index .....	205
	Lower Home Inside Index .....	206
	Upper Home Outside Index .....	207
	Upper Home Inside Index .....	208
<b>Appendix C .....</b>		<b>210</b>
<b>ASCII Commands/Serial Control .....</b>		<b>210</b>
	Copley ASCII Interface .....	210
	CME ASCII Command Line Interface Tool.....	210
	Single-Axis Serial Connection .....	211
	Multi-Drop Serial Connection .....	211
<b>Appendix D.....</b>		<b>212</b>
<b>Copley USB to RJ11 .....</b>		<b>212</b>
	Recommended Device .....	212
	Factory Settings .....	212
<b>Appendix E .....</b>		<b>215</b>
	Faults, Warnings & Status.....	215

# 1 ABOUT THIS MANUAL

## 1.1 Related Documentation

- Indexer 2 Program User Guide
- ASCII Interface Programmer's Guide
- Camming User Guide
- Parameter Dictionary
- Serial Encoder Guide

Copley Controls software and related information can be found at:  
[www.copleycontrols.com](http://www.copleycontrols.com).

## 1.2 Copyrights

No part of this document may be reproduced in any form or by any means, electronic or mechanical, including photocopying, without express written permission of Copley Controls.

CME, Copley Virtual Machine, CVM, Xenus, Accelnet, Stepnet, Accelus, and Junus are registered trademarks of Copley Controls.

Windows 7, Windows 8, and Windows 10 are registered trademarks of the Microsoft Corporation.

## 1.3 Document Validity

We reserve the right to modify our products. The information in this document is subject to change without notice and does not represent a commitment by Copley Controls. Copley Controls assumes no responsibility for any errors that may appear in this document.

## 1.4 Product Warnings

Observe all relevant state, regional and local safety regulations when installing and using Copley Controls amplifiers. For safety and to assure compliance with documented system data, only Copley Controls should perform repairs to amplifiers.



**DANGER**

### **Hazardous voltages.**

Exercise caution when installing and adjusting Copley amplifiers.

### **Risk of electric shock.**

On some Copley Controls amplifiers, high-voltage circuits are connected to mains power. Refer to hardware documentation.

### **Risk of unexpected motion with non-latched faults.**

After the cause of a non-latched fault is corrected, the amplifier re-enables the PWM output stage without operator intervention. In this case, motion may re-start unexpectedly. Configure faults as latched unless a specific situation calls for non-latched behavior. When using non-latched faults, be sure to safeguard against unexpected motion.

**Latching an output does not eliminate the risk of unexpected motion with non-latched faults.**

Associating a fault with a latched, custom-configured output does not latch the fault itself. After the cause of a non-latched fault is corrected, the amplifier re-enables without operator intervention. In this case, motion may re-start unexpectedly.

For more information, See .

When operating the amplifier as a CAN or EtherCAT node, the use of CME or ASCII serial commands may affect operations in progress. Using such commands to initiate motion may cause network operations to suspend.

Operation may restart unexpectedly when the commanded motion is stopped.

**Use equipment as described.**

Operate amplifiers within the specifications provided in the relevant hardware manual or data sheet.

**FAILURE TO HEED THESE WARNINGS CAN CAUSE EQUIPMENT DAMAGE, INJURY, OR DEATH.**

## 1.5 Revision History

<b>Revision</b>	<b>Date</b>	<b>Applies to</b>	<b>Comments</b>
00	January 2014	CME 2 Software version 7.0	Changes include updated screen shots, information updates, and filter data.
01	March 2019	CME Software version 8.0	Incorporated new screenshots, added Frequency Analysis section
02	April 2019	CME Software version 8.0	Fixed minor issues



## 2 INTRODUCTION

### 2.1 Host Computer Requirements

#### 2.1.1 Computer and Operating System

Minimal hardware requirements:

- CPU: 1 GHz
- RAM: 1 GB

Operating Systems Supported: Windows 7, Windows 8 and Windows 10.

#### 2.1.2 Default File Locations

The default location for CME data files (ccx, ccm, etc.) is determined by the Operating System.

Windows 7, Windows 8 and Windows 10

C:\Users\Public\Public Documents\Copley Motion\CME2

#### 2.1.3 Serial Communications

- Standard RS-232 serial port or a USB-to-RS-232 adapter.
- Serial communication cable. See data sheet for part numbers.

#### 2.1.4 CAN Communications (With Copley CANopen Drives)

- CAN card. The following CAN card manufacturers are supported:
- Copley Controls CAN PCI card (CAN-PCI-02, CAN-PCIE-01, CAN-PCIE-02, CAN-USB-01, CAN-PC104-02)
- Kvaser
- CANopen network cable (see data sheet for part number and wiring instructions).

#### 2.1.5 EtherCAT Communications (With Copley EtherCAT Drives)

- Ethernet adapter dedicated to the EtherCAT network.
- EtherCAT network cable, (see data sheet for wiring instructions).

## 2.2 Overview

### 2.2.1 Setup and Tuning

Java based CME configuration software is powerful and intuitive. Comprehensive diagnostics, auto-tuning and advanced oscilloscope tools simplify system commissioning. Auto-phasing eliminates time consuming rewire-and-try for encoder/Halls/motor connections. CME automatically compensates for crossed wires eliminating the most common cause of startup headaches.

### 2.2.2 Indexing

Point-and-click to define up to 32 indexes or index sequences. Simply select the index/sequence and command GO. Index sequences can include motion, parameter changes, dwell times and I/O control. Any parameter can be assigned to a register for efficient control by a PLC.

Custom functions can be provided for complex applications. Install the Java "bean" and fill in the blanks. Copley also provides a flexible OEM programming environment. Copley Virtual Machine assembler/debugger enables the development of fast, compact control program.

### 2.2.3 Cam Tables

Camming is an effective way to produce repetitive motion synchronized to an external device. A pre-defined cam-table of slave positions is typically cycled through by a master encoder connected to the drive. The drive performs linear interpolation between points to minimize cam-table size.

NOTE: The feature descriptions in this manual may not apply to all Copley Controls amplifiers under all configurations. Significant differences between amplifier models are noted. See the relevant hardware manual or data sheet for more information.

## 2.3 Servo Operating Modes and Control Loops

Copley Controls drives use up to three nested control loops - current, velocity, and position - to control a motor in three associated operating modes. (Stepper drives operated in stepper mode, function as traditional open position loop stepper drives).

### 2.3.1 Control Loops Model

In position mode, the amplifier uses all three loops. As shown in the typical system illustrated below, the position loop drives the nested velocity loop, which drives the nested current loop.

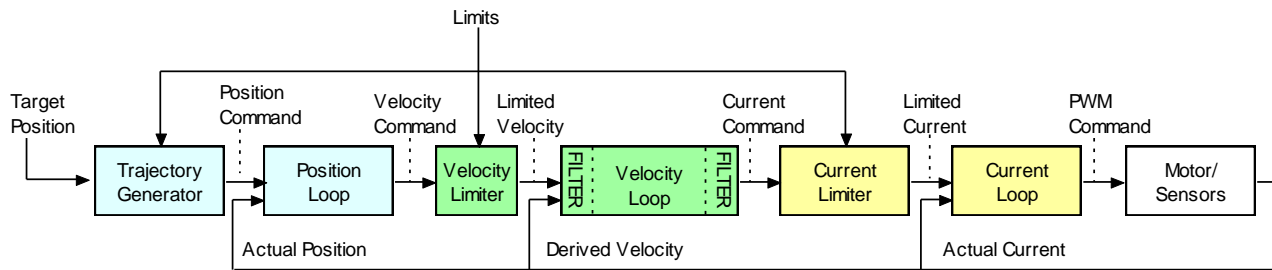

In velocity mode, the velocity loop drives the current loop. In current mode, the current loop is driven directly by external or internal current commands.

### 2.3.2 Basic Attributes of All Servo Control Loops

Loop Attribute	Description
Command input	Every loop is given a value to which it will attempt to control. For example, the velocity loop receives a velocity command that is the desired motor speed.
Limits	Limits are set on each loop to protect the motor and/or mechanical system.
Feedback	The nature of servo control loops is that they receive feedback from the device they are controlling. For example, the position loop uses the actual motor position as feedback.
Gains	These are constant values that are used in the mathematical equation of the servo loop. The values of these gains can be adjusted during amplifier setup to improve the loop performance. Adjusting these values is often referred to as tuning the loop.
Output	The loop generates a control signal. This signal can be used as the command signal to another control loop or the input to a power amplifier.

For more information on using CME to set up and tune control loops, see [Control Loops](#).

## 3 INSTALLATION, STARTUP, AND INTERFACE TOUR

### 3.1 Download and Install CME Software

1. Go to [www.copleycontrols.com](http://www.copleycontrols.com).
2. Navigate to **General Resources** under **Support**.
3. Click on **Software**.
4. Navigate to **CME Software Ver 8.0**.
5. Click on download icon  .
6. Add the email address to register. The link to download the software will be sent to the email address.
7. Click on the link and download the software.
8. Extract the contents of CME.zip.
9. Run Setup.exe and follow the instructions on the installer screens.

Note: It is recommended that all default installation values are accepted.

### 3.2 Special Notes for Windows 7, Windows 8 and Windows 10

#### 3.2.1 Installer

When the installer starts, Windows will display a dialog asking for permission to make changes to your computer. Click the button to allow the installer to continue, and CME will be installed.

#### 3.2.2 Set up CME to run as administrator

On some versions of Windows 7 , Windows 8 and Windows 10, CME will have to be set up to run as administrator to access the communications drivers (Serial, CANopen, EtherCAT).



1. Right-click the CME icon  on the desktop.
2. Choose **Properties** from the pop-up menu.

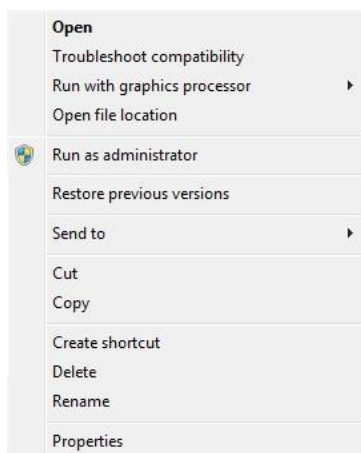

## Installation, Startup and Interface Tour

4. Click the **Advanced** button on the Properties dialog.

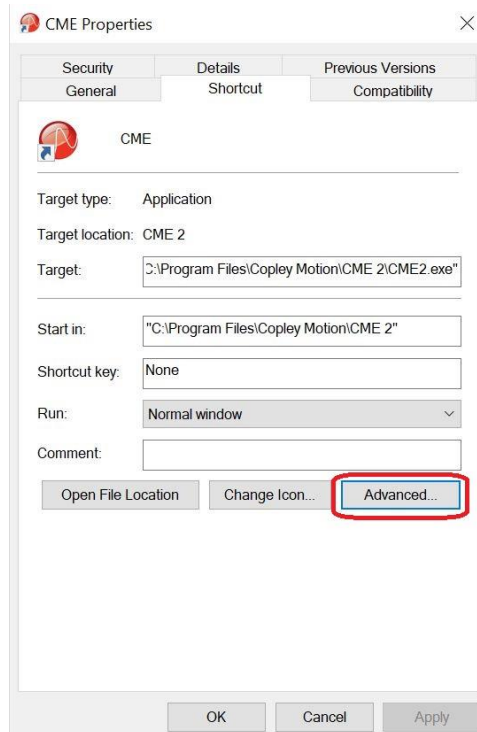

**Note: The name of the application has been changed from CME2 to CME, but the files will be downloaded to a "CME2" folder.**

5. Select **Run as Administrator**. Click **OK** to close the Advanced Properties dialog, then **OK** to close the Properties dialog.

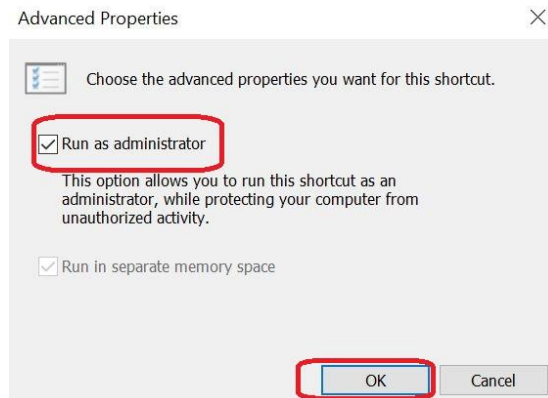

### 3.3 Start CME



1. Double-click the CME shortcut icon on the Windows desktop to start CME.

If communications were set up already, the CME Main Screen opens.

If communications were not set up, the Communications Wizard will be displayed as shown below:

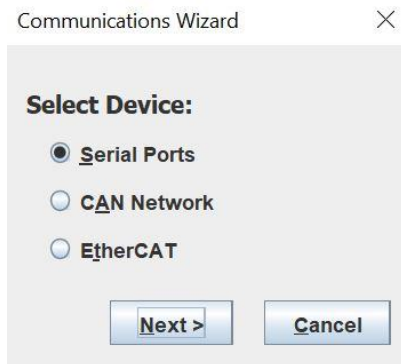

In this case, proceed to [Communications Wizard](#).

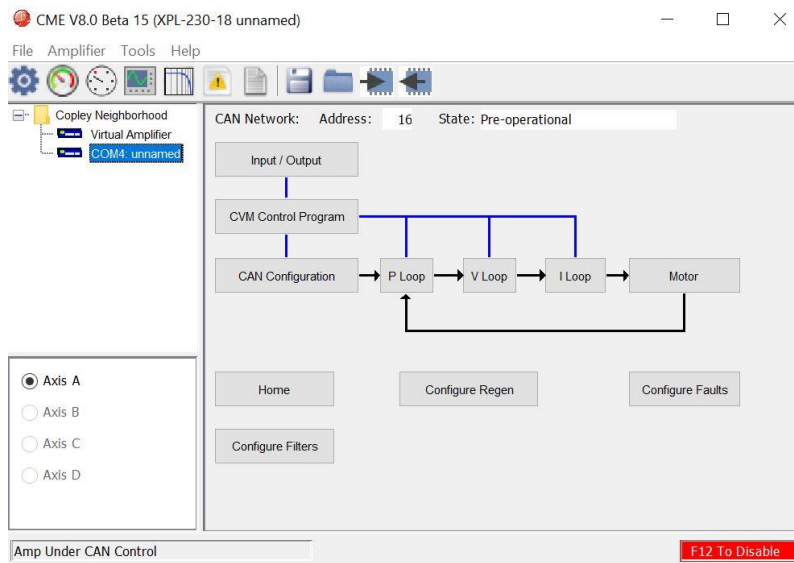

Example of a CME Main Screen after an amplifier has been selected.

### 3.4 Communications Wizard

#### 3.4.1 Configure Serial Ports

1. Start the **Communications Wizard**.

If communications have never been set up, the Communications Wizard will be displayed automatically when CME starts up.

If communications have already been set up, choose Tools→Communications Wizard.

Choose **Serial Ports** and click **Next**.

## Installation, Startup and Interface Tour

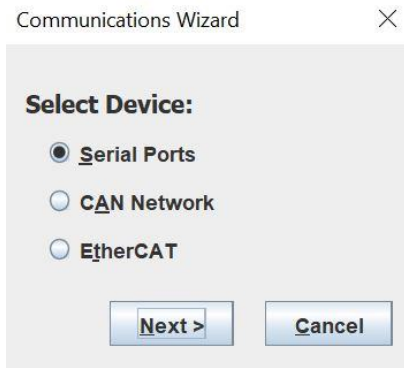

### 2. Select **Serial Ports**.

Select one or more serial ports from the **Available Ports** list.

Click **Add**.

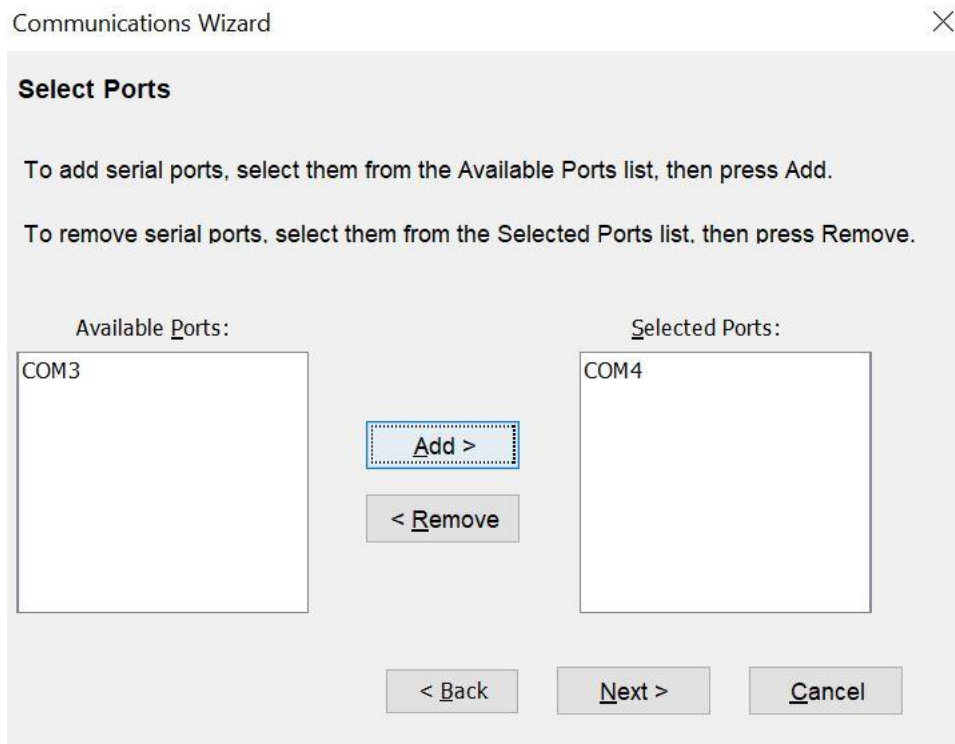

When all the desired ports have been added, click **Next**.

### 3. Configure serial ports.

- Select a port from the **Selected Ports** list.
- The **Baud Rate** will be displayed.
- Repeat for each selected port.

## Installation, Startup and Interface Tour

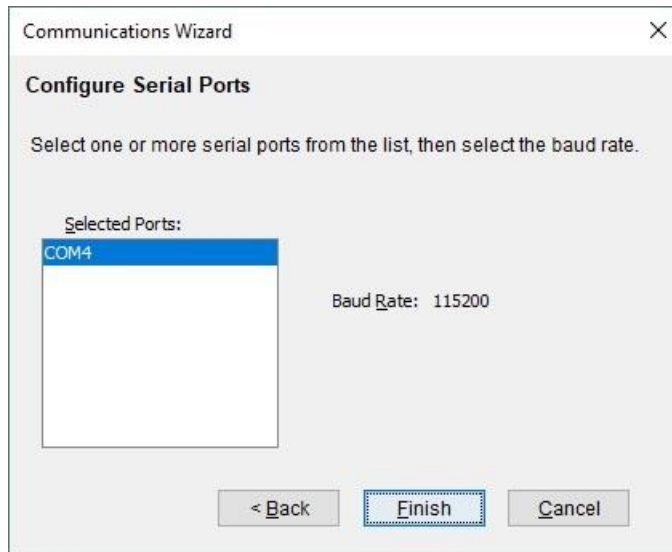

- Click **Finish** to save the settings.

### 3.4.2 Configure CANopen Network

1. Start the **Communications Wizard**.

If communications have never been set up, the Communications Wizard will be displayed automatically when CME starts up.

If communications have already been set up, choose Tools→Communications Wizard.

Choose **CAN Network** and click **Next**.



2. Configure CANopen Network
  1. Select the **CAN Card** from the list.
  2. Enter the channel number (0 for single channel CAN cards) in **Channel**.
  3. Select the **Bit Rate** (1Mbit/s Drive default)

## Installation, Startup and Interface Tour

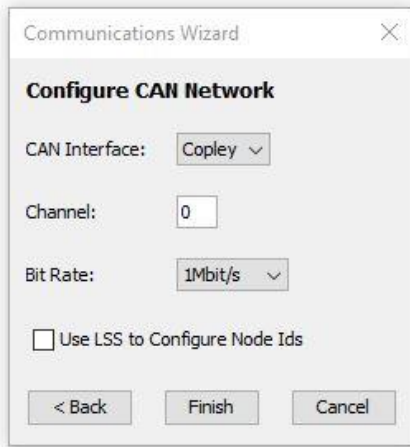

4. Click **Finish** to save the settings.

Notes:

1. The CAN Card list only shows the CAN cards that are supported by CME and are properly installed on the PC.
2. LSS can be used if all nodes are 0 and no switch is being used.

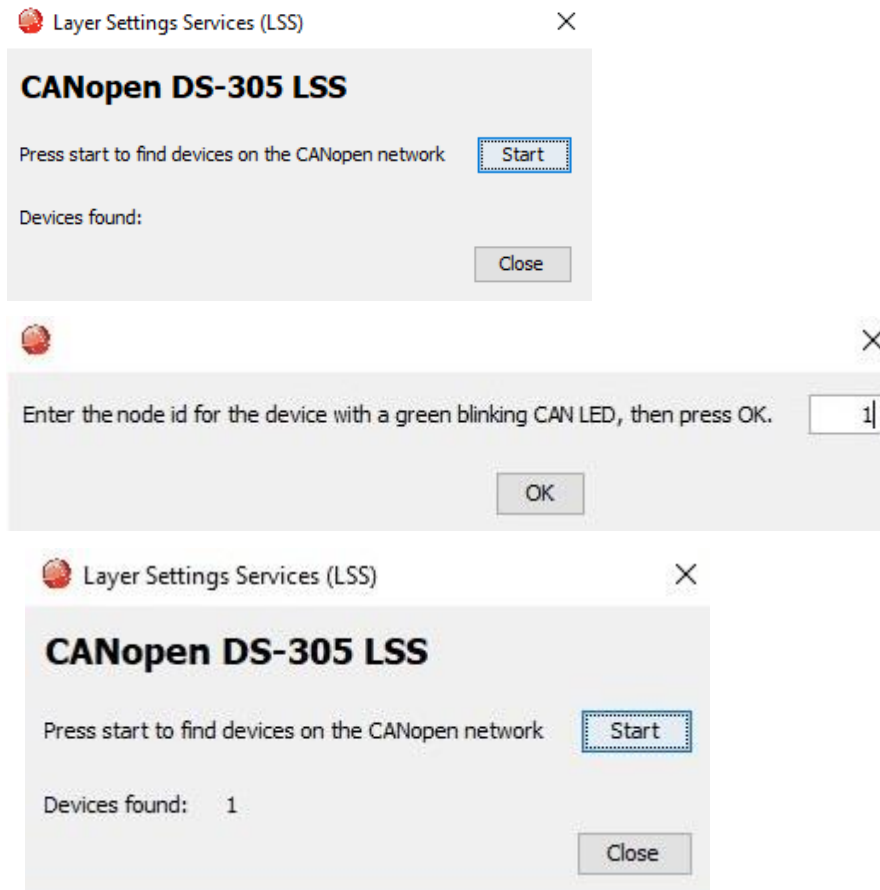



### 3.4.3 Configure EtherCAT Network

1. Start the Communications Wizard.

If communications have never been set up, the **Communications Wizard** will be displayed automatically when CME starts up.

If communications have already been set up, choose Tools→Communications Wizard.

Choose **EtherCAT** and click **Next**.

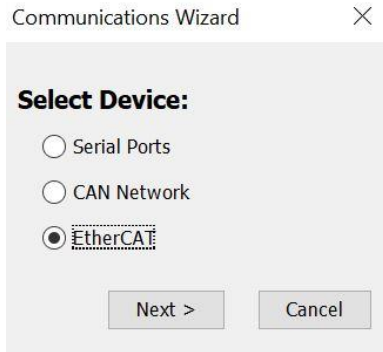

Select the appropriate **Network Adapter**.

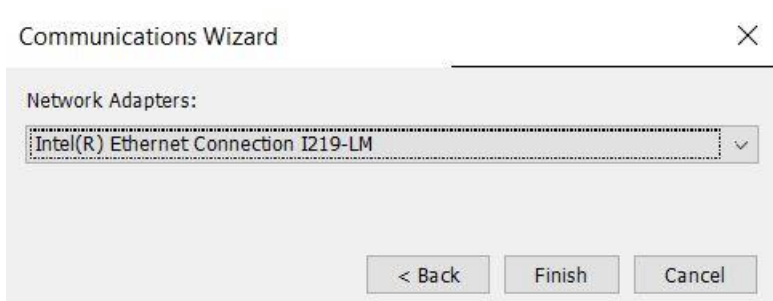

Click **Finish** to save the settings.

## 3.5 Connect to an Amplifier

Choose an amplifier by clicking on its name in the Copley Neighborhood. When there is only one amplifier, CME will automatically connect on startup.

### Serial port

CME V8.0 Beta 15 (XPL-230)

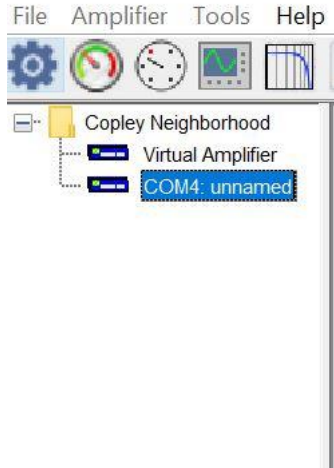

### EtherCAT network

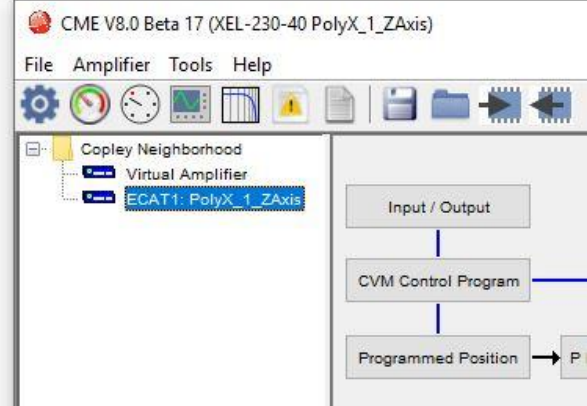

### CAN network

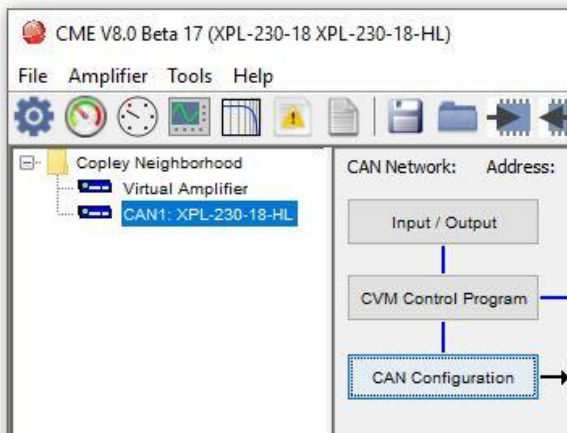

### 3.6 Rename an Amplifier

1. Navigate to Node.
2. Choose Main Menu **Amplifier**→**Rename** to open the Rename Amplifier screen.

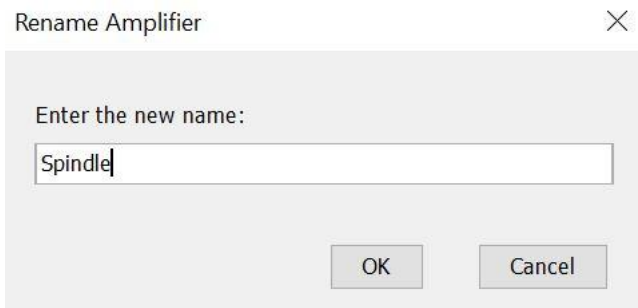
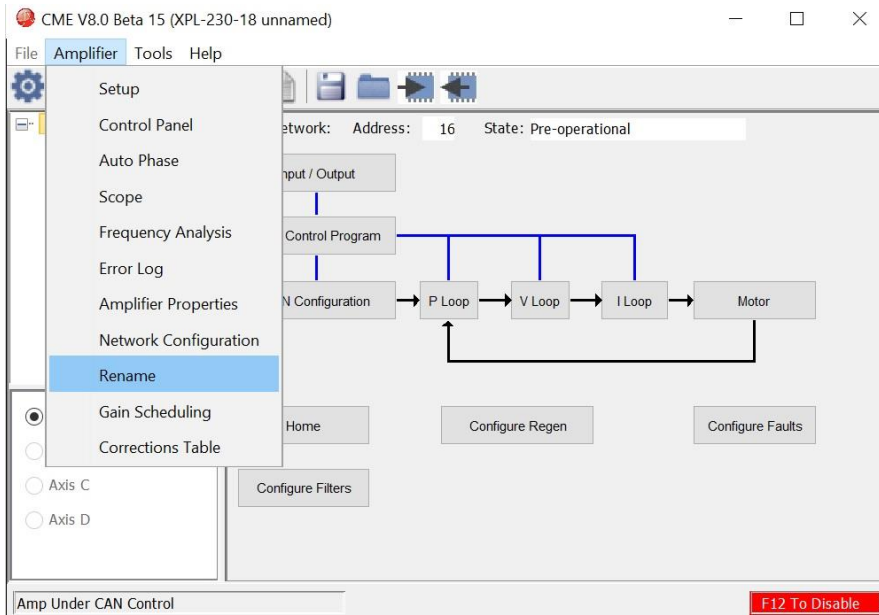

3. Enter the new name and click **OK** to close the screen. The Drive name is now in FLASH and can be seen in the tree.

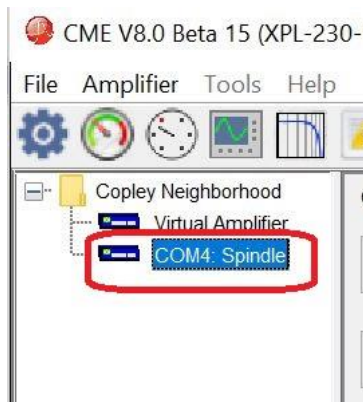

### 3.7 CME Interface Tour

CME features are called out in the diagram below. Screen details vary depending on amplifier

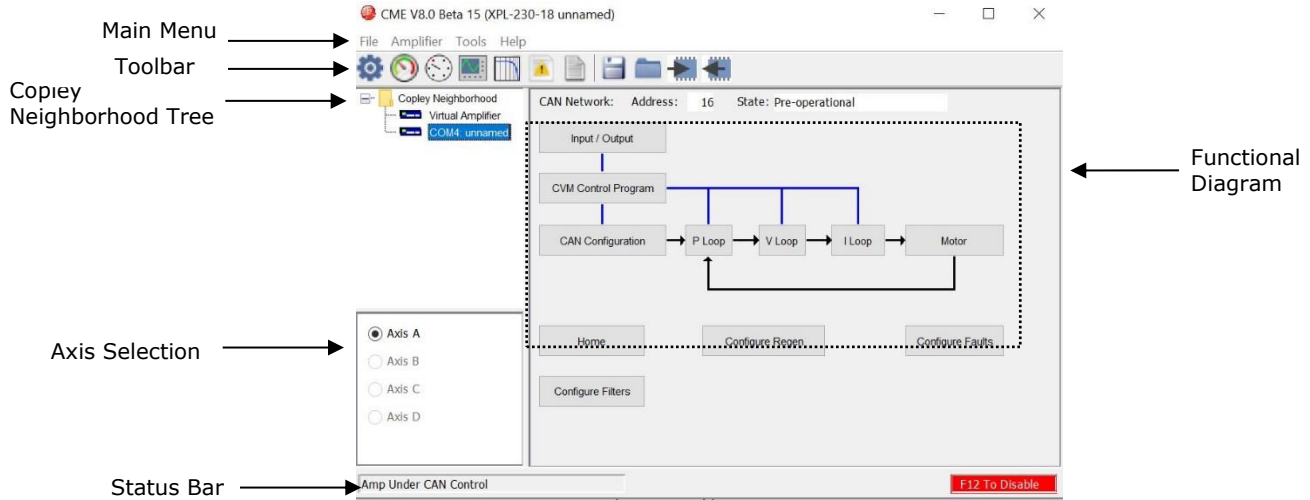

#### 3.7.1 Main Menu

##### File Menu

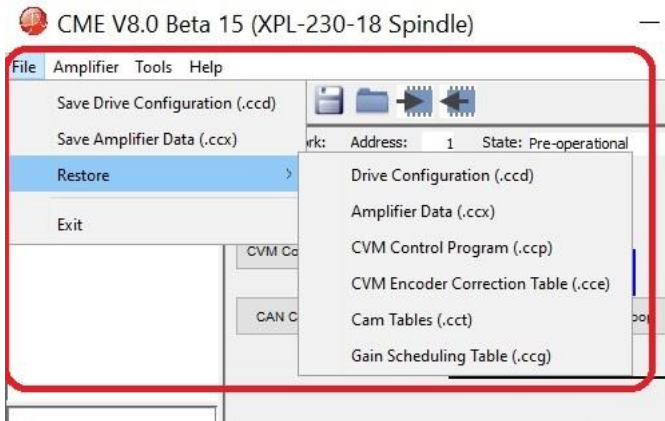

Option	Type	Description	For More Information
<b>Save Drive Configuration</b>	<b>.ccd</b>	Saves the entire contents of amplifier to a single drive configuration file. This includes all drive parameters, CVM flash space (CVM programs, gain scheduling, etc.)	<b>Error! Not a valid result for table.</b>
<b>Save Amplifier Data</b>	<b>.ccx</b>	Saves the parameters of the amplifier RAM to a file on disk.	

## Installation, Startup and Interface Tour

<b>Save As→Single Axis</b>	<b>.ccx</b>	For multi-axis drives only: saves one axis to a file on disk. (Available only for older drives)	
<b>Save As→V4.1 Format</b>	<b>.ccx</b>	Saves amplifier data file in format usable by CME 2 Version 4.1. (Available only for older drives)	
<b>Copy Axis</b>		For multi-axis drives only: copies the setting from one axis to another.	
<b>Restore→Drive Configuration</b>	<b>.ccd</b>	Restores the entire contents of amplifier to a single drive configuration file. This includes all drive parameters, CVM programs and gain schedules.	
<b>Save MACRO File</b>	<b>.ccd</b>	(MACRO amplifiers only) Saves amplifier setup and tuning parameters in a format that can be read by Delta Tau controllers.	
<b>Restore→Amplifier Data</b>	<b>.ccx</b>	Restores the parameters of the amplifier file from disk to amplifier RAM.	
<b>Restore→Single Axis</b>	<b>.ccx</b>	For multi axis drives only: restores contents of an amplifier file to only one axis	
<b>Restore→CVM Control Program</b>	<b>.ccp</b>	Restores a CVM program from a file to the CVM Flash.	
<b>Restore→CVM Encoder Correction Table</b>	<b>.cce</b>	Restores a correction table from disk to the CVM flash.	
<b>Restore→Cam Tables</b>	<b>.cct</b>	Restores a Cam Table file (.cct).	
<b>Restore→Gain Scheduling Table</b>	<b>.ccg</b>	Restores Gain Scheduling Table from a file (.ccg).	<a href="#">Gain Scheduling</a>
<b>Exit</b>		Closes CME.	

## Amplifier Menu

## Installation, Startup and Interface Tour

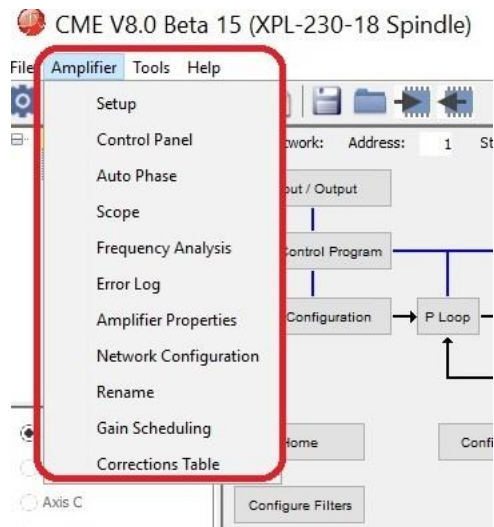

Option	Description	For more information
<b>Setup</b>	Opens Setup screen	<a href="#">Setup</a>
<b>Control Panel</b>	Opens Control Panel	<a href="#">Control Panel</a>
<b>Auto Phase</b>	Opens Auto Phase tool	<a href="#">Motor Phasing</a>
<b>Scope</b>	Opens Scope Tool screen	<a href="#">Scope</a>
<b>Frequency Analysis</b>	Opens Frequency Analysis tool	<a href="#">Frequency Analysis</a>
<b>Error Log</b>	Opens Error Log screen	<a href="#">Error Log</a>
<b>Amplifier Properties</b>	Displays basic amplifier properties	<a href="#">Amplifier Properties</a>
<b>Network Configuration</b>	Opens the Network Configuration screen	<a href="#">Network Configuration</a>
<b>Rename</b>	Prompts for new amplifier name	<a href="#">Rename an Amplifier</a>
<b>Gain Scheduling</b>	Opens Gain Scheduling screen	<a href="#">Gain Scheduling</a>

**Tools Menu**

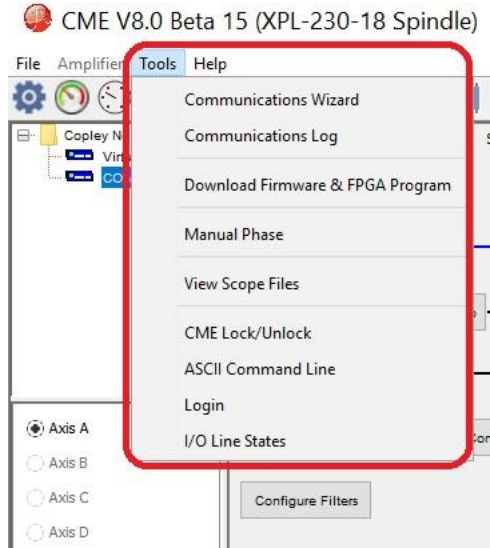

<b>Selection</b>	<b>Description</b>	<b>For More Information</b>
<b>Communications Wizard</b>	Starts sequence of prompts to set up communications	<a href="#">Communications Wizard</a>
<b>Communications Log</b>	Opens Communications Log	<a href="#">Communications Log</a>
<b>Download Firmware &amp; FPGA Program</b>	Starts prompts to download firmware from disk to amplifier	<a href="#">Firmware Download</a>
<b>Manual Phase</b>	Opens Manual Phase tool	<a href="#">Manual Phase</a>
<b>View Scope Files</b>	Opens Trace Viewer window	<a href="#">Scope Trace Files</a>
<b>CME Lock/Unlock</b>	Opens screen for locking and unlocking CME functionality	<a href="#">Lock/Unlock CME</a>
<b>ASCII Command Line</b>	Opens screen to accept ASCII format commands	<a href="#">Copley ASCII Interface</a>
<b>Login</b>	Opens Login screen which prompts to enter credentials for a local installation	
<b>I/O Line States</b>	Opens I/O Line States window, showing high/low status of the amplifier's inputs and outputs	





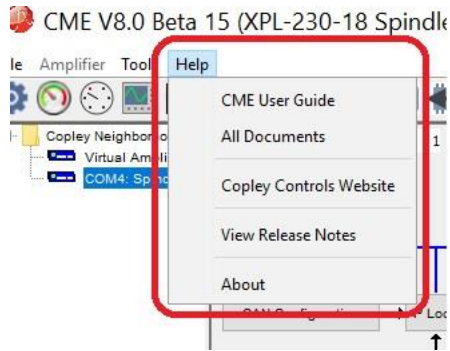





## Installation, Startup and Interface Tour

### Help Menu



Selection	Description
<b>CME User Guide</b>	Opens this manual
<b>All Documents</b>	Opens the Doc folder in the CME installation folder (typically c://Program Files/Copley Motion/CME2/Doc). This folder contains all the related documents that were installed with CME.
<b>Copley Controls Website</b>	Opens default web browser with pages from Copley Controls' website
<b>View Release Notes</b>	Opens latest CME release notes in a text viewer
<b>About</b>	Displays CME version information

### 3.7.2 Tool Bar

Icon	Name	For More Information
	Setup	<a href="#">For initial setup</a>
	Control Panel	<a href="#">Control Panel</a>
	Auto Phase	<a href="#">Motor Phasing</a>
	Scope	<a href="#">Scope</a>
	Frequency Analysis	<a href="#">Frequency Analysis</a>
	Error Log	<a href="#">Error Log</a>
	Amplifier Properties	<a href="#">Amplifier Properties</a>
	Save to disk	<a href="#">Data Management Tools</a>
	Restore from disk	
	Save to flash	
	Restore from flash	



### 3.7.3 Functional Diagram

The functional diagram, shown below, provides button-click access to most of the screens used to configure an amplifier. It also indicates the flow of control from input, across all active control loops, to motor. Only those control loop buttons that are appropriate to the amplifier and operational mode appear on the diagram.

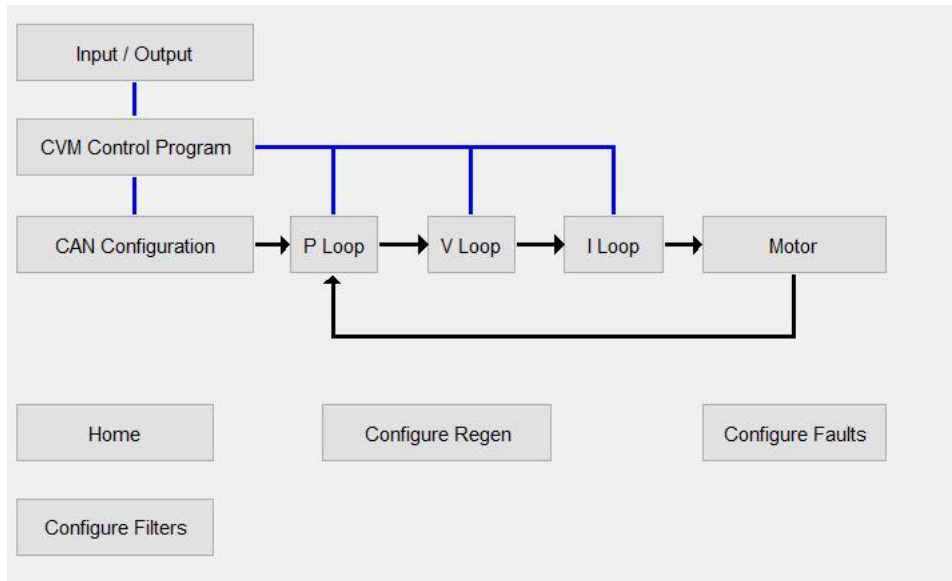

Button	Description	For More Information
Input/Output	Opens Input/ Output screen	<a href="#">Digital Inputs and Outputs</a>
CVM Control Program	Opens Copley Virtual Machine screen	Copley Indexer Program User's Guide.
Input Command	Opens screen for configuring the input command Button text varies depending on the selected control loop input	<b>Error! Not a valid result for table.</b>
Control Loops	Each opens a control loop configuration screen	<a href="#">Control Loops</a>
Motor	Opens the Motor screen	<a href="#">Motor</a>
Home	Configure and test homing	<a href="#">Homing</a>
Configure Regen	Opens Regen Settings screen	<a href="#">Regen Resistor Configuration</a>
Configure Faults	Opens Fault Configuration screen	<a href="#">Fault</a>
Configure Filters	Opens Filter Configuration screen	<a href="#">Filters</a>
Encoder Correction	(Stepper amplifier with encoder only) Opens Encoder Correction screen	<a href="#">Encoder Correction</a>
Detent	(Stepper amplifier only) Opens stepper amplifier Advanced Tuning screen	<a href="#">Detent Compensation Gain</a>
Position Limits	(Stepper amplifier with encoder only) Opens Position Limits screen	<a href="#">Position Limits (Stepper Amplifier)</a>

### 3.7.4 CAN Information and Status Bar

#### 3.7.4.1 CAN Information

The Main screen displays the basic CAN information.

The example below shows CAN information:

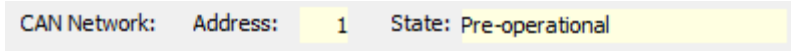

The Address field shows the amplifier’s present CAN address. For more information, see [Network Configuration](#). When the Position Loop Input is set to CAN, the State field shows the state of the amplifier’s CANopen state machine (for more information, see Copley Control’s CANopen Programmer’s Manual).

#### 3.7.4.2 Status Bar

The status bar describes the amplifier control status as shown below. It also includes a reminder that pressing the F12 function key while CME is running disables the amplifier.

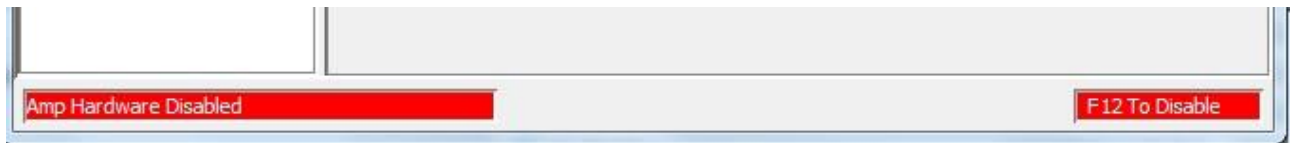

## 4 AMPLIFIER SETUP

### 4.1 Setup Procedure

#### 4.1.1 Warnings and Notes

NOTE: To software disable the amplifier at any time while running CME, press function key **F12**. Also, the amplifier's enable input can be used to disable the amplifier.



**DANGER**

**DANGER: Hazardous voltages.**

Exercise caution when installing and adjusting.

Do not make connections to motor or drive with power applied.

**Risk of unexpected or uncontrolled motion with CME in CAN mode.**

CME can be used while the amplifier is under CAN or EtherCAT control. However, some extreme changes made with CME could cause unexpected or uncontrolled motion.

**Failure to heed these warnings can cause equipment damage, injury, or death.**



**WARNING**

**Spinning motor with power off may damage amplifier.**



Do not spin motors with power off. Voltages generated by a motor can damage an amplifier.

**Failure to heed this warning can cause equipment damage.**

## Amplifier Setup

1. Prepare for setup.
  - a. Understand the procedure's [Warnings and Notes](#).
  - b. Verify that the amplifier power is OFF.
  - c. Verify wiring and connections.
  - d. Make sure motor is securely fastened with no load connected.
  - e. Apply power to the amplifier. For off-line amplifiers apply 24V only. For DC amplifiers apply AUX HV only.

2. Start CME and enter Setup parameters.

- a. Double-click the CME icon  on the desktop to start CME.  
If necessary, connect to an amplifier from the list in the Copley Neighborhood tree.
- b. If the **Setup** screen does not appear, click the **Setup** button .
- c. Choose:

In most cases, click **Change Settings**  to [Change Setup Settings](#). Then proceed to Step 3 of this Setup Procedure.

OR

To load a .ccx file, see [Copy Drive Data](#).

To load a .ccd file, see [Copy Drive Data](#).

2. Enter Motor parameters. See [Motor Data](#).
3. Configure digital I/O. See [Digital Inputs and Outputs](#).

4. Configure the command input. See [Command Inputs](#).

- a. Based on the command source settings in the **Setup** screen, one of the following buttons will appear in the main screen.





- b. Click the appropriate button to configure the amplifier's command input.

NOTE: If the amplifier is to run CVM programs or in Camming mode see the relevant documents.

- c. After setting command input parameters, Click **Close**.

5. Configure Homing. See [Homing](#).
6. Configure an optional regen resistor. See [Regen Resistor Configuration](#).
7. Configure faults. See [Faults](#).

## Amplifier Setup

8. Phase and jog the motor.
  - a. Apply AC or HV power.
  - b. Phase  the motor. See [Auto Phase](#).
  - c. Jog/move the motor to verify that the amplifier can drive the motor. See [Jog Mode](#).
  
9. Tune the control loops. See [Control Loops](#).
  - a. Tune [Control Loop I](#) (Current).
  - b. Tune [Control Loop V](#) (Velocity).
  - c. Tune [Control Loop P](#) (Position).
  
10. Set gains and limits for stepper mode (stepper only)
  - a. If tuning a stepper amplifier in stepper mode:
    - Set Position Limits in Stepper Mode. See [Position Limits \(Stepper Amplifier\)](#)
    - If using Encoder Correction, see [Encoder Correction](#).
    - Tune [Detent Compensation Gain](#).
  
11. Test with load attached.
  - a. On the CME Main screen, click **Save to Flash**.
  - b. Remove amplifier power.
  - c. Attach load.
  - d. Reconnect amplifier power.
  - e. If necessary, re-tune velocity and position loops.
  - f. On the CME Main screen, click **Save to Flash** .
  - g. On the CME Main screen, click **Save to Disk**  (for backup or duplication).
  - h. The amplifier tuning procedure is complete.

NOTE: To copy the results of this setup to other amplifiers, see [Drive Configuration](#) or [Copy Drive Data](#).

## 5 SETUP

### 5.1 Overview

The Setup Wizard is used to set up the parameters that define the fundamental characteristics of the system. This is where the motor, feedback and operating mode are setup. The setup can be done three different ways: manually change settings, load settings from a ccx file or load settings from a ccd file. Each of these methods are explained in this section.

1. Click  to open the Setup screen.

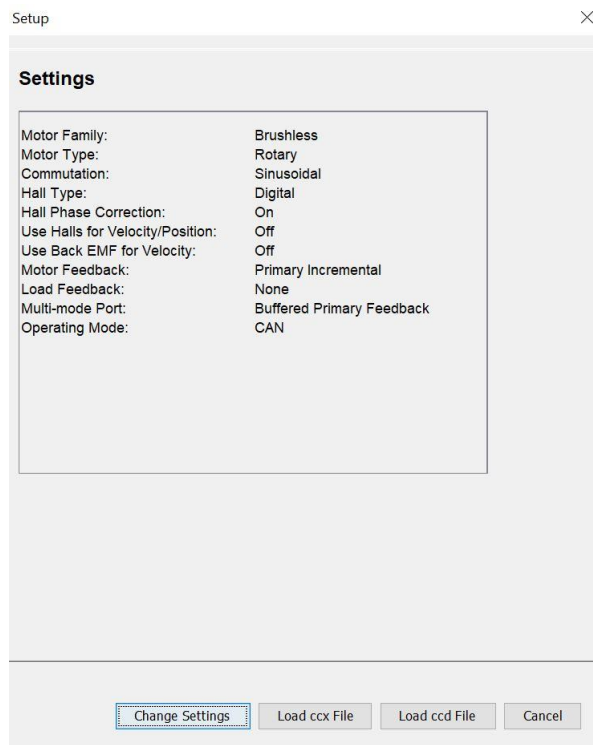

2. Review settings.
3. Choose:

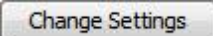
Click **Change Settings**  to manually [Change Setup Settings](#).

OR

If you have a .ccx file, see [Copy Drive Data](#).

OR

If you have a .ccd file, see [Copy Drive Data](#).

4. To accept the displayed settings, click **Cancel** .

## 5.2 Change Setup Settings

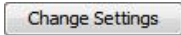
1. On the Setup screen, click **Change Settings**  to manually change all Setup settings. Use the **Back** and **Next** buttons to navigate between screens. Screen details vary depending on amplifier model and mode selection.
2. Set Motor Options.

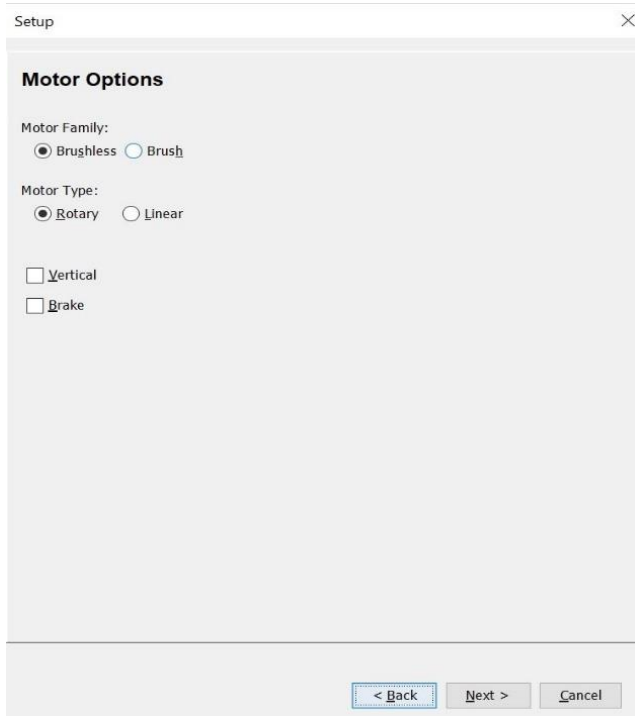

Setup

**Motor Options**

Motor Family:  
 Brushless  Brush

Motor Type:  
 Rotary  Linear

Vertical  
 Brake

< Back   Next >   Cancel

3. Click **Next** to go to **Feedback Options**.

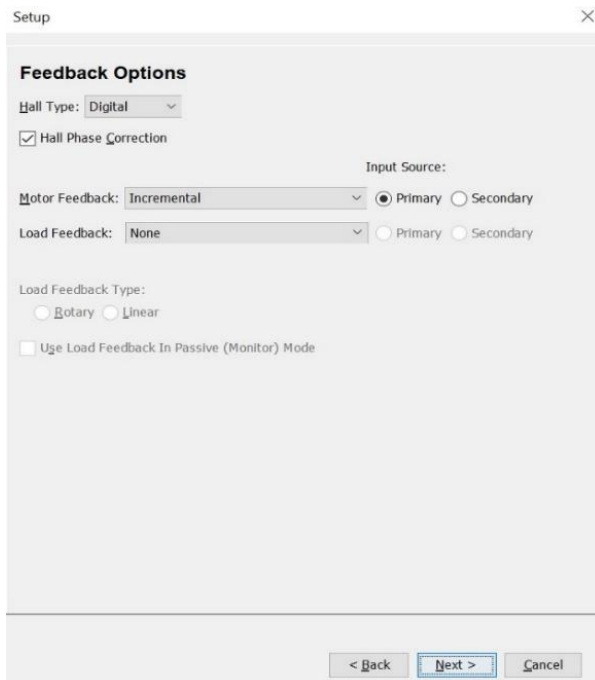

Setup

**Feedback Options**

Hall Type: Digital

Hall Phase Correction

Input Source:  
 Primary  Secondary

Motor Feedback: Incremental  Primary  Secondary

Load Feedback: None  Primary  Secondary

Load Feedback Type:  
 Rotary  Linear

Use Load Feedback In Passive (Monitor) Mode

< Back   Next >   Cancel

<b>Setting</b>	<b>Description</b>
Hall Type	Select Hall type: None, Digital, or Analog
Hall Phase Correction	If selected, will enable error checking between hall sensors and encoder phase angle.
Motor Feedback	Select type and source of motor feedback. <ul style="list-style-type: none"> <li>• None: No motor encoder.</li> <li>• Primary Incremental: Incremental encoder on primary feedback connector.</li> <li>• Secondary Incremental: Incremental encoder on multi-mode port.</li> <li>• Panasonic Incremental A Format</li> <li>• SSI</li> <li>• EnDat</li> <li>• BiSS</li> <li>• Absolute A</li> <li>• Tamagawa Absolute A</li> <li>• Panasonic Absolute A Format</li> <li>• Panasonic Incremental A Format</li> <li>• Sanyo Denki Absolute A</li> <li>• Analog: Analog encoder on primary feedback connector.</li> <li>• Low Frequency Analog</li> <li>• Resolver: Resolver (-R) version of a Copley Controls amplifier on primary feedback connector.</li> </ul> Additional encoder types are supported by certain Copley Controls amplifier models. See the amplifier data sheet for more information.
Load Feedback	Select type and source of load feedback. <ul style="list-style-type: none"> <li>• None: No load feedback</li> <li>• Primary Incremental: Incremental encoder on primary feedback connector.</li> <li>• Secondary Incremental: Incremental encoder on multi-mode Port.</li> <li>• Analog: Analog encoder on primary feedback connector.</li> </ul>
Load Feedback Type	Select the type of load feedback: <ul style="list-style-type: none"> <li>• Rotary</li> <li>• Linear</li> </ul>
Use Load Feedback in Passive (Monitor) Mode	When this is checked, the position of the load encoder will be reported by the passive load position variable but will not be used to control the position of the axis.
<b>Stepper Drives Only</b>	
Motor Encoder	Select the encoder type: <ul style="list-style-type: none"> <li>• None</li> <li>• Primary incremental</li> <li>• Absolute types</li> </ul>
Run in Servo Mode	(Requires encoder) Amplifier operates as a true, closed loop, servo amplifier controlling a stepper motor.
Enable Encoder Correction	(Requires encoder) Amplifier runs as a stepper drive; encoder feedback is used to correct positional errors. See <a href="#">Encoder Correction</a>



## Setup

- Click **Next** to go to **Motor Feedback**.

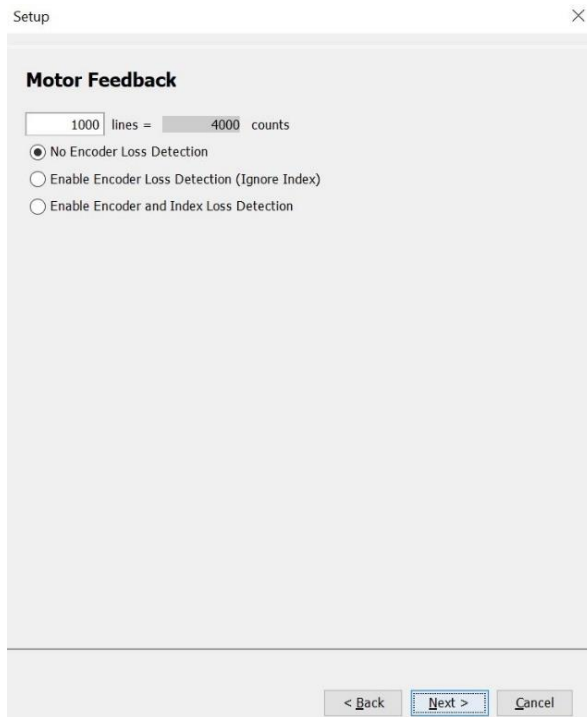

The screenshot shows a dialog box titled "Setup" with a close button (X) in the top right corner. The main heading is "Motor Feedback". Below the heading, there is a text input field containing "1000" followed by "lines =", a slider bar, and "4000 counts". Underneath, there are three radio button options: "No Encoder Loss Detection" (which is selected), "Enable Encoder Loss Detection (Ignore Index)", and "Enable Encoder and Index Loss Detection". At the bottom of the dialog, there are three buttons: "< Back", "Next >" (highlighted with a blue border), and "Cancel".

## Feedback Parameters, Rotary

Details for serial encoders can be found in the Serial Encoder Guide.

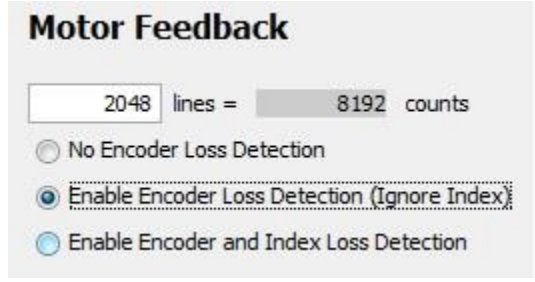
Feedback Type	Parameters/Actions
<b>Incremental</b>	<p>In the Motor Encoder <b>lines</b> or Position Encoder <b>lines</b> field, enter the number of encoder lines (see encoder or motor data sheet). As indicated by the <b>counts</b> field, the number of encoder counts per revolution is equal to 4 x the number of lines. Enable Encoder Loss Detection and/or Index Loss detection if desired.</p>  <p>The screenshot shows the "Motor Feedback" dialog box with the "lines" field set to "2048" and the "counts" field set to "8192". The "Enable Encoder Loss Detection (Ignore Index)" radio button is selected and highlighted with a dashed border. The other two radio buttons are unselected.</p>

Setup

<p><b>Analog</b></p>	<p>In <b>Fundamental Lines</b>, enter the number of fundamental encoder lines (see encoder or motor data sheet). As indicated by the Fundamental Counts field, the number of fundamental encoder counts per revolution is equal to 4 x the number of Fundamental Lines.</p> <div data-bbox="456 285 922 632"> <p><b>Motor Feedback</b></p> <p>Fundamental Lines: <input type="text" value="512"/></p> <p>Fundamental Resolution: 2048</p> <p>Interpolation: <input type="text" value="4096"/></p> <p>Interpolated Counts: 8388608</p> </div> <p>Optionally modify the encoder resolution by changing the <b>Interpolation</b> value. The interpolated resolution (Interpolated Counts Per Rev) is the product of Fundamental Counts value and the Interpolation value.</p>
<p><b>Resolver</b></p>	<p>Optionally modify the feedback resolution by changing the value in <b>Counts Per Rev</b>. Default: 16384.</p> <div data-bbox="456 814 808 909"> <p>Resolver</p> <p><input type="text" value="16384"/> counts per rev</p> </div>
<p><b>Halls</b></p>	<p>With amplifier set to <b>Use Halls for Velocity/Position</b>, optionally increase the counts per rev ratio by incrementing the <b>Halls Count Multiplier</b>.</p> <div data-bbox="456 999 1252 1257"> <p>Motor Halls</p> <p>Hall Count Multiplier: <input type="text" value="1"/></p> <p>Counts per Rev.: <input type="text" value="24"/></p> <p><input type="button" value="Default"/></p> </div>

**Feedback Parameters, Linear**

Details for serial encoders can be found in the Serial Encoder Guide.

Feedback Type	Parameters/Actions
<p><b>Incremental</b></p>	<p>Choose units and then enter the <b>Encoder Resolution</b> (see encoder or motor data sheet). Enable Encoder Loss Detection and/or Index Loss detection if desired.</p> <div data-bbox="456 1566 1133 1856"> <p><b>Motor Feedback</b></p> <p>Resolution: <input type="text" value="1"/> <input type="radio"/> mm <input checked="" type="radio"/> <math>\mu</math>m <input type="radio"/> nm</p> <p><input type="radio"/> No Encoder Loss Detection</p> <p><input checked="" type="radio"/> Enable Encoder Loss Detection (Ignore Index)</p> <p><input type="radio"/> Enable Encoder and Index Loss Detection</p> </div>
<p><b>Analog</b></p>	<p>Enter the <b>Fundamental Pitch</b> (distance between encoder lines; see encoder or motor data sheet). As indicated by the Fundamental Resolution field, Fundamental</p>

## Setup

	<p>Pitch divided by four gives Fundamental Resolution. The interpolated resolution is the dividend of Fundamental Resolution value/Interpolation value. Optionally modify the Interpolated Resolution by changing the <b>Interpolation</b> value.</p> <div data-bbox="467 247 1203 611"><h3>Motor Feedback</h3><p>Fundamental Pitch: <input type="text" value="20"/> <input type="radio"/> mm <input checked="" type="radio"/> um <input type="radio"/> nm</p><p>Fundamental Resolution: 5 um</p><p>Interpolation: <input type="text" value="1024"/> ▼</p><p>Interpolated Resolution: 0.0048828125 um</p></div>
<b>Low Frequency Analog</b>	<p>Normally used with ServoTube, Pole Pitch is the distance between poles in a pole pair, as entered in the Magnetic Pole Pair Length field on the Motor tab. The interpolated resolution is the dividend of Pole Pitch/Counts per pole value, expressed in micrometers. Optionally modify the resolution by changing the <b>Counts/Pole</b> value. Click <b>Restore Default</b> to restore default Counts/Pole.</p> <div data-bbox="467 772 1203 1136"><h3>Motor Feedback</h3><p>Fundamental Pitch: <input type="text" value="20"/> <input type="radio"/> mm <input checked="" type="radio"/> um <input type="radio"/> nm</p><p>Fundamental Resolution: 5 um</p><p>Interpolation: <input type="text" value="1024"/> ▼</p><p>Interpolated Resolution: 0.0048828125 um</p></div>

### 5. Click Next to go to **Load Feedback**.

### Load Feedback

Resolution:  um

No Encoder Loss Detection  
 Enable Encoder Loss Detection (Ignore Index)  
 Enable Encoder and Index Loss Detection

### Ratio

Motor Turns:  Load Turns:

< Back **Next >** Cancel

## Setup

### 6. Click **Next** to go to **Brake/Stop** tab.

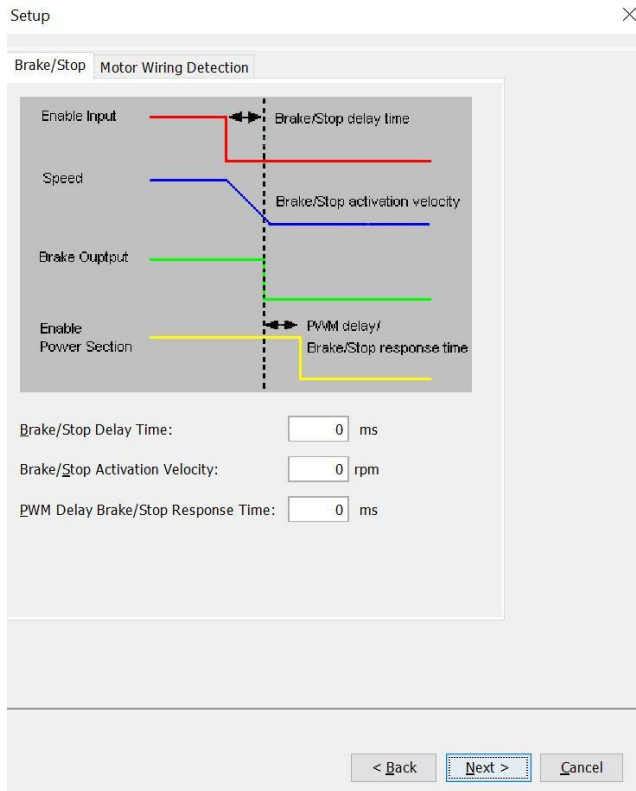

Many control systems employ a brake to hold the axis when the amplifier is disabled. On brake-equipped systems, disabling the amplifier by a hardware or software command starts the following sequence of events.

1. The motor begins to decelerate (at Abort Deceleration rate in position mode or Fast Stop Ramp rate in velocity mode). At the same time, the Brake/Stop Delay Time count begins. This allows the amplifier to slow the motor before applying the brake.
2. When response time has passed, the amplifier's output stages are disabled. This delay ensures the brake has time to lock in before disabling the power section.

Systems that do not employ brakes may still come to a controlled stop. On such systems, disabling the amplifier by a hardware or software command initiates the motor deceleration (at Abort Deceleration rate in position mode or Fast Stop Ramp rate in velocity mode). After the Brake/Stop Delay Time and any PWM delay response time, the drive will be disabled. This allows the amplifier to bring the motor to a controlled stop before disabling the drive.

Note: This feature is not available when the amplifier is configured for current mode. In this mode, the amplifier output turns off and the brake output activates immediately when the disable command is received.

Parameter	Description
Brake/Stop Delay Time	Time taken to stop the system. Range of accepted values: 0 to 10,000 mS
Brake/Stop Activation Velocity	Typical values are low to protect the brake mechanism (a few rpm). "0" disables velocity-based brake activation.
PWM Delay Brake/Stop Response Time	Time delay taken for the brake to engage after brake output is activated. Range of accepted values: 0 to 10,000 mS

## Setup

- Click on **Motor Wiring Detection** tab.

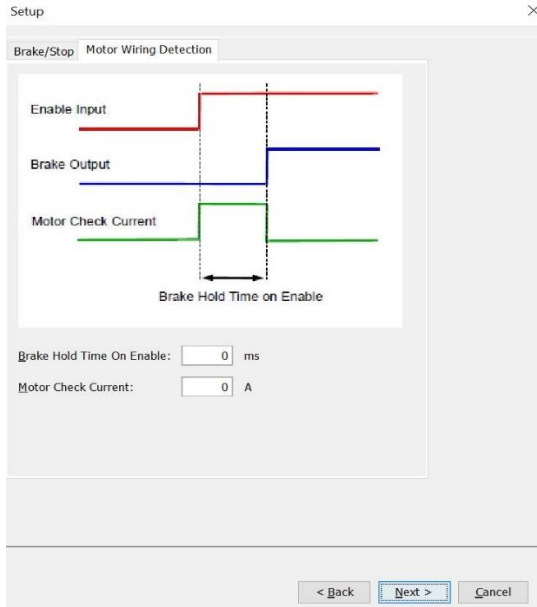

On some drives, the amplifier can check for a disconnected motor. Upon enable, the amplifier will apply current to the motor windings, while keeping the brake engaged for the brake hold time. If the current vector cannot be applied, then a motor disconnected fault will occur, and the brake will not be released. If the motor is connected, the brake will be released after the brake hold time expires.

Parameter	Description
Brake Hold Time on Enable	The time during which the amplifier is enabled, but the brake is engaged and the current is applied to the motor windings.
Motor Check Current	The amount of current to apply to the motor windings.

- Click **Next** to go to **Operating Mode Options**.

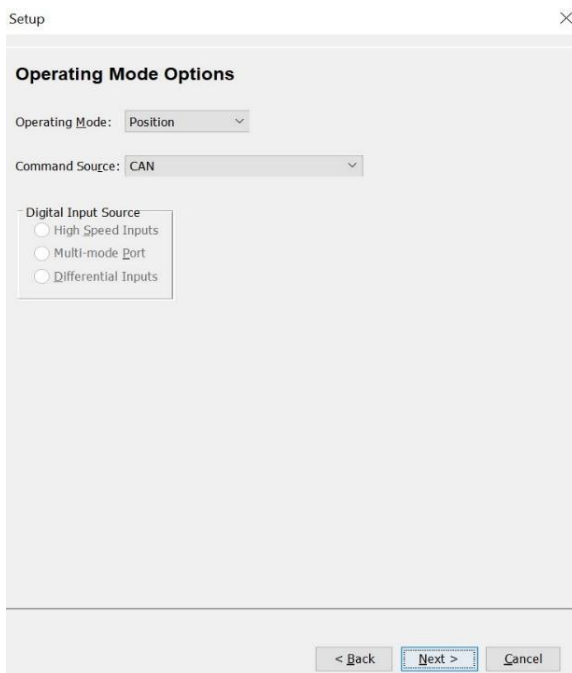

Setting	Description
Operating Mode	Choose the mode of operation: Current, Velocity, or Position. See <a href="#">Control Loops</a>
Command Source	<p>Choose the command input source (see <b>Error! Not a valid result for table.</b>):</p> <ul style="list-style-type: none"> <li>• Analog Command (Current &amp; Velocity Modes): Analog voltage provides command input.</li> <li>• PWM command (Current and Velocity modes): Digital pulse-width modulated signal provides command input. Command input is provided via the chosen Input Source (below).</li> <li>• Function Generator (Current, Velocity &amp; Position modes): Internal function generator provides command input.</li> <li>• Software Programmed (Current, Velocity &amp; Position modes): The amplifier is controlled by software commands from either the Copley Virtual Machine (CVM) or an external source. See Copley Indexer Program User's Guide or the Copley ASCII Interface Programmer's Guide.</li> <li>• Analog Command Position (Position mode):</li> <li>• Analog Command, Profile Velocity (Position mode):</li> <li>• Digital Input (Position mode): Command input is provided via the chosen Input Source (below).</li> <li>• CAN or CANopen Over EtherCAT (CoE) (Position mode): Command input is provided over the CANopen or EtherCAT network. See the CANopen Programmer's Guide.</li> <li>• Camming (Position mode): Runs in Camming Mode. See Copley Camming User Guide.</li> <li>• Slave (Current, Velocity &amp; Position Modes). When set as a "slave", it follows the command source of the master. (Only available in Multi-axis drives.)</li> </ul>
Digital Input Source	<p>Choose the input source for PWM or Digital input commands:</p> <ul style="list-style-type: none"> <li>• Single-ended Inputs: Command input is provided via two of the amplifier's programmable digital inputs.</li> <li>• Multi-mode Port: Command input is provided via differential inputs on the amplifier's multi-mode port.</li> <li>• Differential Inputs: Command is provided via differential inputs.</li> <li>• High Speed Inputs. Command is provided via two of the amplifier's high-speed inputs.</li> </ul>

## 9. Set Miscellaneous Options.

## Setup

Setting	Description
Commutation	Commutation method: Sinusoidal, Trapezoidal, or Estimated Sinusoidal
Use back EMF for Velocity	If selected, will use the motor's measured back EMF to determine motor velocity. Recommended only for medium- to high-speed. Accuracy depends on the accuracy of the programmed Back EMF value, and may be affected by factors such as cable resistance.
Use Halls for Velocity and Position	If selected, will use transitions of the Hall switches to determine motor velocity and position. Recommended only for medium- to high-speed applications (may run roughly at low speeds).
Multi-mode Port	Selects the mode for the amplifier's multi-mode port: <ul style="list-style-type: none"> <li>▪ Buffered Primary Feedback- The multi-mode port functions as a buffered digital encoder output based on the digital encoder input.</li> <li>▪ Differential Input. The multi-mode port functions as a differential command input.</li> <li>▪ Emulated Motor Feedback- The multi-mode port functions as an emulated digital encoder output based on the motor analog encoder or motor resolver and absolute encoders.</li> </ul>

**10.** When changes are complete, click **Finish**. The changes will be saved to **Flash**.

## 6 MOTOR DATA

### 6.1 Motor Data Screen Overview

1. Click **Motor**  to open the Motor Data screen.

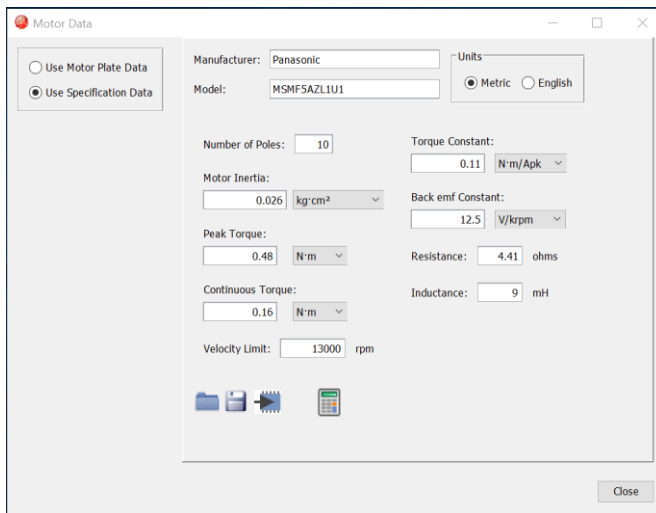

2. Choose **Use Specification Data** (See [Use Specification Data](#)).

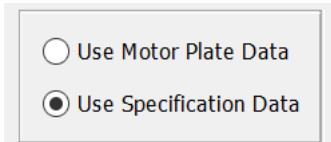



OR

Choose **Use Motor Plate Data** (See [Use Motor Plate Data](#))

3. Load data from the file  .
- OR

Enter settings manually.

4. Click  to calculate initial gains and limits. (See [Calculate](#)).
5. On the Main screen, click  -Save to flash- to avoid losing the calculated data.



## 6.2 Rotary Motor Parameters

Setting	Description
Manufacturer	Motor manufacturer's name. Saved for reference in the motor data file.
Model Number	Motor model number. Saved for reference in the motor data file.
Units	Selects whether the parameters entered in this screen are in Metric or English units.
Motor Inertia	The rotor inertia of the motor. Used for calculating initial velocity loop tuning values. Range: 0.00001 to 4,294 kg cm <sup>2</sup> . Default: 0.00001 kg-cm <sup>2</sup> .
Number of Poles	(Brushless only.) The number of magnetic poles in the motor. Required for correct commutation of the motor. If the number of poles is not known, Verify the motor's pole count using the <a href="#">Data accuracy test</a> . Range: 2 to 200. Default: 4.
Peak Torque	The peak torque that the motor can produce. Peak Torque divided by torque constant = motor's peak current limit. Range: 0.0001 to 2,100 Nm. Default: 0.0001 Nm.
Continuous Torque	The continuous torque that the motor can produce. Used with the torque constant to calculate continuous current. Range: 0.0001 to 1,000 Nm. Default: 0.0001 Nm.
Velocity Limit	Maximum speed of the motor. Used to calculate the velocity and acceleration limits for the velocity loop. Range dependent on encoder resolution.
Torque Constant	Relates the motor's input current to torque produced. Sometimes abbreviated as Kt. Range: 0.001 to 1,000 Nm/Apk. Default: 0.001 Nm/Apk.
Back emf Constant	Relates the motor's input voltage to speed. Sometimes abbreviated as Ke. Used for calculating the maximum velocity for a given amplifier bus voltage. Range: 0.01 to 21,000,000 V/Krpm. Default: 0.01 V/Krpm.
Resistance	Motor resistance line-to-line. Used for calculating the initial current loop tuning values. Range: 0.01 to 327 Ω. Default: 0.01 Ω.
Inductance	Motor inductance line-to-line. Used for calculating the initial current loop tuning values. Range: see the hardware documentation.
<b>Stepper Amplifiers Only</b>	
Rated Torque	Motor's rated operating torque. Min: .001. Max: 1000.
Rated Current	Motor's rated continuous current. Min: 0.001. Max: 1000.
Basic Step Angle	Fundamental stepper motor step, in degrees. Min: 0.225. Max: 22.5. Default 1.8.
Microsteps/Rev	Number of microsteps per revolution of the motor. Min: 4. Max: 100,000,000. Default 4000.
Full Steps/Rev	This read-only value can be used after entering Basic Step Angle to cross-check against motor data sheet.

## 6.3 Linear Motor Parameters

<b>Setting</b>	<b>Description</b>
Manufacturer	Motor maker's name. Saved in the motor data file. Choose from list or enter manually.
Model Number	Motor model number. Saved in the motor data file. Choose from list or enter manually.
Units	Selects whether the parameters entered in this screen are in Metric or English units.
Mass	The mass of the motor. Used for calculating initial velocity loop tuning values. Range: .0001 Kg to 100,000 Kg. Default: .0001 Kg.
Peak Force	The peak force that the motor can produce. Peak Force divided by Force Constant = motor's peak current limit. Range: 0.00001 to 2,000 N. Default: 0.00001 N.
Continuous Force	The continuous force that the motor can produce. Used with the force constant to calculate continuous current. Range: 0.00001 to 1,000 N. Default: 0.00001 N.
Velocity Limit	Maximum speed of the motor. Used to calculate the velocity and acceleration limits for the velocity loop. Range dependent on encoder resolution.
Force Constant	Relates the motor's input current to force produced. Sometimes abbreviated as Kf. Range: 0.00001 to 2,000 N/Amp. Default: 0.00001 N/Amp.
Back emf Constant	Relates the motor's input voltage to speed. Sometimes abbreviated as Ke. Used for calculating maximum velocity for a given amplifier voltage. Range: 0.01 to 1,000 V/M/Sec. Default: 0.01 V/M/Sec.
Resistance	Motor resistance line to line. Used for calculating the initial current loop tuning values. Range: 0.01 to 327 $\Omega$ Default: 0.01 $\Omega$
Inductance	Motor inductance line to line. Used for calculating the initial current loop tuning values. Range: see the hardware documentation.
Magnetic Pole Pair Length	The length of a pair of magnets which equals the distance moved in one electrical cycle of the motor.
<b>Stepper Amplifiers Only</b>	
Rated Force	Motor's rated operating force. Min .001 N. Max 1000 N.
Rated Current	Motor's rated continuous current. Min: 0.01 A. Max 1000 A.
Full Step	Fundamental stepper motor step distance. Min: 0.0001mm. Max: 5000 mm.
Microsteps/ Full Step	Number of microsteps per full step. Min: 1. Max: 100,000,000.

## 6.4 Feedback Notes

### 6.4.1 Encoder and Resolver Support

Some Copley Controls amplifiers are offered in multiple versions to support different types of encoder or resolver feedback. Some encoder versions support digital quadrature encoders, some support analog sin/cos encoders, and others support both. Encoder versions normally require Halls for the commutation of brushless motors. The resolver versions support standard, single and multiple speed, transmit-type resolvers.

### 6.4.2 Dual Feedback

Some Copley Controls amplifiers can receive position feedback from sensors on the motor, the load, or both, through the Primary Feedback channel, a Secondary Feedback channel (multi-mode port) or both. (Some amplifiers can also operate in certain modes without encoders or resolvers.)

A drive configured with a multi-mode port can:

- Provide a buffered digital encoder output based on the digital encoder input.
- Provide an emulated digital encoder output based on the analog encoder or resolver input.
- Provide a second digital encoder input to be used in the dual encoder position mode. In this mode, an encoder attached to the load provides position loop feedback, and the motor encoder or resolver provides velocity loop feedback.

A dual-feedback setup is shown below. The amplifier receives feedback from an incremental motor encoder through the Primary feedback channel. Position (load) encoder feedback comes through the multi-mode port. The ratio of motor turns to position encoder turns is 1 to 10.

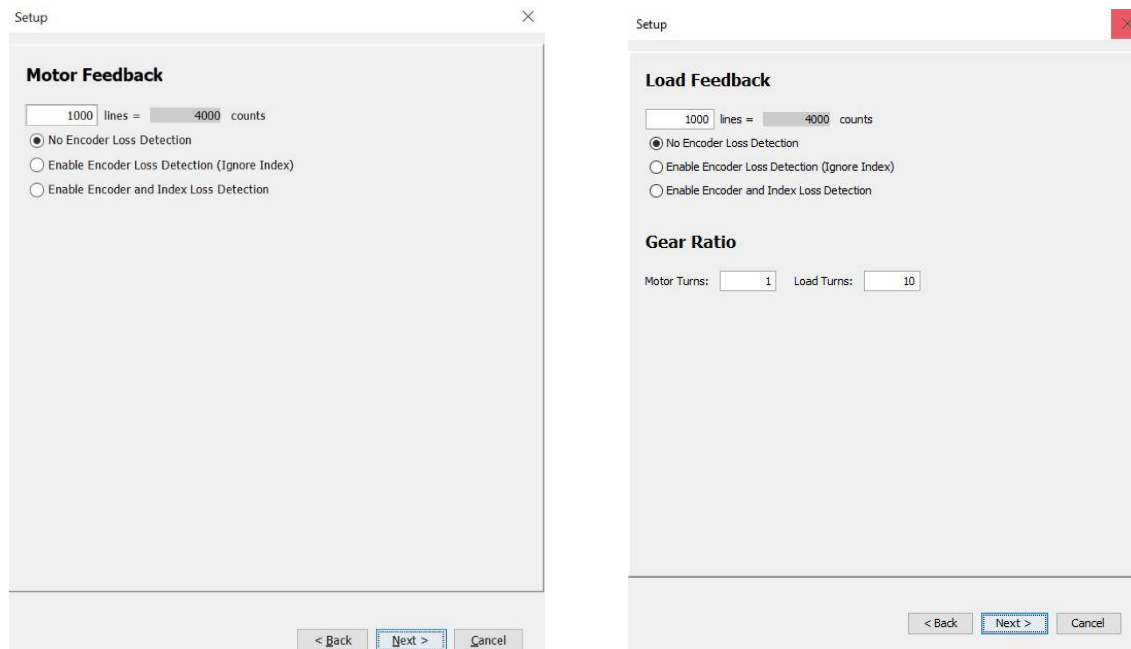

## 6.5 Calculate

The Calculate function uses the motor data to calculate initial gains and limits. These can be modified to fine-tune the amplifier. Follow the steps below:

1. Click  to calculate and display settings.

Calculated Amplifier Settings ×

Current Loop Cp Gain:	1	
Current Loop Ci Gain:	0	
Peak Current Limit	0.1	A
Continuous Current Limit	0.1	A
I <sup>2</sup> T Time Limit	1000	ms
Current Loop Offset	0	A
Current Ramp:	0	mA/s
Programmed Current:	0	A
I Loop Command Filter #1:	Disabled	
I Loop Command Filter #2:	Disabled	
Velocity Loop Vp Gain:	371	
Velocity Loop Vi Gain:	82	
Velocity Integral Drain:	0	
Velocity Loop Velocity Limit:	0.08	rpm
Velocity Loop Accel., Decel., Fast Stop:	0.03	rps <sup>2</sup>

2. Verify the peak current limit, continuous current limit, and velocity loop velocity limit. If one or more of these values seems inappropriate, click **Cancel** and check: Peak Torque (or Force), Continuous Torque (or Force), Velocity Limit, and Torque (or Force) Constant. Correct them if needed. See [Rotary Motor Parameters](#) or [Linear Motor Parameters](#).

If the Motor values are correct but the peak current limit, continuous current limit, or velocity loop velocity limit values are not optimal for the application, change these limits during the tuning process.





3. Save the values into amplifier RAM by clicking **OK**.

NOTE: When loading motor data from a file, if the motor wiring configuration in the motor file does not match the configuration currently stored in the amplifier, CME prompts for verification on which configuration to use. Select the file configuration by clicking **Yes**. The configuration will be tested as part of [Motor Phasing](#).

4. On the Main screen, click  to avoid losing the calculated data by saving to flash.

## 6.6 Use Specification Data

Fill in the requested fields with information from the datasheet of the motor you are trying to control.

Action	Name	Description
	Save motor data	Saves motor/feedback/brake settings from PC to a file with .ccm name extension.
	Restore motor data	Restores contents of a .ccm file to PC.
	Save motor data to flash	Saves motor/feedback/brake settings from PC to amplifier permanent flash memory.
	Calculate	Calculates initial tuning and limit values.
Feedback Button	Feedback	View the Feedback settings

## 6.7 Use Motor Plate Data

1. Choose **Use Motor Plate Data**.

2. Enter **Rated Speed**.
3. Enter **Rated Current**.
4. Enter **Rated Torque** or **Power** from the motor label.

Note: The Rated Torque will be defaulted to a minimum value. It should not be 0. It will be calculated if motor Power is entered.

Parameter	Description
Rated Speed	Speed of the motor at which it produces its rated (maximum) power, when the specified (rated) voltage is given at its rated Load.
Rated Current	Maximum safe continuous current of the motor
Rated Torque	Maximum safe continuous torque of the motor
Power	Continuous safe motor power

5. Click **Characterize and Tune** and follow the instructions in [Characterize and Tune](#).

### 6.7.1 Characterize and Tune

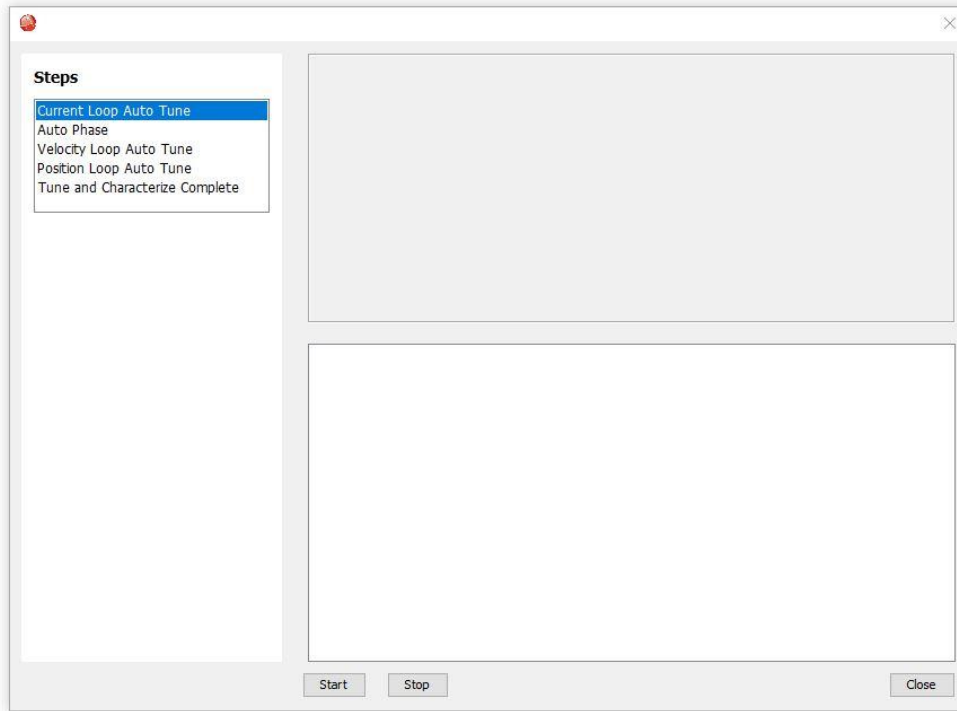

1. Click **Start** to start the **Current Loop Auto tune**.

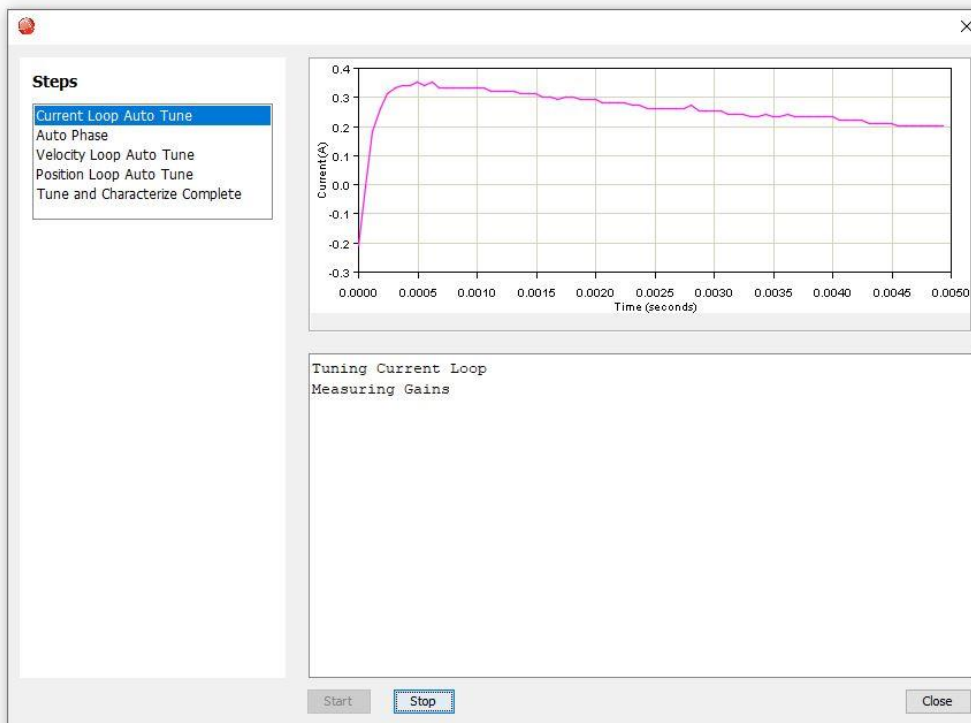

## Motor Data

- When the current loop auto tune is complete, it goes to **Auto Phase**.

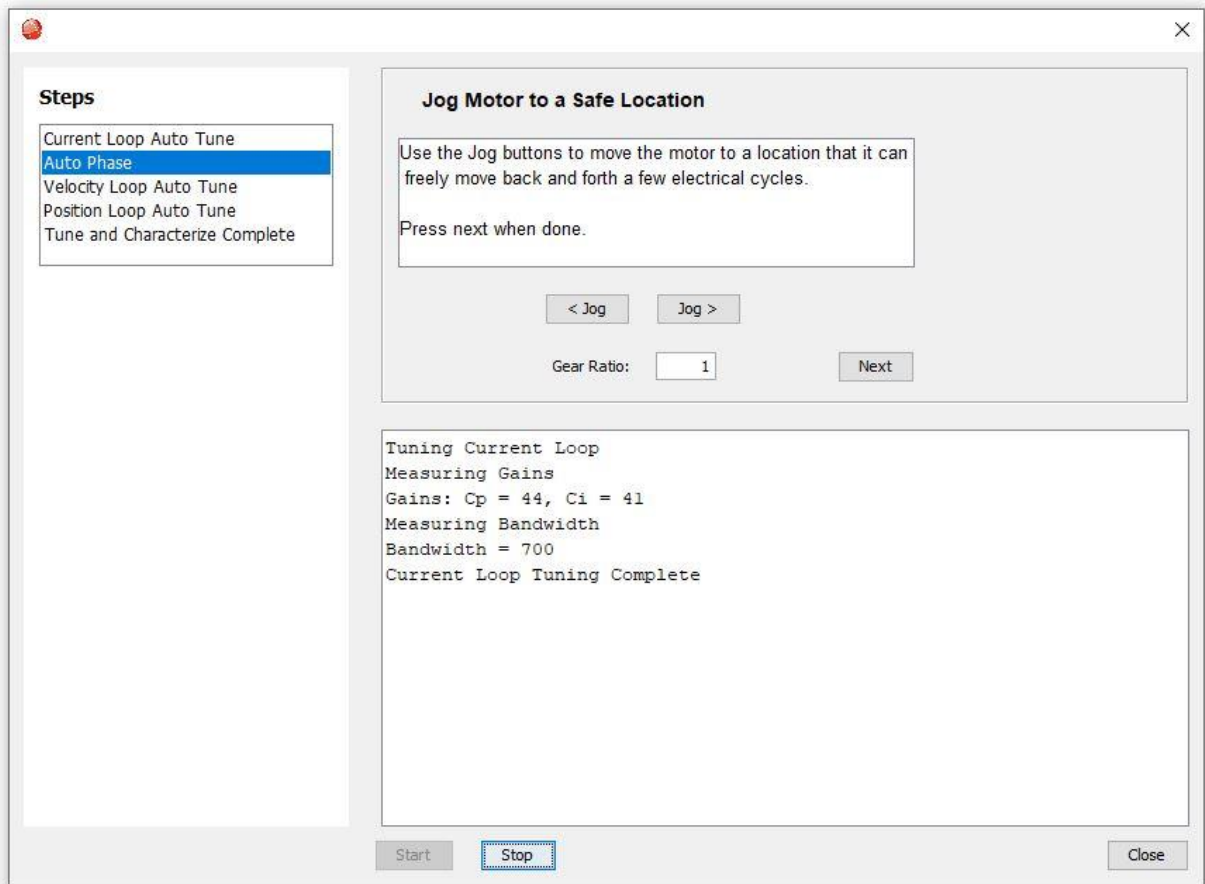

- Press **<Jog or Jog>** depending on which direction you want the motor rotating.
- Click **Next** and answer the question(s) that pop up.





# Motor Data

The screenshot shows a software window titled "Motor Data" with a close button (X) in the top right corner. On the left, a "Steps" list includes: "Current Loop Auto Tune", "Auto Phase" (highlighted in blue), "Velocity Loop Auto Tune", "Position Loop Auto Tune", and "Tune and Characterize Complete". The main area features a "Commanded Motor Phase Angle" gauge with a needle pointing to approximately 180 degrees. Below the gauge, it displays "Actual Motor Position: -3324 counts". A text area contains the following log entries: "Tuning Current Loop", "Measuring Gains", "Gains: Cp = 44, Ci = 41", "Measuring Bandwidth", "Bandwidth = 700", "Current Loop Tuning Complete", "Starting Motor Wiring Test", "Configuring initial settings", and "Microstepping". At the bottom, there are "Start", "Stop", and "Close" buttons.

A dialog box titled "Positive Reference" with a close button (X) in the top right corner. It contains an information icon (i) and the text "Observe motor motion to verify positive direction." Below the text is an "OK" button.

A dialog box titled "Motor Wiring" with a close button (X) in the top right corner. It contains a question mark icon (?) and the text "Did the motor move in the direction you consider positive?". Below the text are three buttons: "Yes", "No", and "Cancel".

## Motor Data

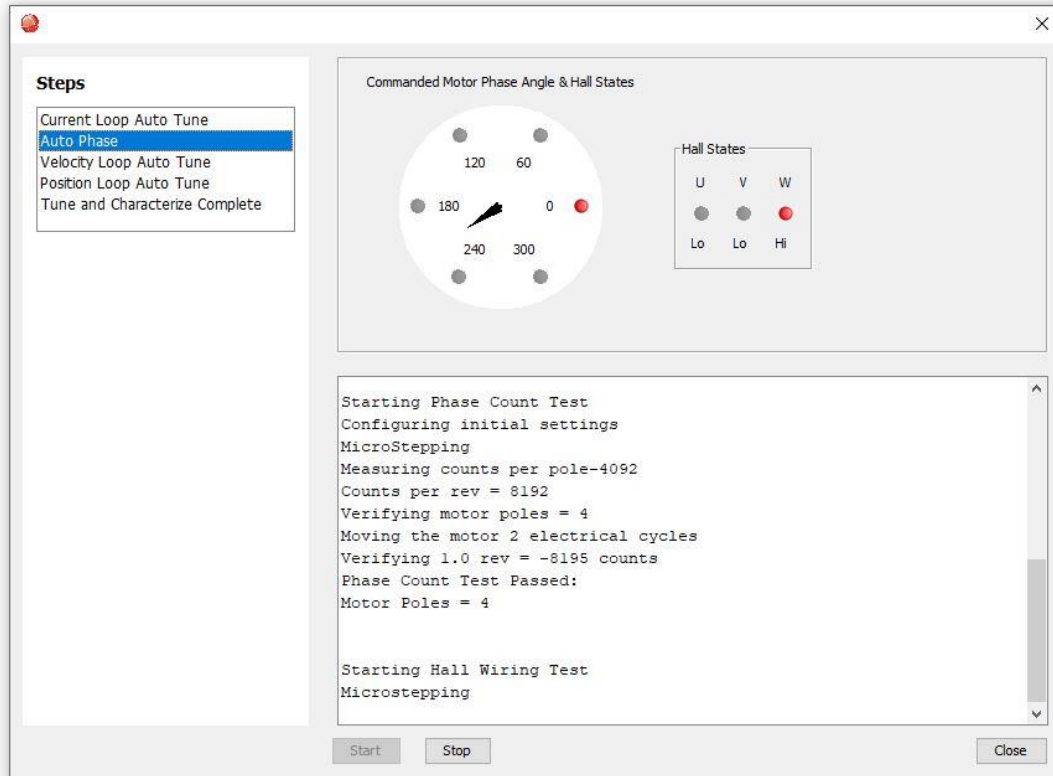

5. When the auto phase is complete, it goes to **Velocity Loop Auto Tune**.

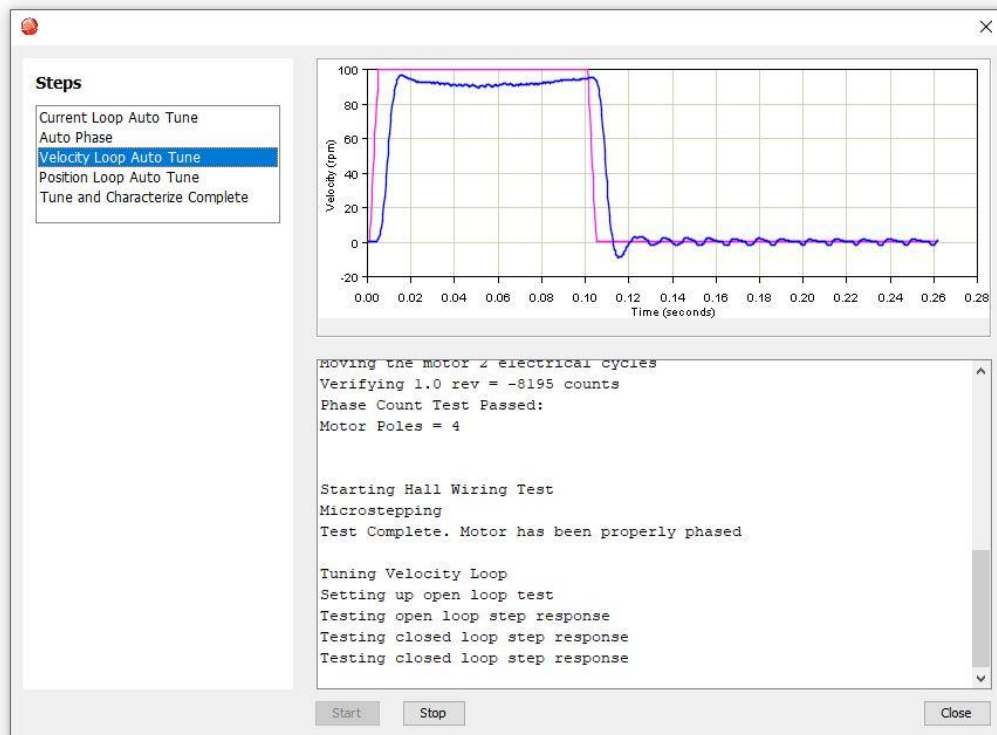

## Motor Data

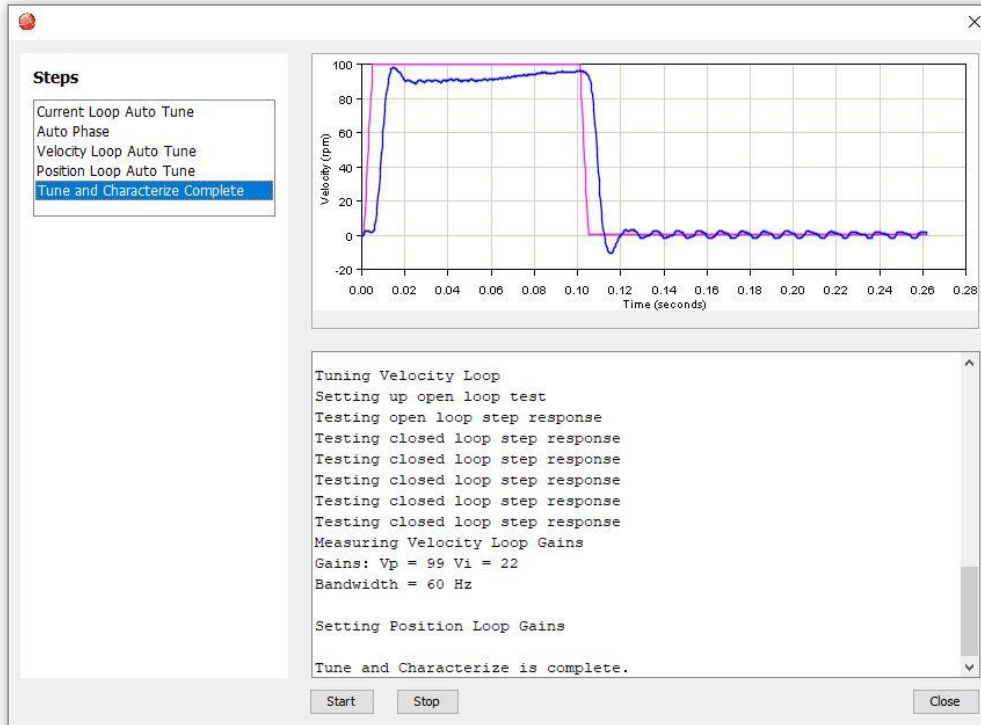

**Note:** You can start your tuning from any of the steps, provided all the other steps above it have been completed at some point in the past.

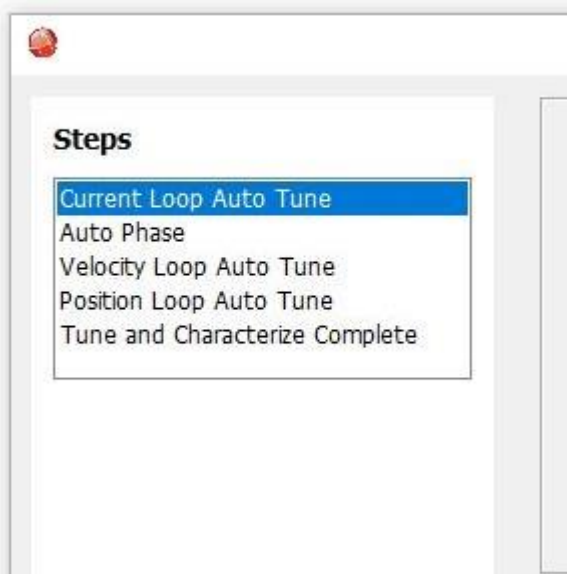

# 7 DIGITAL INPUTS AND OUTPUTS

## 7.1 Digital Inputs

Click Input/Output  on the Main screen. A typical screen is shown below. Options vary with model and configuration.

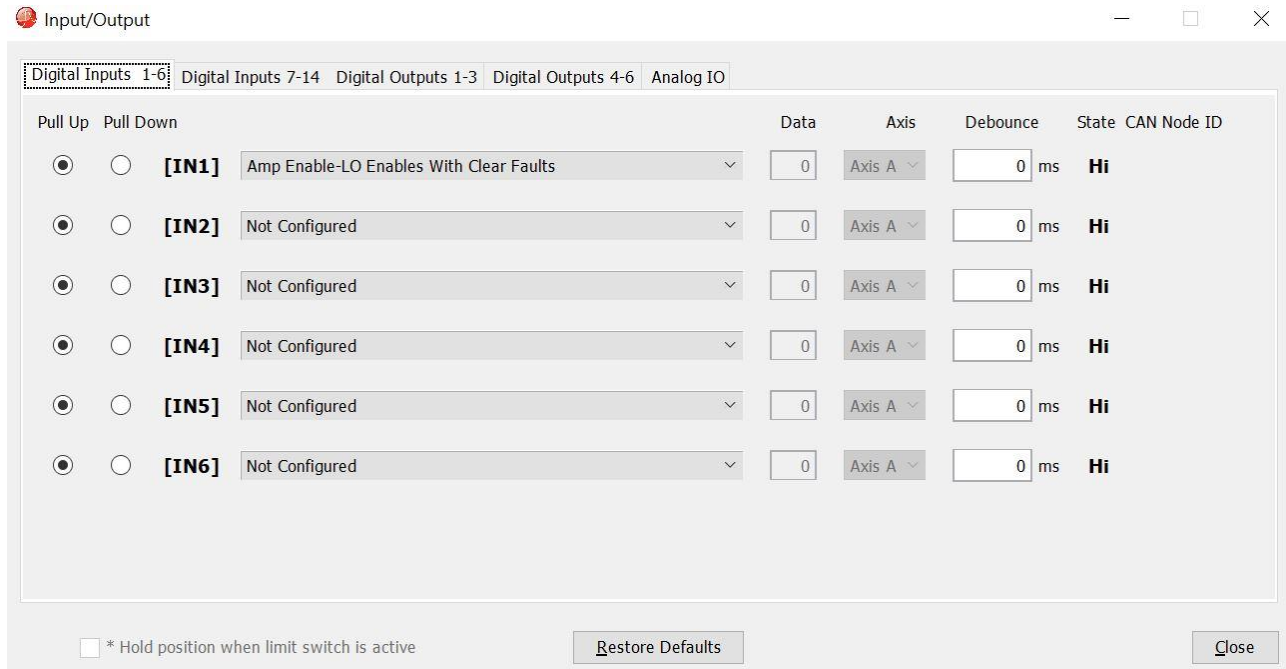

Parameter	Description
Pull up +5 V	Pulls up the group of inputs up to internal +5 V.
Pull down	Pulls the group of inputs down to internal signal ground.
Debounce Time	Specifies how long an input must remain stable at a new state before the amplifier recognizes the state. Increase to prevent multiple triggering caused by switch bounce upon switch closures. Range: 0 to 10,000 mS. Debounce does not affect inputs that have been configured as PWM, Pulse and Direction, or Quadrature control inputs.
IN#	Select the function for the input.
Axis	This option is only available for multi axis drives.
*Hold position when limit switch is active	<b>Available in position mode only:</b> When one or more inputs are configured as a limit switch (NEG Limit-HI Inhibits, NEG Limit-LO Inhibits, POS Limit-HI Inhibits, or POS Limit-LO Inhibits). The *Hold position option prevents any motion while a limit switch is active. This option uses the Abort Deceleration rate to stop the motor as described in <a href="#">Trajectory Limits</a> .  <b>CAUTION: If the amplifier is switched back to current or velocity mode with this option selected, the limit switches will no longer function</b>
Restore Defaults	Restores all inputs and outputs to factory defaults.

## Digital Inputs and Outputs

### 7.1.1 Digital Input Functions

Depending on the mode of operation, some inputs may have a predefined function such as enable or motor temperature sensor. Typically, IN1 is defined as an enable input.

Input Function	Description
AMP Enable-LO Enables with clear faults	A low input will enable the amplifier. Any transition will clear latched faults and outputs.
AMP Enable-HI Enables with clear faults	A high input will enable the amplifier. Any transition will clear latched faults and outputs.
AMP Enable-LO Enables with reset	A low input will enable the amplifier. A low to High transition will reset the amplifier.
AMP Enable-HI Enables with reset	A high input will enable the amplifier. A high to low transition will reset the amplifier.
AMP Enable-LO Enables	A low input will enable the amplifier.
AMP Enable-HI Enables	A high input will enable the amplifier.
Not Configured	No function assigned to the input.
POS Limit-HI Inhibits*	A high input will inhibit motion in positive direction.
POS Limit-LO Inhibits*	A low input will inhibit motion in positive direction.
NEG Limit-HI Inhibits*	A high input will inhibit motion in negative direction.
NEG Limit-LO Inhibits*	A low input will inhibit motion in negative direction.
Reset on LO-HI Transition	A low to high transition of the input will reset the amplifier.
Reset on HI-LO Transition	A high to low transition of the input will reset the amplifier.
Motor Temp HI Disables	A high input will generate a Motor Over Temperature fault.
Motor Temp LO Disables	A low input will generate a Motor Over Temperature fault.
Home Switch Active HI	A high input indicates the home switch is activated.
Home Switch Active LO	A low input indicates the home switch is activated.
Motion Abort Active HI	A high input causes the amplifier to stop motion, using the Abort Deceleration rate described in <a href="#">Trajectory Limits</a> . The amplifier remains enabled.
Motion Abort Active LO	A low input causes the amplifier to stop motion, using the Abort Deceleration rate described in <a href="#">Trajectory Limits</a> . The amplifier remains enabled.
High Res Analog Divide Active HI	A high input causes the firmware to divide the level of the analog input signal by 8.
High Res Analog Divide Active LO	A low input causes the firmware to divide the level of the analog input signal by 8.
Simulated Absolute Encoder Burst on LO-HI Transition	Disable simulated encoder output when low. Burst current position on encoder output on rising edge.
Simulated Absolute Encoder Burst on HI-LO Transition	Disable simulated encoder output when high. Burst current position on encoder output on falling edge.
Clear Faults and Event Latch on LO-HI Transition	Clear faults & event latch on rising edge.
Clear Faults and Event Latch on HI-LO Transition	Clear faults & event latch on falling edge.

## Digital Inputs and Outputs

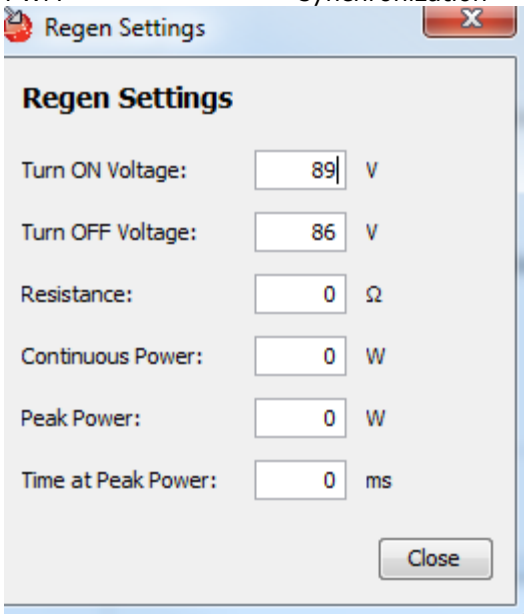
Abort Move on LO-HI if >N Counts From Dest in Reg	Abort move on rising edge if further then N counts from destination position. Number of counts (N) is stored in an index register identified by bits 8-11.
Abort Move on HI-LO if >N Counts From Dest in Reg	Abort move on falling edge if further then N counts from destination position. Number of counts (N) is stored in an index register identified by bits 8-11.
Encoder Fault- Active HI	Encoder fault input, active high
Encoder Fault- Active LO	Encoder fault input, active low
Trajectory Update on LO-HI Transition	On the low to high transition of this input, the trajectory generator will generate a previously configured trajectory.
Trajectory Update on HI-LO transition	On the high to low transition of this input, the trajectory generator will generate a previously configured trajectory.
Count Rising Edges, Save To Reg	Count rising edges of input to indexer register (Register number identified by bits 8-11).
Count Falling Edges, Save To Reg	Count falling edges of input to indexer register (Register number identified by bits 8-11).
Amp Disable-HI with AC Removed	For a controlled stop, the AC power is cut, and the amplifier is disabled with a high input.
Amp Disable-LO with AC Removed	For a controlled stop, the AC power is cut, and the amplifier is disabled with a low input.
High Speed Position Capture on LO-HI Transition	High Speed Position Capture on LO-HI Transition
High Speed Position Capture on HI-LO Transition	High Speed Position Capture on HI-LO Transition
PWM Sync Input	<p>PWM synchronization input.</p>  <p><a href="#">Synchronizing PWM Switching Frequency.</a> (For high-speed inputs only.)</p>

## 7.2 Digital Outputs

A typical Digital Outputs screen is shown below.

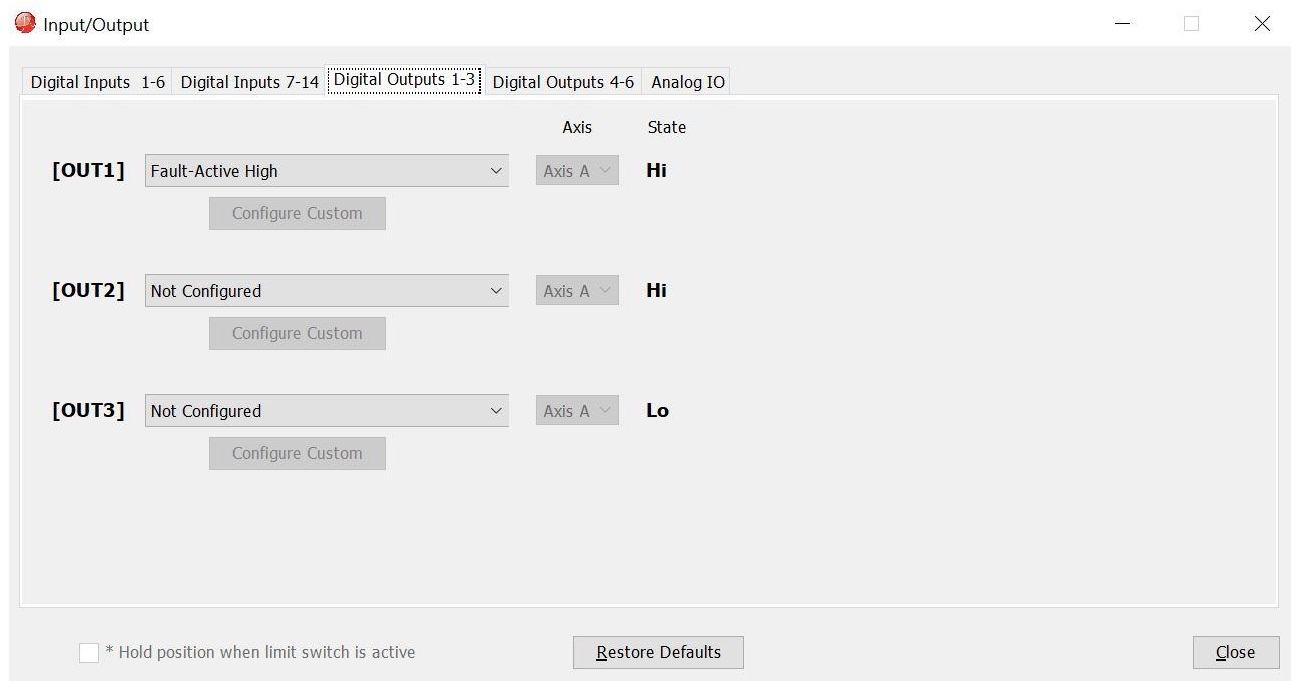

**Note:** Options vary with models and configurations.

### 7.2.1 Digital Output Functions

Output Function	Description
Not Configured	No function. Output remains Hi/Off.

## Digital Inputs and Outputs

Fault Active High	Output goes Hi/Off when one or more faults are detected.
Fault-Active Low	Output goes Lo/On when one or more faults are detected.
Brake-Active High	(Brake hold) Output goes Hi/Off to activate the brake.
Brake-Active Low	(Brake release) Output goes Lo/On to activate the brake.
PWM Sync Output	The PWM synchronization output.
Custom Event	See <a href="#">Custom Triggered Event Output</a>
Custom Trajectory Status	See <a href="#">Custom Trajectory Status Triggered Output</a> .
Custom Position Triggered Output	See <a href="#">Custom Position Triggered Output</a> .
Program Control Active High	Output state controlled by CVM or external program.
Program Control Active Low	Output state controlled by CVM or external program
External Regen Active High	See <a href="#">Output Regen Settings</a>
External Regen Active Low	See <a href="#">Output Regen Settings</a>

### 7.2.2 ID Switch and Network LED SLI

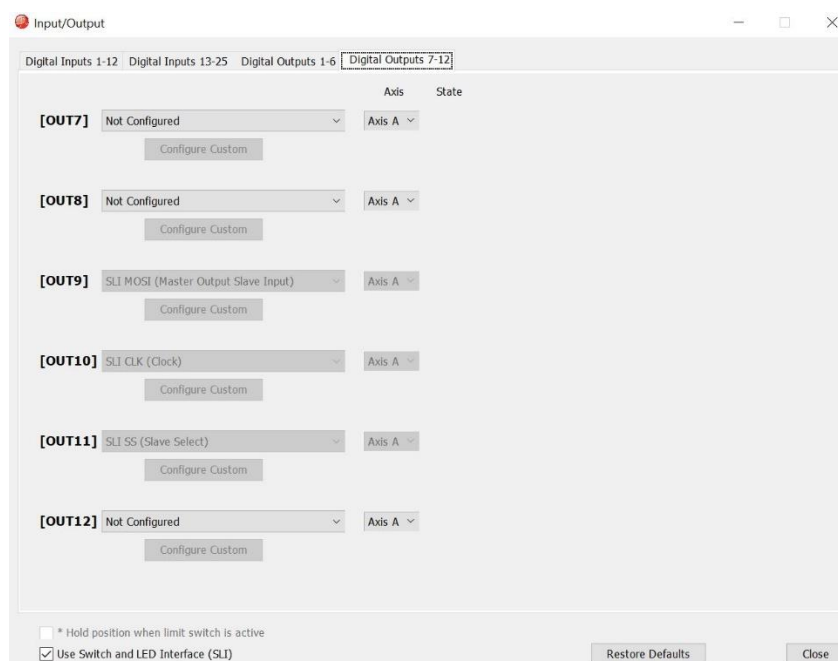

Uncheck the box to disable Network ID switch and LED to get additional I/O (3 outputs, 1 input).

## 7.3 Custom Event Triggered Output

Digital outputs can be configured for one or more bits in the Event Status (faults, warnings, and status).



## Digital Inputs and Outputs

1. Choose **Custom Event** for the output configuration, then click **Configure Custom** to open the Event Triggered Output screen.

2. Select one or more events from the list. Selections are OR'ed together, so that any event will cause the output to go active. The **Clear** button clears all selections.
3. Choose Output Active High/Off or Output Active Low/On.
4. To latch the output, set the Latch Output option.

**Latching an output does not eliminate the risk of unexpected motion with non-latched faults.**



**DANGER**

Associating a fault with a latched, custom-configured output does not latch the fault itself. After the cause of a non-latched fault is corrected, the amplifier re-enables without operator intervention. In this case, motion may restart unexpectedly.

**Failure to heed this warning can cause equipment damage, injury, or death.**

5. Click **OK** to save changes to amplifier RAM and close the screen.

<b>Event</b>	<b>Description</b>
Amplifier Fault	A latched fault is active.
Amp Over Temperature	For descriptions of these fault events, see <a href="#">Fault Descriptions</a> .
Motor Phasing Error	
Feedback Error	
Motor Over Temp	
Under Voltage	
Over Voltage	

## Digital Inputs and Outputs

Short Circuit	
Current Limited	The current output is being limited by the I2T Algorithm or a latched current fault has occurred.
Voltage Limited	Current loop is commanding the full bus voltage to control current. Commonly occurs when the motor is running as fast as the available bus voltage will allow.
Positive Limit Switch	Axis has contacted positive limit switch.
Negative Limit Switch	Axis has contacted negative limit switch.
Amp Disabled by Hardware	Amplifier enable input(s) is not active.
Amp Disabled by Software	Amplifier is disabled by a software command.
Attempting to Stop Motor	The amplifier, while in velocity or position mode, has been disabled. In velocity mode, amplifier is using the Fast Stop Ramp described in <a href="#">Velocity Loop Limits</a> . In position mode, the amplifier is using the Abort Deceleration rate described in <a href="#">Trajectory Limits</a> . The output remains active until the amplifier is re-enabled.
Motor Brake Active	Motor brake activated.
PWM Outputs Disabled	The amplifier's PWM outputs are disabled.
Positive Software Limit	Actual position has exceeded the positive software limit setting. See <a href="#">Homing</a> .
Negative Software Limit	Actual position has exceeded the negative software limit setting. See <a href="#">Homing</a>
Following Error	Following error has reached programmed fault limit. See <a href="#">Following Error Faults</a>
Following Warning	Following error has reached programmed warning limit. See <a href="#">Following Error Faults</a>
Position has Wrapped	The position counters have exceeded the maximum range of $-2^{31} - 2^{31}-1$ and have wrapped. Normal amplifier operation is not affected.
Velocity Limited	The velocity command (from analog input, PWM input, or position loop) has exceeded the velocity limit. See <a href="#">Velocity Loop Limits</a> .
Acceleration Limited	In velocity mode, motor has reached an acceleration or deceleration limit that was set as described in <a href="#">Velocity Loop Limits</a> .
Pos Outside of Tracking Window	The following error has exceeded the programmed value. See <a href="#">Position and Velocity Tracking Windows</a>
Home Switch Active	Axis has contacted the home limit switch.
In Motion	The motor is moving, or it has not yet settled after a move. The amplifier is settled when it comes within the position tracking window and stays there for the tracking time at the end of a move. Once this bit is set, it remains set until a new move is started.
Vel Outside of Tracking Window	Difference between target and actual velocity has exceeded the window. See <a href="#">Position and Velocity Tracking Windows</a> .
Phase not Initialized	Amplifier is using Phase Initialization function and phase is not initialized.
Command Input Fault	PWM or other command signal (e.g., EtherCAT master) not present. If Allow 100% Output option is enabled by a setting Bit 3 of Digital Input Command Configuration this fault will not detect a missing PWM command.

### 7.3.1 Latched vs. Non-Latched Custom Event

An output that is configured for a custom event can be latched or non-latched.

If a non-latched output goes active, it will go inactive as soon as the last of the selected events is cleared. If a latched output goes active, it remains active until at least one of the following actions has been taken:

- Reset or power-cycle the amplifier.

## Digital Inputs and Outputs

- Cycle (disable and then enable) an input that is configured as Enable with Clear Faults or Enable with Reset.
- Open the Control Panel and press Clear Faults or Reset.

The latched/non-latched behavior of an output configured as a custom event is independent of the drive’s latched/non-latched fault. Consider the following example:

OUT3 is configured as a custom event: under voltage and latched, but the Under Voltage fault on the Configure Faults screen is set to non-latched. The table below shows the difference in behavior between the output and the drive’s fault.

Condition	Drive	OUT3
Under voltage condition occurs	Disables PWM outputs, and reports under voltage faults	Goes to active state
Under voltage condition is corrected	Under voltage fault is not reported and PWM outputs are enabled	Stays active

## 7.4 Custom Trajectory Status Triggered Output

Digital outputs can be configured for one or more events in the Trajectory Status.

1. Choose **Custom Trajectory Status** for an output and then click **Configure Custom** to open the Trajectory Status Triggered Output screen.

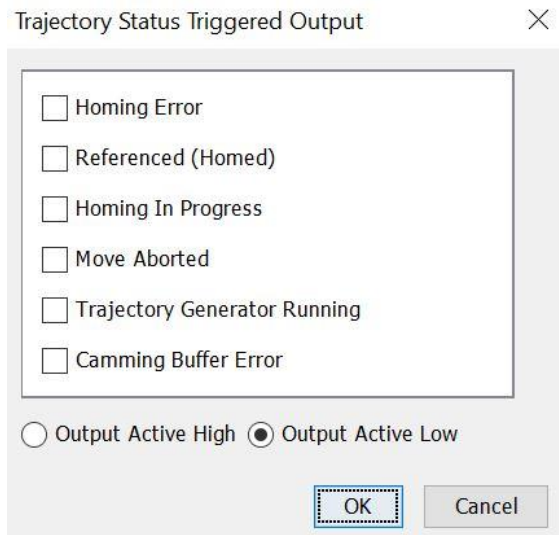
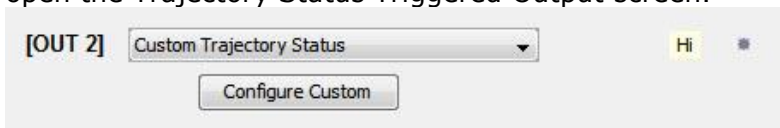

2. Select one or more events from the list. Selections are OR’ed together, so that any event will cause the output to go active.

Status	Description
Homing Error	Activate output if an error occurred in the last homing attempt
Referenced (Homed)	Activate output if the most recent homing attempt was successful
Homing in Progress	Activate output when a homing move is in progress
Move Aborted	Activate output if move is aborted

## Digital Inputs and Outputs

Trajectory Generator Running	Activate output while trajectory generator is generating a move
Camming Buffer Error	A camming buffer error has occurred

3. Choose Output Active High to have the output go high when active or Output Active Low to have the output go low when active.
4. Click **OK** to save changes to amplifier RAM and close the screen.

## 7.5 Custom Position Triggered Output

1. Choose **Custom Position Triggered Output** for an output and then click **Configure Custom** to open the In Position Triggered Output screen.

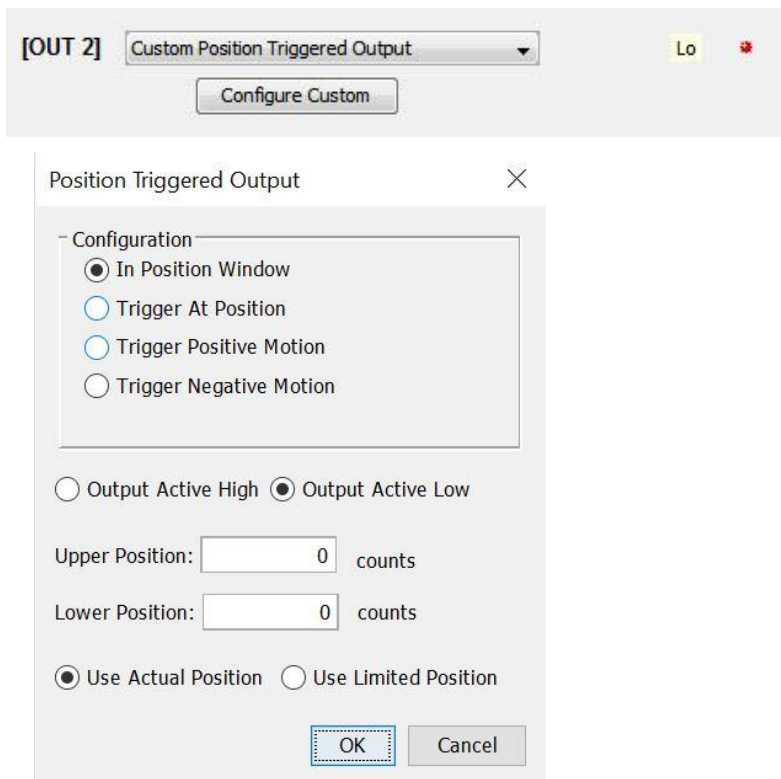

2. Select one of the configurations described below and enter appropriate values for the parameters.

Configuration	Description and Parameters
In Position Window	Activates the output while the axis is in the window between the programmed <b>Upper</b> and <b>Lower</b> positions.
Trigger at Position	Activates the output for the programmed <b>Time</b> when the axis travels through the programmed <b>Position</b> .
Trigger Positive Motion	Activates the output for the programmed <b>Time</b> when the axis travels in the positive direction through the programmed <b>Position</b> .
Trigger Negative Motion	Activates the output for the programmed <b>Time</b> when the axis travels in the negative direction through the programmed <b>Position</b> .

3. Choose Output Active High to have the output go high when active or Output Active Low to have the output go low when active.

## Digital Inputs and Outputs

4. In stepper mode with no encoder, choose **Use Limited Position**. Otherwise choose **Use Actual Position**.
5. Click **OK** to save changes to amplifier RAM and close the Custom Output Configuration screen.

## 7.6 Output Regen settings

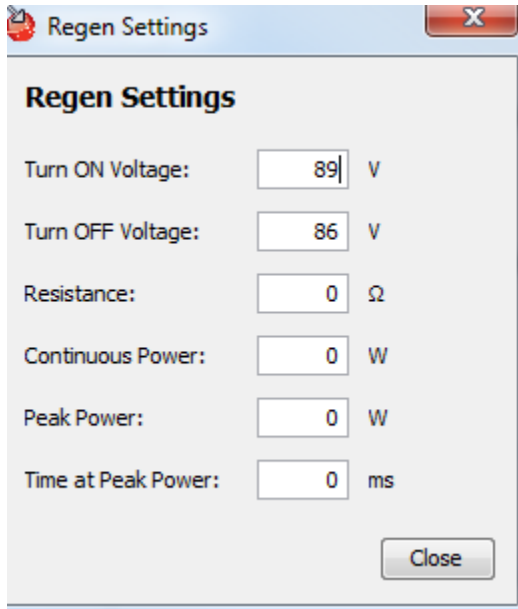

## 7.7 Synchronizing PWM Switching Frequency

In some situations, such as when sampling small analog signals, it is desirable to synchronize the PWM switching frequency among multiple amplifiers. In these cases, one amplifier serves as a master for one or more slave amplifiers. The PWM sync output of the master sends a signal that is received as a PWM sync input by each slave. To configure this, an output of the master must be configured as PWM Sync Output and one input on each of the slaves must be configured as PWM Sync Input.

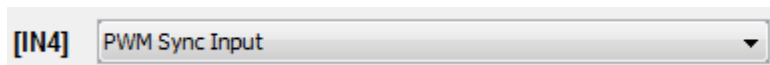
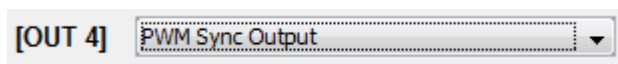

## 7.8 Analog I/O

A typical Analog I/O screen is shown below.

Note: Only products with an analog output will have this option.

## Digital Inputs and Outputs



### 7.8.1 Analog Motor Temperature Sensor

Enter a voltage limit in mV. Fault will occur when voltage is above limit for positive values. For fault set below limit enter the limits value as a negative value. Actual voltage is the sensor reading in mV.

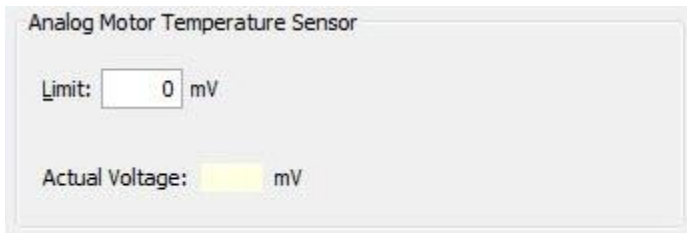

### 7.8.2 Analog Output

The Analog Output has three modes of operation - Manual, Actual Current and Actual Velocity. When Manual is chosen, the output is set to the programmed value, +/- 5V, entered in mV.

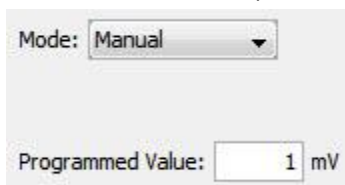

When Actual Current is chosen, the output value is proportional to the actual motor current.

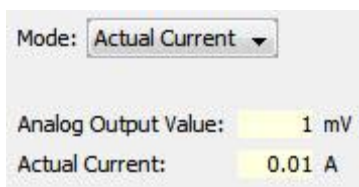

When Actual Velocity is chosen, the output value is proportional to the actual motor velocity.

## Digital Inputs and Outputs

Mode:  ▾

Analog Output Value:  mV

Actual Velocity:  rpm

## 8 COMMAND INPUTS

### 8.1 Analog Command Settings

Click the Analog Command button  on the Main screen.

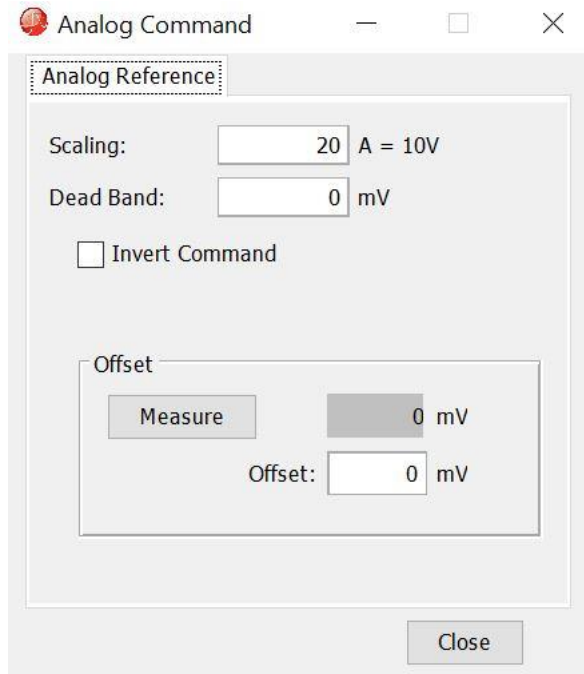

Analog Reference Parameter	Description
Scaling	<p><b>Current mode:</b> output current produced by +10 Vdc of input. Range: 0 to 10,000,000 A. Default: Peak Current value.</p> <p><b>Velocity mode:</b> output velocity produced by +10 Vdc of input. Range: 0 to 100,000 rpm (mm/sec). Default: Maximum Velocity value.</p> <p><b>Position mode:</b> position change (counts or mm) produced by +10 Vdc of input. Range: 0 to 1,000,000,000 counts. Default: 1 Revolution of a rotary motor or 1 pole pair distance for a linear motor. For more information, see <a href="#">Scaling</a></p>
Dead Band	Sets dead band. Range: -10,000 to 10,000 mV. Default: 0. For more information, see <a href="#">Dead Band</a>
Invert Command	Inverts polarity of amplifier output with respect to input signal.
Offset	(Current and Velocity modes only.) Used to offset input voltage error in an open loop system. Not recommended for use when the amplifier is part of a closed loop system. Range: -10,000 to 10,000 mV. Default: 0. For more information, see <a href="#">Offset</a>



## Command Inputs

### 8.1.1 Analog Command Notes

The amplifier can be driven by an analog voltage signal through the analog command input. The amplifier converts the signal to a current, velocity, or position command as appropriate for current, velocity, or position mode operation, respectively. The analog input signal is conditioned by the scaling, dead band, and offset settings.

### 8.1.2 Scaling

The magnitude of the command generated by an input signal is proportional to the input signal voltage. Scaling controls the input-to-command ratio, allowing the use of an optimal command range for any given input voltage signal range.

For example, in current mode, with default scaling, +10 Vdc of input generates a command equal to the amplifier's peak current output; +5 Vdc equals half of that.

Scaling could also be useful if, for example, the signal source generates a signal range between 0 and +10 Vdc, but the command range only requires +7.5 Vdc of input. In this case, scaling allows the amplifier to equate +7.5 Vdc with the amplifier's peak current (in current mode) or maximum velocity (in velocity mode), increasing the resolution of control.

### 8.1.3 Dead Band

To protect against unintended response to low-level line noise or interference, the amplifier can be programmed with a "dead band" to condition the response to the input signal voltage. The amplifier treats anything within the dead band ranges as zero and subtracts the dead band value from all other values. For instance, with a dead band of 100 mV, the amplifier ignores signals between -100 mV and +100 mV, and treats 101 mV as 1 mV, 200 mV as 100 mV, and so on.

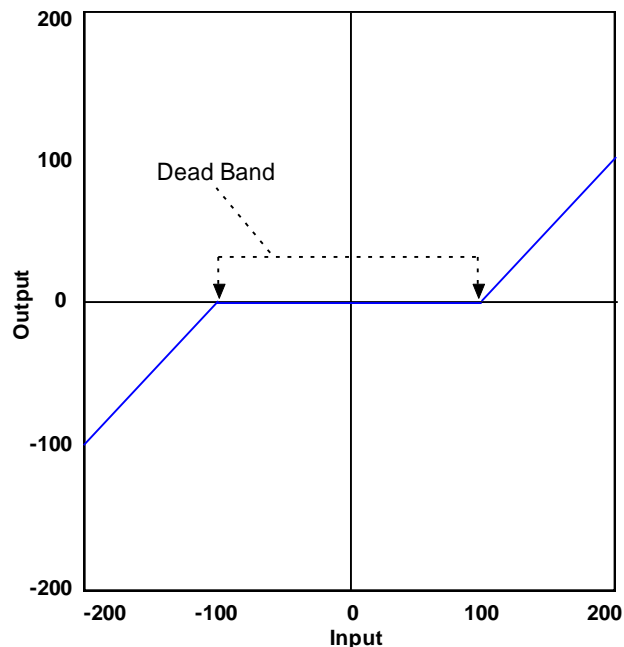

### 8.1.4 Offset

To remove the effects of voltage offsets between the controller and the amplifier in open loop systems, CME provides an Offset parameter and a Measure function. The Measure function takes 10 readings of the analog input voltage over a period of approximately 200 ms, averages the readings, and then displays the results. The Offset parameter allows the user to enter a corrective offset to be applied to the input voltage.

The offset can also set up the amplifier for bi-directional operation from a uni-polar input voltage. An example of this would be a 0 to +10 Vdc velocity command that had to control 1000 rpm

## Command Inputs

CCW to 1000 rpm CW. Scale would be set to 2000 rpm for a +10 Vdc input and Offset set to -5V. After this, a 0 Vdc input command would be interpreted as -5 Vdc, which would produce 1000 rpm CCW rotation. A +10 Vdc command would be interpreted as +5 Vdc and produce 1000 rpm CW rotation.

### 8.1.5 Monitoring the Analog Command Voltage

The analog input voltage can be monitored in the Control Panel and in the Scope Tool. The voltage displayed in both cases is after both offset and deadband have been applied.

### 8.1.6 Analog Command in Position Mode

The Analog Position command operates as a relative motion command. When the amplifier is enabled the voltage on the analog input is read. Then any change in the command voltage will move the axis a relative distance, equal to the change in voltage, from its position when enabled. To use the analog position command as an absolute position command, the amplifier should be homed every time it is enabled. The Homing sequence may be initiated by CAN, ASCII serial, or CVM Indexer program commands.

## 8.2 PWM Input Settings

Click the PWM Command button  on the Main screen.

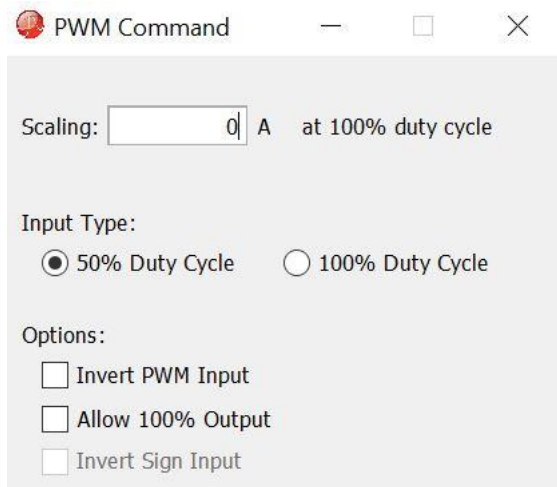

Parameter	Description
Scaling	<b>Current mode:</b> output current at 100% duty cycle. Range: 0 to 10,000,000 A. Default: Peak Current value. <b>Velocity mode:</b> output velocity at 100% duty cycle. Range: 0 to 100,000 rpm (mm/sec). Default: Maximum Velocity value.
PWM Input Type	One wire 50% or two wire 100% with direction.
Options	<b>Invert PWM input:</b> Inverts the PWM logic. <b>Allow 100% output:</b> Overrides the 100% command safety measure. See <a href="#">Failsafe Protection from 0 or 100% Duty Cycle Commands</a> <b>Invert Sign Input:</b> In 100% duty cycle mode, inverts the polarity of the directional input.

**8.2.1 50% Duty Cycle (One-Wire)**

The input takes a PWM waveform of fixed frequency and variable duty cycle. As shown below, a 50% duty cycle produces zero output from the amplifier. Increasing the duty cycle toward 100% commands a positive output and decreasing the duty cycle toward zero commands a negative output.

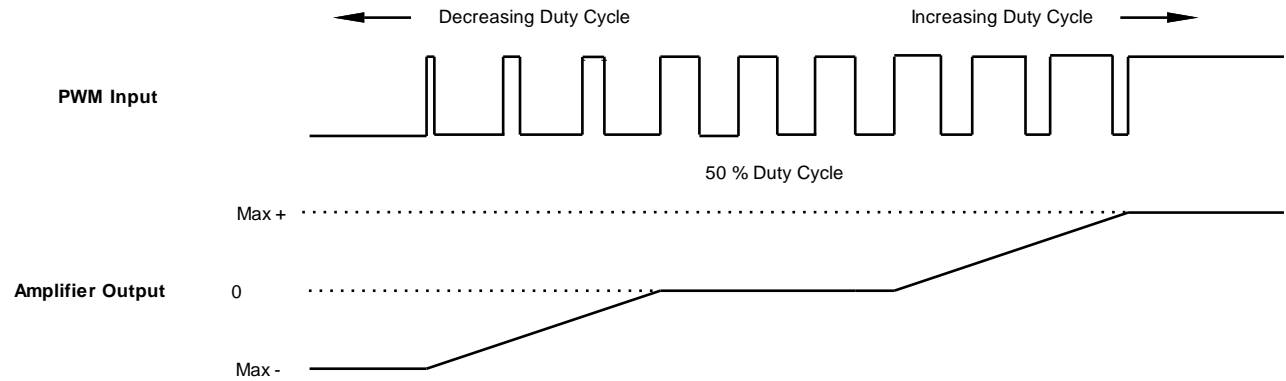

The command can be inverted so that increased duty cycle commands negative output and vice versa.

**8.2.2 100% Duty Cycle (Two-Wire)**

One input takes a PWM waveform of fixed frequency and variable duty cycle, and the other input takes a DC level that controls the polarity of the output. A 0% duty cycle creates a zero command, and a 100% duty cycle creates a maximum command level. The command can be inverted so that increasing the duty cycle decreases the output and vice versa.

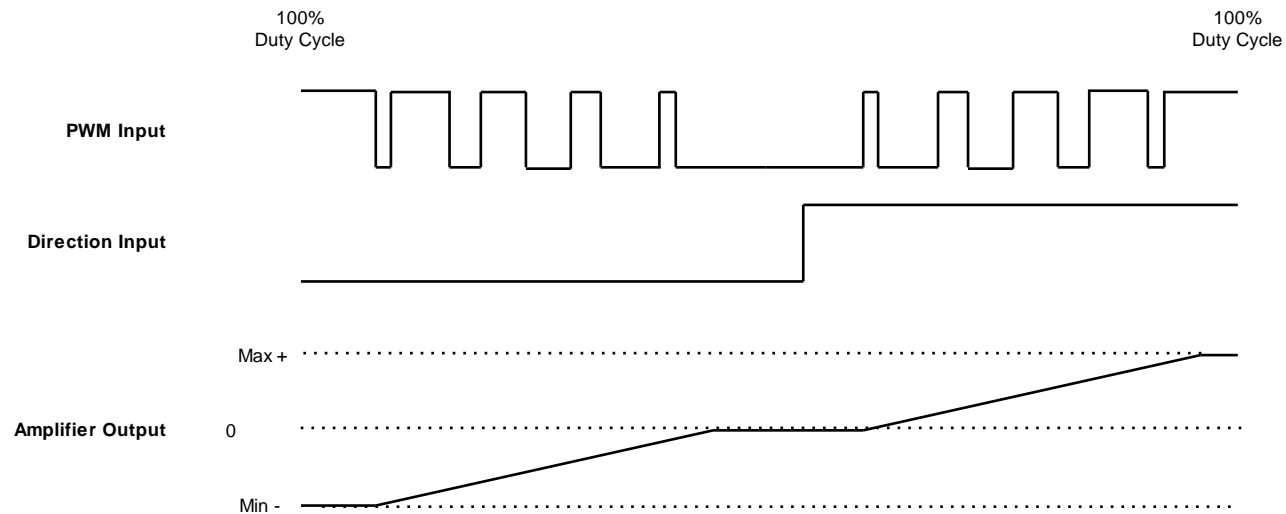

**8.2.3 Failsafe Protection from 0 or 100% Duty Cycle Commands**

In both formats, the amplifier can be programmed to interpret 0 or 100% duty cycle as a zero command, providing a measure of safety in case of controller failure or cable break.

## 8.3 Digital Position Input Settings

Click the Digital Input button  on the Main Screen.

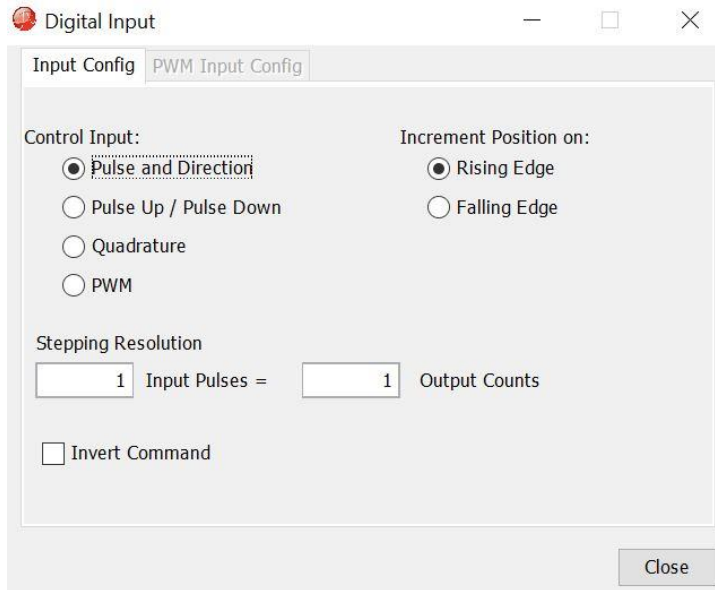

Parameter	Description
Control Input	<p><b>Pulse and Direction:</b> One input takes a series of pulses as motion step commands, and another input takes a high or low signal as a direction command.</p> <p><b>Pulse Up / Pulse Down:</b> One input takes each pulse as a positive step command, and another takes each pulse as a negative step command.</p> <p><b>Quadrature:</b> A/B quadrature commands from a master encoder (via two inputs) provide velocity and direction commands.</p> <p><b>PWM:</b> The input takes a fixed frequency with variable pulse width.</p>
Increment position on	<p><b>Rising Edge:</b> Increment position on the rising edge of the input pulse.</p> <p><b>Falling Edge:</b> Increment position on the falling edge of the input pulse.</p>
Stepping Resolution	<p><b>Input Pulses:</b> Number of Input Pulses required to produce output counts. Range: 1 to 32,767. Default: 1.</p> <p><b>Output Counts:</b> Number of Output Counts per given number of input pulses. Range: 1 to 32,767. Default: 1.</p>
Invert Command	When selected, inverts commanded direction.

### 8.3.1 Pulse Smoothing

In digital position mode, the amplifier's trajectory generator can be used to create trapezoidal profiles, with programmed acceleration, deceleration and velocity, from a simple pulse train or burst of pulses. To bypass the trajectory generator while in digital or analog position modes, set the maximum acceleration to zero. The only limits in effect will now be the velocity loop velocity limit and the current limits. (Note that leaving the maximum acceleration set to zero will prevent other position modes from operating correctly.)

## Command Inputs

### 8.3.2 Pulse and Direction

In pulse and direction format, one input takes a series of pulses as motion step commands, and another input takes a high or low signal as a direction command, as shown below.

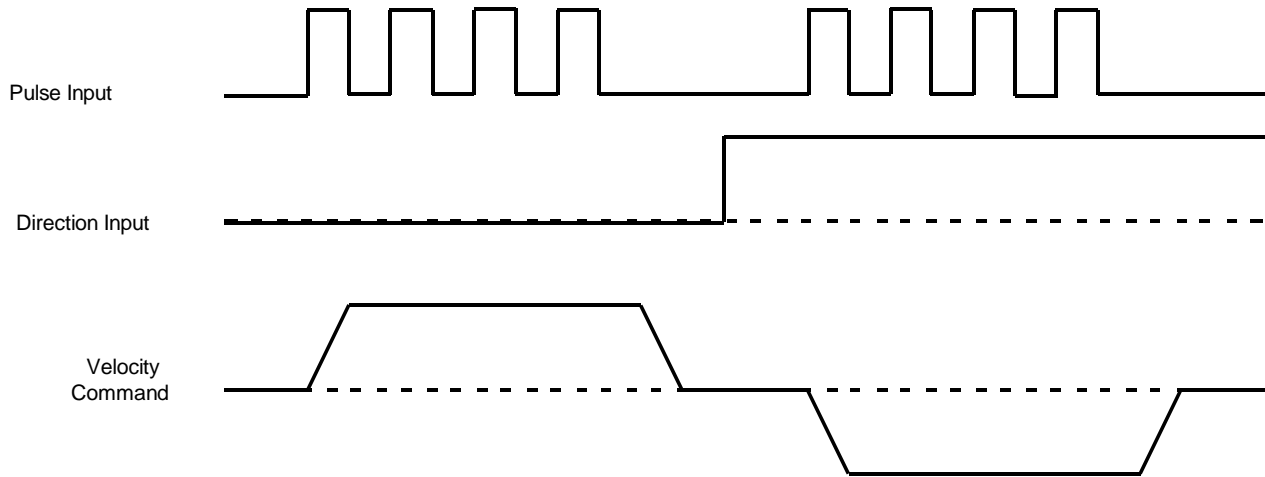

The amplifier can be set to increment position on the rising or falling edge of the signal. Stepping resolution can be programmed for electronic gearing.

### 8.3.3 Count Up/Count Down

In the count up/count down format, one input takes each pulse as a positive step command, and another takes each pulse as a negative step command, as shown below.

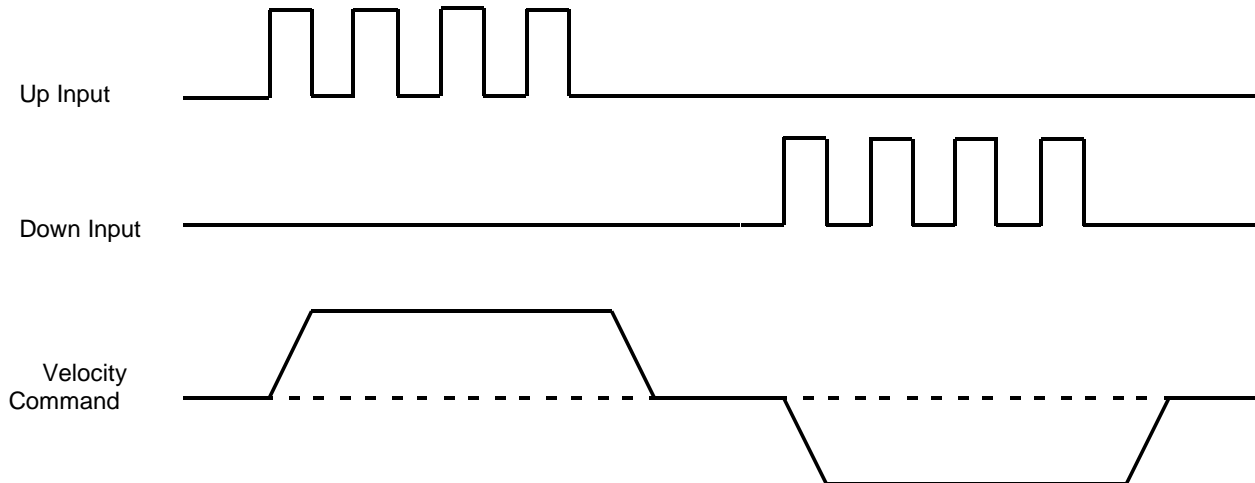

The amplifier can be set to increment position on the rising or falling edge of the signal. Stepping resolution can be programmed for electronic gearing.

### 8.3.4 Quadrature

In quadrature format, A/B quadrature commands from a master encoder provide velocity and direction commands, as shown below.

## Command Inputs

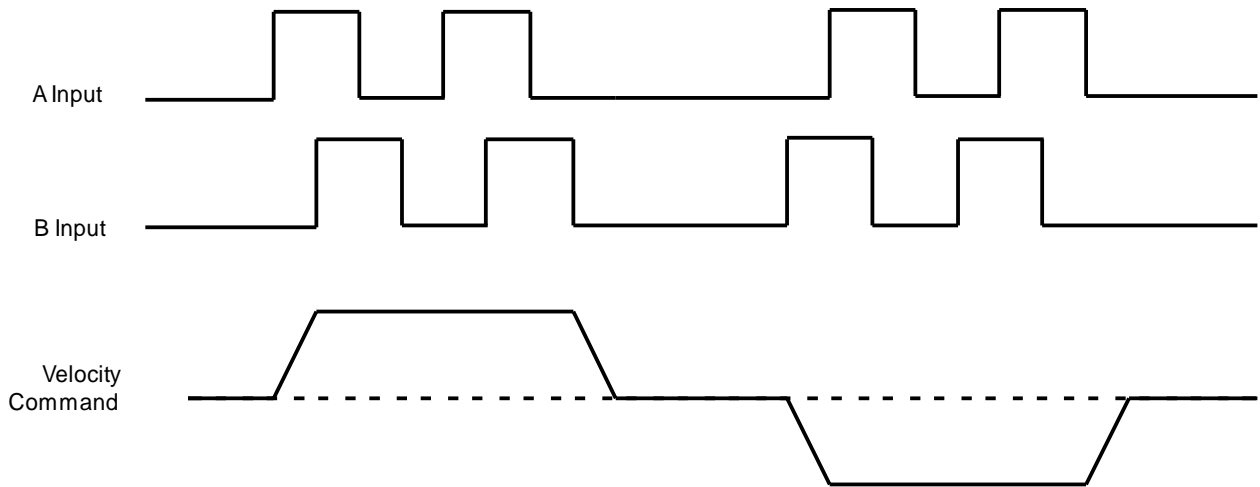

The ratio can be programmed for electronic gearing.

## 8.4 Software Programmed Input Settings

These settings can be saved to flash to allow default conditions to be set and used when the amplifier is powered up or reset.

### 8.4.1 Programmed Position

Click the Programmed Position button  on the Main screen.

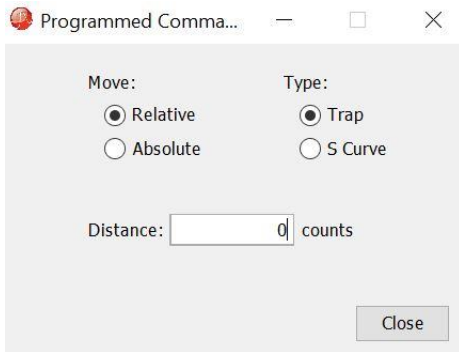

Setting	Description
Move	Relative or Absolute.
Type	Trap or S-Curve.
Distance	Move distance (relative) or location (absolute)

### 8.4.2 Programmed Velocity

Click the Programmed Velocity button  on the Main screen.

## Command Inputs

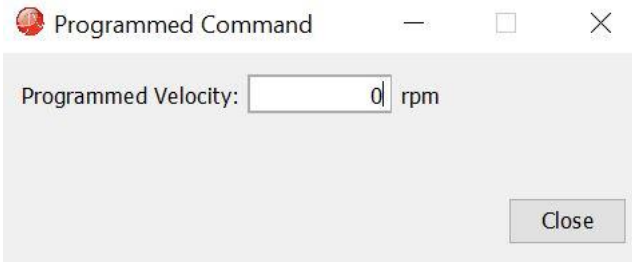

**DANGER**

### **Potential for unexpected movement.**

If the Programmed Velocity is set to values other than 0, the motor will move after power-up or reset if the amplifier is hardware enabled.

**Failure to heed this warning can cause equipment damage, injury, or death.**

<b>Setting</b>	<b>Description</b>
Programmed Velocity	Move velocity. Units: rpm (rotary) or mm/s (linear).

### 8.4.3 Programmed Current

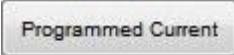
Click the Programmed Current button  on the Main screen.

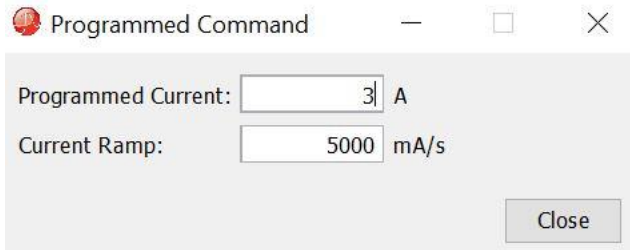

**DANGER**

### **Potential for unexpected movement.**

If the Programmed Current is set to values other than 0, the motor will move after power-up or reset if the amplifier is hardware enabled.

**Failure to heed this warning can cause equipment damage, injury, or death.**

<b>Setting</b>	<b>Description</b>
Programmed Current	Current applied during the constant velocity portion of the move. Units: A.
Current Ramp	Acceleration/deceleration current. Units: mA/s.

## 9 NETWORK CONFIGURATION

### 9.1 CANopen Network

A CANopen network can support up to 127 nodes. Each node must have a unique and valid seven-bit address (Node ID) in the range of 1-127. (Address 0 should only be used when the amplifier is serving as a CME serial port multi-drop gateway.)

1. Verify that the CAN network has been cabled and terminated as per amplifier documents.

2. Click CAN Configuration  to open the CAN Configuration screen. (If CAN is not the Position Loop Input, choose **Amplifier**→**Network Configuration** instead).

3. Choose a Bit Rate and choose any combination of address sources (Switch, Inputs, and Programmed Value). The address is the sum of the values from these sources.
4. For each source selected, perform the additional steps described below.

Source	Additional Steps
Use Switch	Verify the S1 switch setting. (Assigns values for Bit 0 – Bit 3 of CAN address.)
Use Inputs	Enter <b>Number of Inputs</b> , then choose inputs to represent each CAN address bit.
Use Programmed Value	Enter the <b>Programmed Value</b> .



## Network Configuration

- Click **Save & Reset** to save changes to amplifier flash, close the screen, and reset the amplifier. Click **Save & Close** to save changes to amplifier flash without resetting.

NOTE: Address and bit rate changes take effect only after power-up or reset.

## 9.2 MACRO Network

A Delta Tau PMAC card can hold up to four MACRO IC's, each of which is a master on a MACRO ring. Each master IC can address 16 stations (nodes, slaves), enabling the addressing of up to 64 devices on a ring. Of these, 32 can be motion devices such as Xenus XML. A node address is an 8-bit value with bits 7-4 addressing the master IC and bits 3-0 addressing the slave.

XML switch S1 is set to select the master IC to which the Xenus will be linked. The four possible values for this setting are 0,1,2, and 3.

As a MACRO station or node the XML has eight available addresses as a motion control device. These are 0,1,4,5,8,9,12, & 13.

- Verify the S1 and S2 switch settings.
- Select Amplifier→Network Configuration from the CME Main Screen to open the MACRO Configuration screen as shown in the following example.

Parameter	Description
Scaling Input Command	<p><b>Current mode:</b> output current produced by +10 Vdc of input. Range: 0 to 10,000,000 A. Default: Peak Current value.</p> <p><b>Velocity mode:</b> output velocity produced by +10 Vdc of input. Range: 0 to 100,000 rpm (mm/sec). Default: Maximum Velocity value.</p>

## Network Configuration

Heart Beat Time Out	The frequency at which the drive will produce heartbeat messages. This parameter may be set to zero to disable heartbeat production.
Home Status Bit	<b>Use Motor Encoder index:</b> Return the primary encoder index state in the home status bit of the MACRO status word. <b>Use Home Input:</b> The state of any general purpose input configured as a home input will be returned in the home status bit of the MACRO status word.
Auxiliary Data Registers	Defines what type of additional data is transmitted in the Auxiliary data registers of every MACRO response message. <b>First Register:</b> Digital input Value, Secondary Analog Input Value. <b>Second Register:</b> Analog Input, Motor Encoder, Position Encoder.
Enable Position Output Scaling	When selected, position data sent over the MACRO network is shifted up 5 bits to be compatible with Delta-Tau controllers.
Enable MACRO Network Synchronization	Allows the drive's PWM frequency to be adjusted to allow synchronous operation with the MACRO ring. Note that changing the PWM Frequency will affect the current loop tuning. Therefore, current loop tuning will need to be checked.
Current Loop Frequency	
Active Network Required for Amp to Enable	If selected, drive will not enable if network is not active.

## 9.3 EtherCAT Network

An EtherCAT network enables high-speed control of multiple axes while maintaining tight synchronization of clocks in the nodes. Data protocol is CANopen over EtherCAT (CoE) based on DSP-402 for motion control devices.

Stations on EtherCAT are automatically addressed by their bus location. The first drive on the network is station address -1. The second is -2, and so on.

As an alternate to the default addressing, switches S1 and S2 may be used to program a station alias. The default address and station alias are always available. If the switch-based station alias is used, it is the responsibility of the user to ensure that each drive has a unique station alias.  
EtherCAT Address (Station Alias)

1. View the S1 and S2 switch settings on the drive.
2. Verify the S1 and S2 switch settings select Amplifier→Network Configuration from the CME Main Screen to open the EtherCAT Settings screen as shown in the following example.

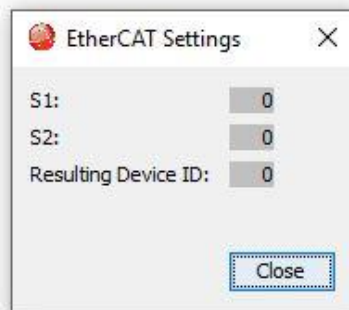

## 10 FAULTS

### 10.1 Overview

#### 10.1.1 Latched vs Non-latched Faults

When a fault is configured to be latched, the fault can only be cleared after the fault has been corrected and at least one of the following actions has been taken:

- Power-cycle the amplifier
- Cycle (disable and then enable) an input that is configured as Enable with Clear Faults or Enable with Reset
- Open the Control Panel and press **Clear Faults** or **Reset**
- Clear the fault over the CANopen network or serial bus

A non-latched fault will be cleared when the fault condition has been removed. This can occur without operator intervention.



**DANGER Risk of unexpected motion with non-latched faults.**

After the cause of a non-latched fault is corrected, the amplifier re-enables the PWM output stage without operator intervention. In this case, motion may re-start unexpectedly. Configure faults as latched unless a specific situation calls for non-latched behavior. When using non-latched faults, be sure to safeguard against unexpected motion.

**Failure to heed this warning can cause equipment damage, injury, or death.**

#### 10.1.2 Example

The drive's temperature reaches the fault level. The drive reports the fault and disables the PWM output. Then, the drive temperature falls below the fault level.

**Non-latched fault operation:**

The fault is cleared and the amplifier's PWM outputs are enabled without operator intervention.

**Latched fault operation:**

The fault remains active and the drive's PWM outputs remain disabled until the faults are cleared as described above.

1. Click the Configure Faults button  on the Main screen.

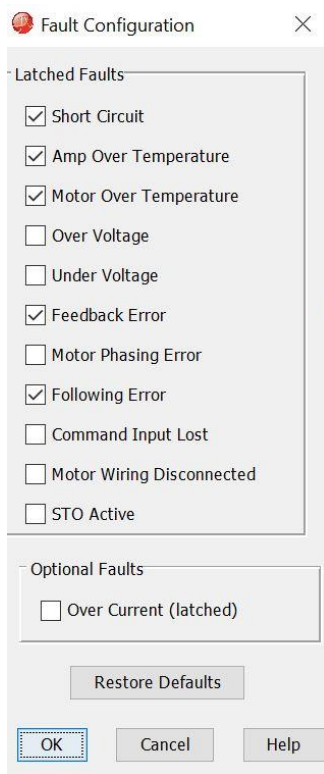

2. Select the faults to latch. See [Fault Descriptions](#).
3. Click **OK** to close screen and save changes to amplifier RAM.
4. On the Main screen, click **Save to Flash**  to avoid losing the changes.

## 10.2 Fault Descriptions

Note: The list of faults may vary with amplifier model.

Fault Description	Fault Occurs When...	Fault is Corrected When...
*Amp Over Temperature	Amplifier's internal temperature exceeds specified temperature.	Amplifier's internal temperature falls below specified temperature.
Motor Phasing Error	Encoder-based phase angle does not agree with Hall switch states. This fault can occur only with brushless motors set up using sinusoidal commutation. It does not occur with resolver feedback or with Halls correction turned off.	Encoder-based phase angle agrees with Hall switch states. See <a href="#">Troubleshoot Manual Phase w/ Encoder and Halls</a>
*Feedback error	Over current condition detected on output of the internal +5 Vdc supply used to power the feedback.	Encoder power returns to specified voltage range.

	Resolver or analog encoder not connected or levels out of tolerance. Differential signals from incremental encoder not connected.	Feedback signals stay within specified levels. Differential signals connected.
*Motor Over Temp	Motor over-temperature switch changes state to indicate an over-temperature condition.	Temperature switch changes back to normal operating state.
Under Voltage	Bus voltage falls below specified voltage limit.	Bus voltage returns to specified voltage range.
Over Voltage	Bus voltage exceeds specified voltage limit.	Bus voltage returns to specified voltage range.
*Following Error	User set following error threshold exceeded.	See <a href="#">Following Error Fault Details</a>
*Short Circuit Detected	Output to output, output to ground, internal PWM bridge fault.	Short circuit has been removed.
Command Input Lost	PWM or other command signal not present.	Command signal restored.
Over Current (Latched)	Output current I <sup>2</sup> T limit has been exceeded.	Amplifier is reset and re-enabled.
Motor Wiring Disconnected	The drive detects that it cannot push current through the motor windings	The motor is reconnected.
STO Active	STO Activated for safe torque off	STO is deactivated and fault is cleared
*Latched by default.		

## 11 MOTOR PHASING

### Auto Phase

The examples in this chapter show amplifier operating modes and motor feedback configurations. Some screens and choices may vary from those described here.

#### 11.1.1 Auto Phase Example: Servo Amplifier

NOTE: The following steps show Auto Phase with a brushless rotary motor, digital Halls, and an incremental quadrature encoder. Screens vary for other configurations.

1. Verify that the Enable Input is active and that HV or AC power is applied.
2. Click **Auto Phase**  to open the Auto Phase wizard.



3. Move the motor in the direction to be considered positive

OR

If you cannot move the motor, click **Skip** (you will confirm motor direction later).

NOTE: If an output is configured as a brake you can temporarily release the brake by holding down the **Release Brake** button. The brake will be reactivated when you release the button. Warning if working with vertical axis releasing the Brake may cause system to drop!

## Motor Phasing

4. Click **Next** to go to the Motor Wiring Setup step:

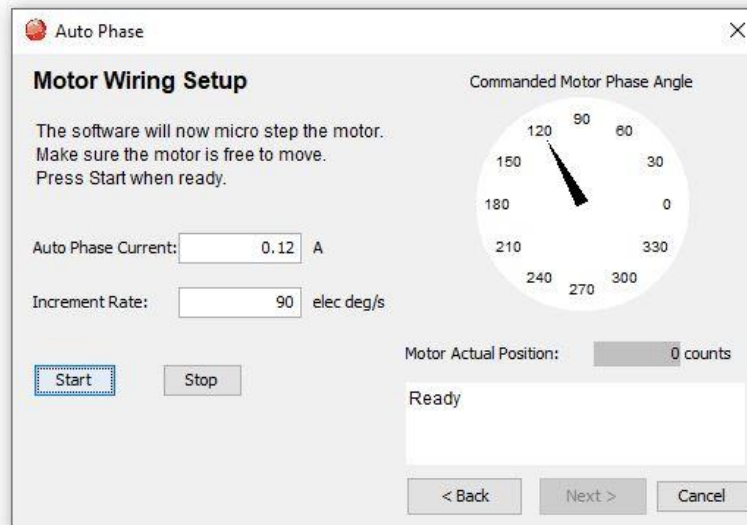

5. Activate the Enable Input.
6. Click **Start** to begin the motor wiring setup.  
The message area displays messages: Configuring Initial Settings, Microstepping, Test Complete, Motor Wiring has been configured.

During microstepping, a current vector is applied to the motor windings and microstepped through an electrical cycle at a set rate, causing the motor to move.

If you chose to **Skip** the motor direction setup step, Auto Phase will prompt for confirmation of correct motor direction.

If the step fails, see [Troubleshooting the Auto Phase Problems](#).

NOTE: If incorrect values were entered for inductance and resistance, the calculated  $C_p$  and  $C_i$  values may produce current loop oscillation, evidenced by an audible high frequency squeal during auto phasing.

7. Click **Next** to go to the Phase Count Test step.

## Motor Phasing

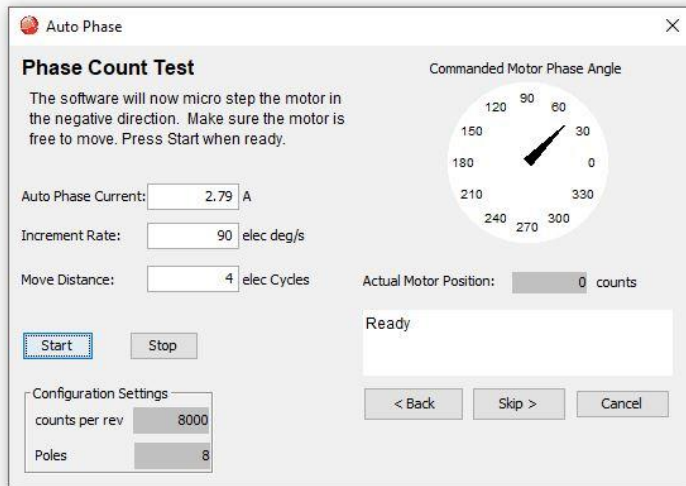

8. Click Start to begin the Phase Count Test. Observe status messages. See the prompt:

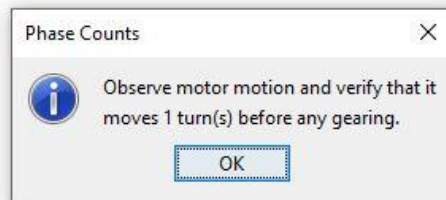

9. When you are ready to observe motion, click **OK**.  
When motion is complete the prompt will be displayed:

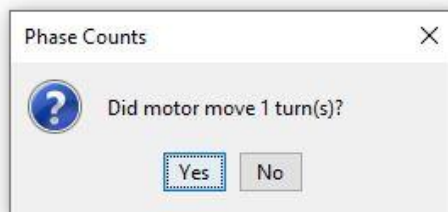

If motor did not turn 1 full turn, click **No** and see [Phase count](#) test.

If motor turned 1 full turn, click **Yes**.

10. For a resolver (-R) version of a Copley Controls amplifier, skip to Step 12.  
For a non-resolver amplifier, click **Next** to open the Hall Wiring Setup screen.



## Motor Phasing

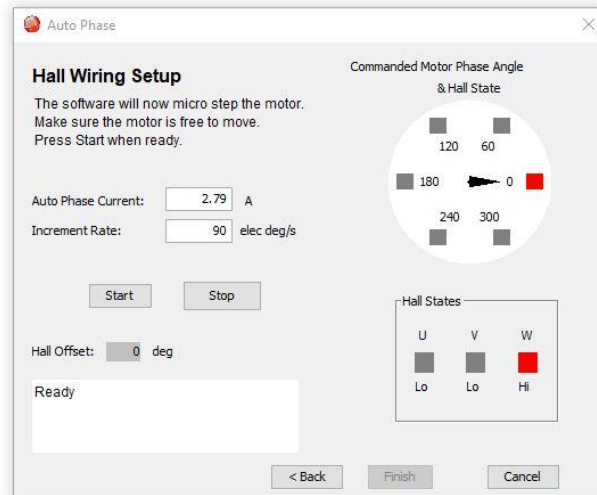

11. Click **Start** to begin the Halls wiring setup. The message area displays the messages: Microstepping. Test Complete. Motor has been properly phased.

During microstepping, a current vector is applied to the motor windings and microstepped through an electrical cycle at a set rate, causing the motor to move. As the motor moves the Hall lines are decoded for proper commutation.

If the step fails, see [Halls wiring](#) setup.

12. For a resolver (-R) version of a Copley Controls amplifier, click **Next** to open the Resolver Phase Angle Setup screen.

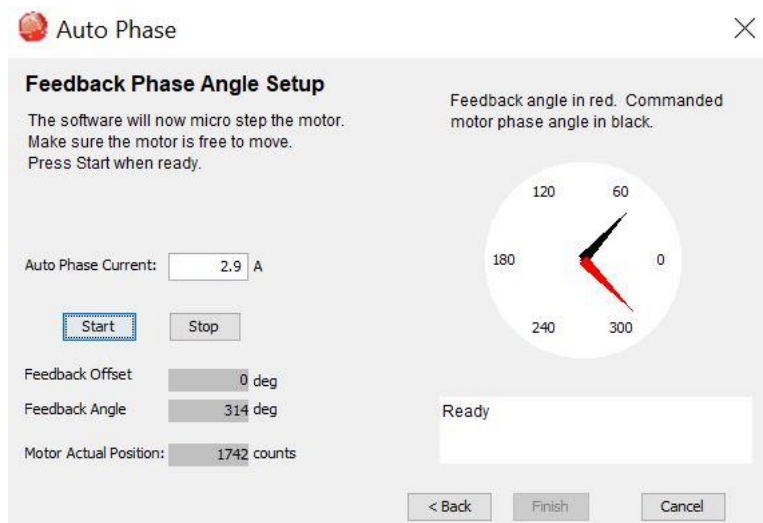

13. Click **Start** to start the resolver phase angle setup. The message area displays status messages.
14. Click **Finish** to close the screen and save values to flash memory OR to close the screen without saving changes, click Cancel.
15. If the Auto Phase algorithm does not produce desired results, try adjusting the Auto Phase Current and Increment Rate values, using the guidelines in [Tips for Auto Phase Current and Increment Rate](#).
16. If desired results are not obtained, or to confirm results, proceed to [Manual Phase](#).

## Motor Phasing

### 11.1.2 Auto Phase Example: Stepper Amplifier, No Encoder

1. Verify that the Enable Input is active and that HV power is applied.
2. Click **Auto Phase**  to open the Auto Phase Motor Direction Setup screen.

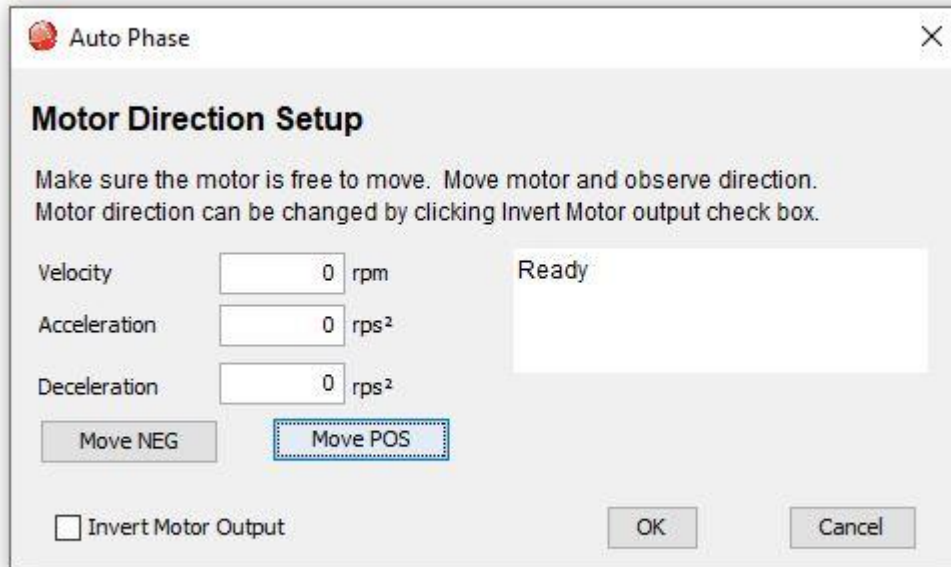

3. Hold down **Move POS** to move the motor in the direction considered positive and observe the direction of movement.  
If the motor does not move see [Troubleshooting the Auto Phase Problems](#).
4. If the motor moved opposite the direction that you wish to program as positive, click **Invert Motor Output**.
5. Click **OK** to save the direction setting.

### 11.1.3 Auto Phase Example: Stepper Amplifier with Encoder, in Stepper Mode

1. Verify that the Enable Input is active and that HV power is applied.
2. Click **Auto Phase**  to open the Auto Phase Motor Direction Setup screen.

## Motor Phasing

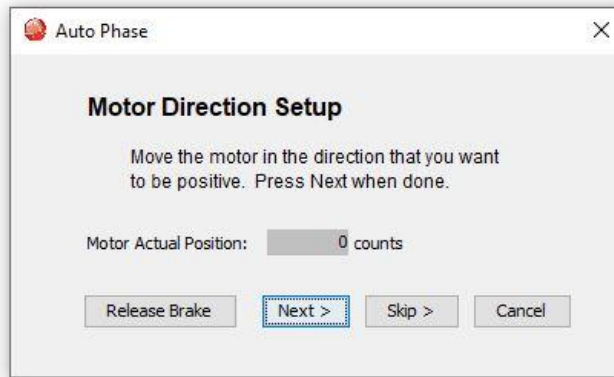

3. Move the motor in the direction you wish to be considered positive.
4. Activate the Enable Input.
5. Click **Next** to open the Auto Phase Motor Wiring Setup screen.

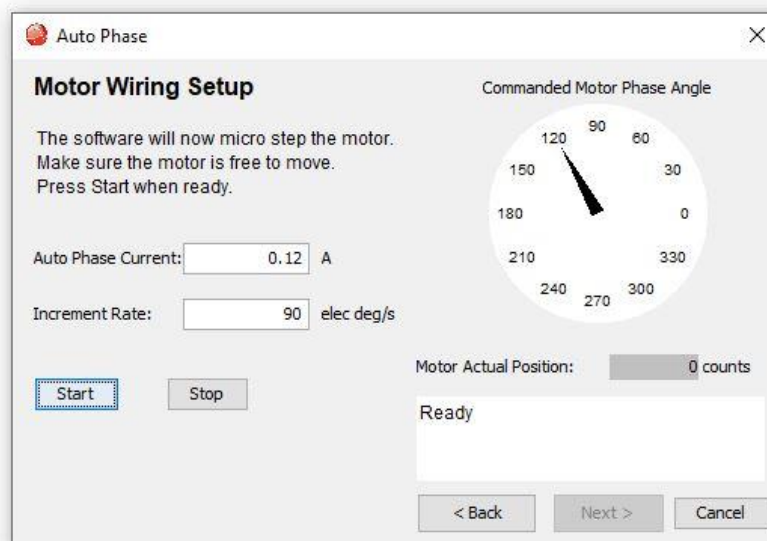

6. Click **Start** to begin motor wiring setup with default values. After successful motor wiring setup, the message "Test Complete" appears.
7. Click **Finish** to close the screen and save values to flash memory.

### 11.1.4 Auto Phase Example: Stepper Amplifier with Encoder, in Servo Mode

1. Verify that the Enable Input is active and that HV power is applied.

## Motor Phasing

2. Click **Auto Phase**  to open the Auto Phase Motor Direction Setup screen.

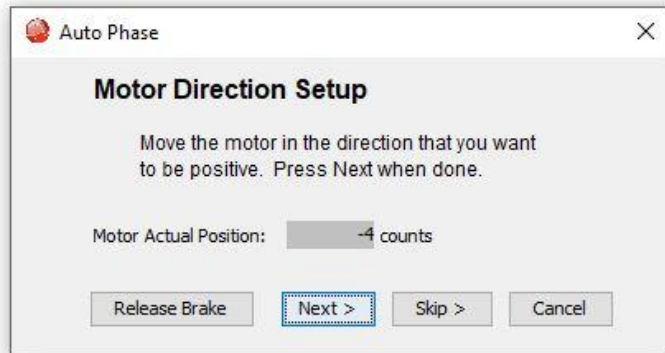

3. Move the motor in the direction you wish to be considered positive.
4. Activate the Enable Input.
5. Click **Next** to open the Auto Phase Motor Wiring Setup screen.

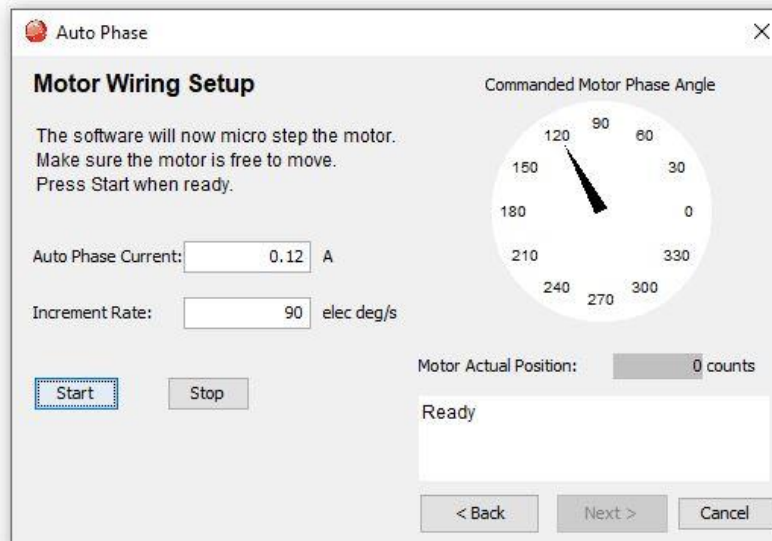

6. Click **Start** to begin the motor wiring setup. The message area displays messages: Configuring Initial Settings, Microstepping, Test Complete, Motor Wiring has been configured.

During microstepping, a current vector is applied to the motor windings and microstepped through an electrical cycle at a set rate, causing the motor to move.

If you chose to **Skip** the motor direction setup step, Auto Phase will prompt for confirmation of correct motor direction.

If the step fails, see [Troubleshooting the Auto Phase Problems](#)

NOTE: If incorrect values were entered for inductance and resistance, the calculated  $C_p$  and  $C_i$  values may produce current loop oscillation, evidenced by an audible high frequency squeal during auto phasing. Click **Next** to open the Auto

## Motor Phasing

Phase Count Test screen.

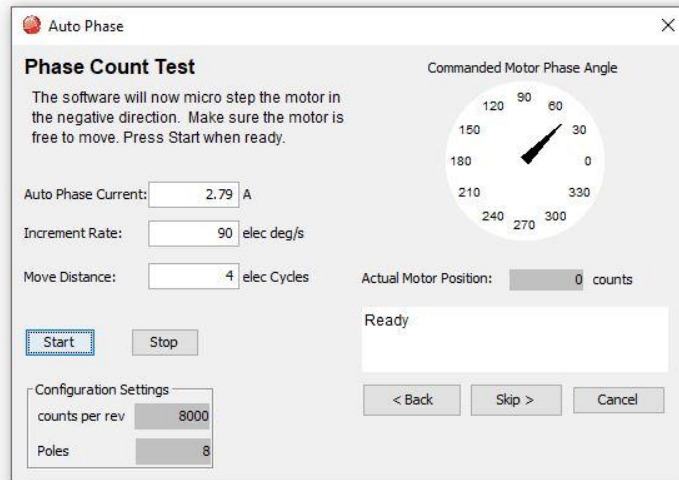

8. Click **Start** to begin the Phase Count Test. Observe status messages. See the prompt:

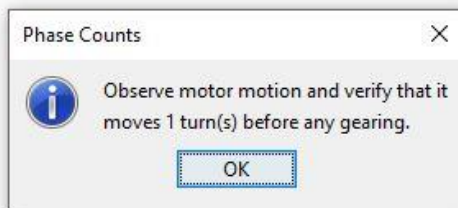

9. When you are ready to observe motion, click **OK**. See the prompt:

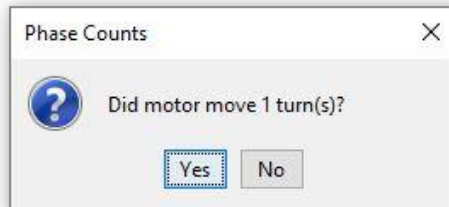

## Motor Phasing

10. Click **Next** to open the Auto Phase Motor Phase Initialize screen:

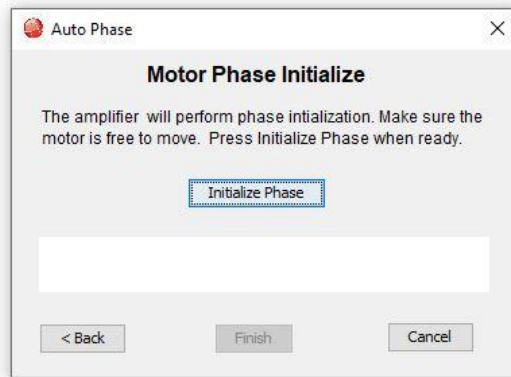

11. Click Initialize Phase to start phase initialization. If successful, this message appears: "Test Complete. Phasing has been initialized."

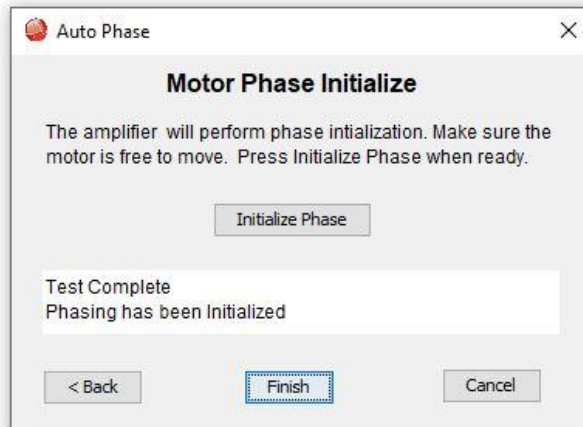

12. Click **Finish** to close the screen and save values to flash memory.

## 11.2 Tips for Auto Phase Current and Increment Rate

- If friction is high, more current may be required to move the load.
- High static friction may require more current to overcome stiction.
- Transition from static friction to dynamic friction, and back, may produce jerky motion.
- A faster increment rate will operate in the dynamic friction range.
- A slower rate will operate in the static friction range.
- If the friction is low, as in the case of air bearings, low frequency oscillations may occur; thus, less current and slower rates may be required. If oscillations persist, then friction may need to be temporarily added.

## 11.3 Troubleshooting the Auto Phase Problems

### 11.3.1 Motor direction setup

If motor direction setup step failed:

- Check Encoder or resolver power and signals.

## Motor Phasing

- Verify that the encoder is differential. (Contact factory if encoder is single-ended.)
- Check shielding for proper grounding.

### **11.3.2 Motor wiring setup**

If motor wiring setup step failed:

- Verify that amplifier is disabled.
- Check for mechanical jamming.
- Check for smooth motion with no mechanical jerking.
- Check for good connections to the motor power wires.
- Disconnect motor power wires and measure for proper motor resistance.

### **11.3.3 Phase count test**

If phase count test failed:

- Verify that in the Motor/Feedback screen the following parameters have been set correctly:
- Number of Poles for rotary motors. Verify the motor's pole count with the [Data accuracy test](#).
- Magnetic Pole Pair Length for linear motors.
- Encoder Lines or Fundamental Lines for rotary encoders.
- Encoder Resolution for linear encoders.

### **11.3.4 Halls wiring setup**

If Halls wiring setup step failed:

- Check Halls power and signals.
- Check for smooth motion with no mechanical jerking.
- Check shielding for proper grounding.

If the auto phase procedure fails despite these corrective measures, see [Manual Phase](#).

## **11.4 Manual Phase**

1. Remove load from the motor.

## Motor Phasing

- On the Main screen, choose **Tools**→**Manual Phase** to open the window:

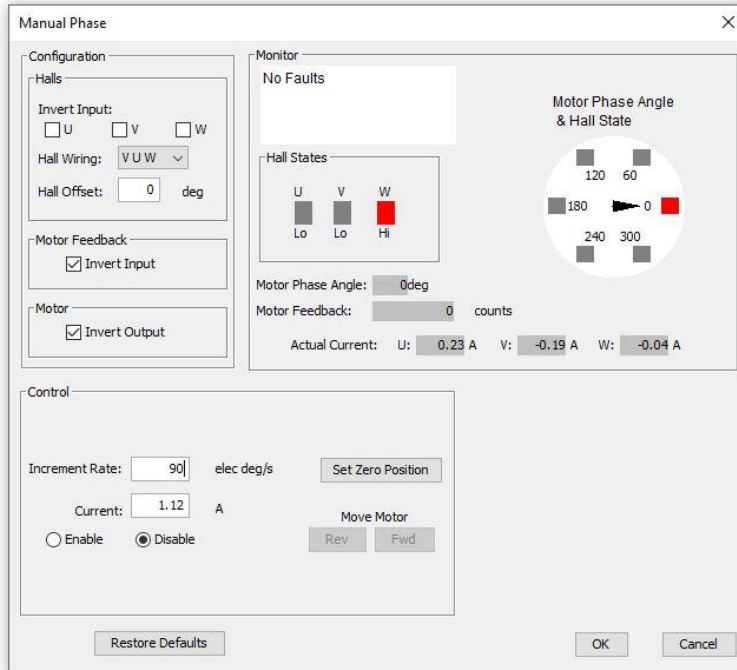

- Verify the **Current** setting before enabling the drive.



- To control the current vector rotation, command the motor forward or reverse.

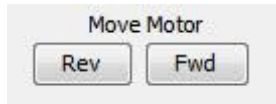

NOTE: Some motors have bearings stiction, so helping the motor with mechanical force is acceptable. Motors with no friction may need friction added to steady motion.

- If the motor cannot keep up with the rate of vector rotation, then reduce the Increment Rate or increase the Current.
- Verify that pressing forward button moves motor forward.  
If the motor moves in the wrong direction, toggle the **Motor Invert Output** setting.
- Verify actual position count agrees with direction of rotation: increasing counts in forward direction and decreasing counts in reverse direction. If it does not, toggle the Motor Feedback Invert Input box setting.
- If the motor has no Halls, skip to [Phase Initialization for Motor without Halls](#).
- Monitor the vector rotation through one electrical cycle for proper Hall transitions:
  - Verify that the red indicator rotates in the same direction as the motor phase angle, and that the transition occurs when the needle is between indicators ( $\pm 30$  degrees, as shown below).

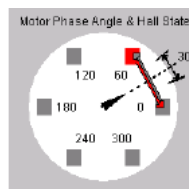



## Motor Phasing

- If the needle and Hall states do not track properly, use the Hall Wiring list box and/or Invert Input options (shown below) to swap the amplifier's Hall wire configuration.

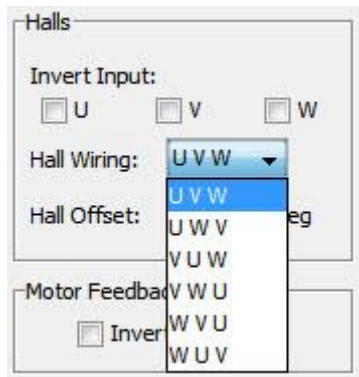

- If the red indicator transition leads or lags behind the centered needle by more than 30 degrees, then try adjusting the Hall Offset in +/- 30 degree increments:



10. Phasing of a motor with encoder and Halls is complete. Click **OK**.

### 11.4.1 Phase Initialization for Motor without Halls (Algorithmic Phase Initialization Mode)

The Phase Initialization is designed to phase a motor with no Halls.



**DANGER**

**Halls are strongly recommended for safe, redundant system.**

Copley strongly recommends the use of Halls or a commutating encoder for commutation to provide a safe, redundant system. If the application requires otherwise, the customer accepts responsibility for verifying system performance and reliability.

**Failure to heed these warnings can cause equipment damage, injury, or death.**

The Phase Initialization function uses as little motion as possible (less than 1/3 of one electrical cycle) to determine phasing. Phase Initialization drives the motor in open loop current mode, using microstepping of a current vector.

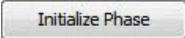
1. Ensure that the motor is free to move (for instance, make sure the brake is OFF).
2. Ensure that no external force, such as gravity, will cause the motor to move. If it is not practical to eliminate such forces, it may be necessary to use the **Forced Phase** feature later in this procedure.
3. To phase a motor with an encoder and no Halls, click **Initialize Phase** . Observe the status messages under Monitor.
4. If the message "Phase Initialized" appears, the phasing of a motor with encoder and no Halls is complete. Click **OK** to close the Manual Phase window.

## Motor Phasing

If the phasing function fails (for instance, message “Phase Initialized” is not displayed, or if a phasing fault is indicated) adjust the phase initialization settings described below and try Step 4 (**Initialize Phase**) again.

Setting	Description
Time	Used first as a delay, allowing amplifier to ramp up current to drive a small move. Then used as a settling time. If the value is too low, the settling may not occur in time, possibly resulting in jerky motion. Default: 400 ms.
Current	Use to overcome stiction when rotating current vector. If the current is too large, motion may not settle; a low value may not provide enough current to drive a move.
Forced Phase	When selected, Forced Phase causes the Phase Initialization function to apply Phase Init Current to alternate pairs of motor wires using the Phase Init Time. Forced Phasing has been used to overcome various phasing problems, including situations where gravity introduces unwanted motion. Forced Phasing tends to produce more jerk and apparent motion.
Increment Phase 90 deg	If set, the amplifier will increase the starting phase angle by 90 degrees after every failed initialization attempt.
Use Offset	If set, the amplifier uses the Hall Offset value as the initialization starting angle.

### 11.4.2 Manual Phase Example: Motor with Resolver

1. Make sure that no load is connected to the motor.
2. On the Main screen, choose **Tools**→**Manual Phase** to open the window:

## Motor Phasing

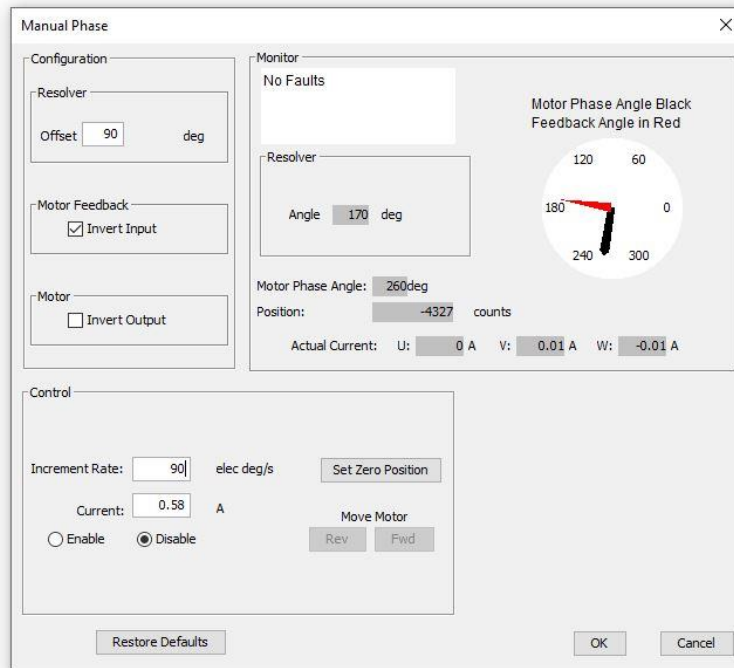

3. Verify the **Current** setting before enabling the drive



To control the current vector rotation, command the motor forward or reverse.



NOTE: Some motors have bearings stiction, so helping the motor with mechanical force is acceptable. Motors with no friction may need friction added to steady motion.

4. If the motor cannot keep up with the rate of vector rotation, then reduce the Increment Rate or increase the Current.
5. Verify that pressing forward button moves motor forward. If it does not, toggle the Motor Invert Output box setting.
6. Verify actual position count agrees with direction of rotation: increasing counts in forward direction and decreasing counts in reverse direction. If it does not, toggle the Motor Feedback Invert Input box setting.
7. Adjust Resolver Offset configuration as required, testing **Fwd** and **Rev**, to produce alignment of Motor Phase Angle with Resolver Angle as shown here.

## Motor Phasing

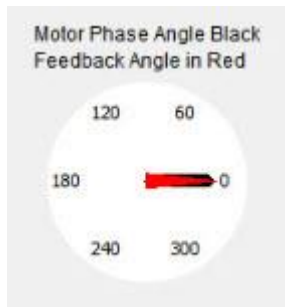

Note: Motor manufacturers typically align the resolver in 30 degree increments, typically by applying current through a pair of motor power wires.

### 11.5 Troubleshoot Manual Phase w/ Encoder and Halls

To perform trapezoidal commutation after power-up or reset, the amplifier must receive good Hall signals. After the first Hall transition is detected, then sinusoidal commutation can be performed. In sinusoidal commutation, the amplifier uses the encoder for commutation while monitoring the Halls to verify proper phase. If the error between the encoder count and Hall transition is too large, then the Hall phase correction will not be performed and a phase fault will be triggered.

Test for phase fault problems in the order shown below.

#### 11.5.1 Data accuracy test

1. Verify the motor's pole count:
  - Apply a current vector at zero Increment Rate to lock motor in position.
  - Turn the motor shaft and count the number of distinct locking positions.
  - Calculate the number of poles: Poles = number of locking positions \* 2
2. Verify the encoder line count OR a linear motor's magnetic pair length and the encoder resolution.

#### 11.5.2 Encoder wiring test

If the Halls produce good trapezoidal commutation but a phase fault is persistent in sinusoidal commutation mode, the encoder is highly suspect:

- Verify the differential encoder signals.
- Verify proper twisted shielded cable with good grounding.
- Disable the amplifier and move the motor manually to test for phase fault.
- If phase fault only occurs under command of current, make sure the motor power cable is not bundled with the encoder cable.

#### 11.5.3 Hall signals test

If the Halls signals are suspected to be faulty:

- Make sure Halls change states as the motor moves through one electrical cycle.
- Some Hall signals are noisy and require filtering. Check with motor manufacturer.
- Some Halls are not properly calibrated to the motor manufacturer's specification.

#### 11.5.4 Hall transition test

If the location of the Hall transition is not within +/-30 degrees:

- Adjust Hall offset in smaller increments.
- Verify Hall alignment.
- Make sure motion is smooth.

## 12 CONTROL LOOPS

### 12.1 Current Loop Setup and Tuning

Initial current loop proportional gain (**Cp**) and current loop integral gain (**Ci**) values can be calculated with [Calculate](#).

Click I Loop  to open the Current Loop screen:

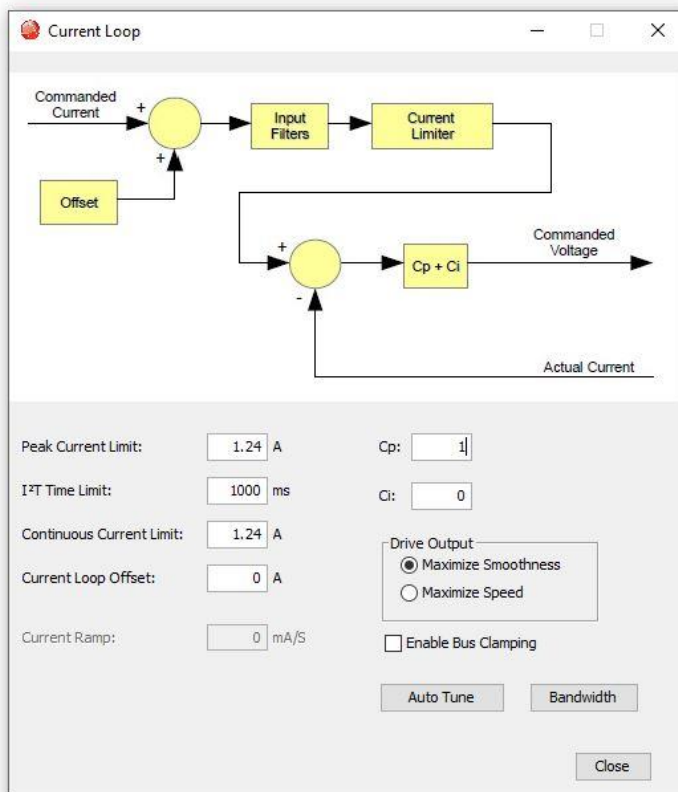

Parameter	Description
Peak Current Limit	Used to limit the peak phase current to the motor. Max value depends upon the amplifier model; Min value > continuous limit.
I <sup>2</sup> T Time Limit	Sets I <sup>2</sup> T Time Limit in ms. See I <sup>2</sup> T Limit Algorithm.
Continuous Current Limit	Used to limit the Phase Current. Max Value is < Peak Current and depends upon the amplifier model. Min value: 0
Current Loop Offset	Sets current loop offset. Leave it set to zero until after tuning. For more information, see
Cp	Current loop proportional gain. Range 0 – 32,767.
Ci	Current loop integral gain. Range 0 – 32,767.
Current Ramp (mA/s)	Used only when in current mode. Default value is 0 which disables the ramp rate limit.
Drive Output	<b>Maximize Smoothness:</b> Amplifier uses circular vector limiting to produce smooth operation even into the voltage limits.

	<b>Maximize Speed:</b> Allows for slightly more of the bus voltage to be used when in the voltage limit. This may produce a small disturbance at top speed.
Enable Bus Clamping	Checking the option disables space vector modulation and may reduce 120 Hz AC line ripple when holding position near zero current. If unchecked may allow for higher speeds.
Auto Tune	See <a href="#">Current Loop Auto Tune</a> .
Bandwidth	Measure bandwidth using the Cp and Ci values now in the amplifier.

### 12.1.1 Current Loop Manual Tune

**NOTE:**

- During tuning, observe any warnings or faults that appear in the status bar of the scope.
- Some users prefer the Auto Tune feature. See [Current Loop Auto Tune](#).

1. Click the Scope Tool .

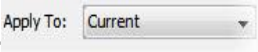
2. Choose **Current**  from the Function Generator Apply To: drop list.

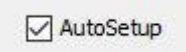
3. On the Settings tab, make sure Auto Setup  is selected. Auto Setup automatically sets the following parameters:

<b>Function Generator Tab</b>	
<b>Parameter</b>	<b>Description</b>
Function	Square Wave.
Amplitude	10% of continuous current value.
Frequency	100 Hz.
<b>Settings Tab</b>	
Channel 1	Commanded current (green).
Channel 2	Actual current (white).

4. Verify that the Amplitude value  is not excessive for the motor.

5. Click **Start** .

6. On the **Gains tab**, adjust current loop proportional gain (Cp) and the current loop integral gain (CI) to obtain a desired wave form.

- Set current loop integral gain (Ci) to zero.

## Controls Loops

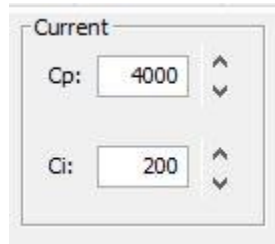

- Raise or lower  $C_p$  to obtain desired step response. (Typically, little or no overshoot with a 100 Hz, low-current square wave.) If the  $C_p$  value is too large, ringing may occur. If the  $C_p$  value is too low, bandwidth decreases.

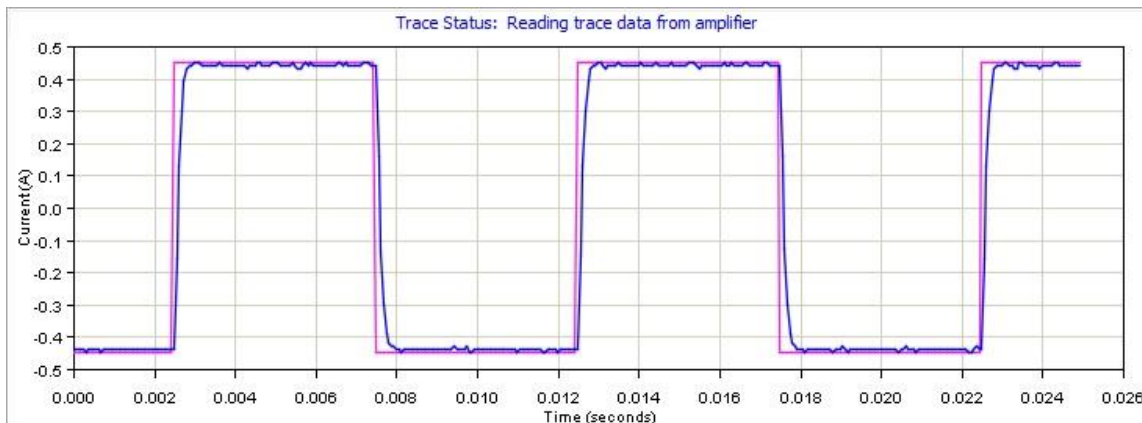

7. Adjust current loop integral gain ( $C_i$ ) until desired settling time is obtained.

**Note:** The image below shows a good example of a good current loop tuning, in which the wave forms for commanded and the actual current are very similar, without any ringing or overshoot.

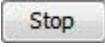

8. Press **Stop**  to stop the function generator.
9. On the Main screen, click **Save to Flash**  to avoid losing the changes.
10. On the main screen, select  and click on **Bandwidth** to measure the bandwidth. Verify that the bandwidth measured is sufficient for the application. Typical bandwidth value is 1.2kHz  $\pm$  200 Hz.

### 12.1.2 Current Loop Auto Tune

The current loop Auto Tune algorithm applies a square-wave command to the current loop and adjusts current loop proportional gain ( $C_p$ ) and current loop integral gain ( $C_i$ ) until a desirable waveform is obtained.

Initial current loop proportional gain (**Cp**) and current loop integral gain (**Ci**) values can be calculated with [Calculate](#).

1. Click I Loop  to open the Current Loop screen:

## Controls Loops

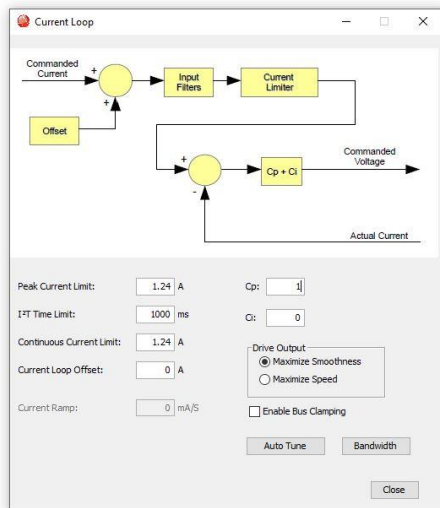

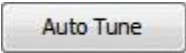
2. Verify that the amplifier is hardware enabled.
3. Click Auto Tune  to open the screen and start the Current Loop Auto Tune.

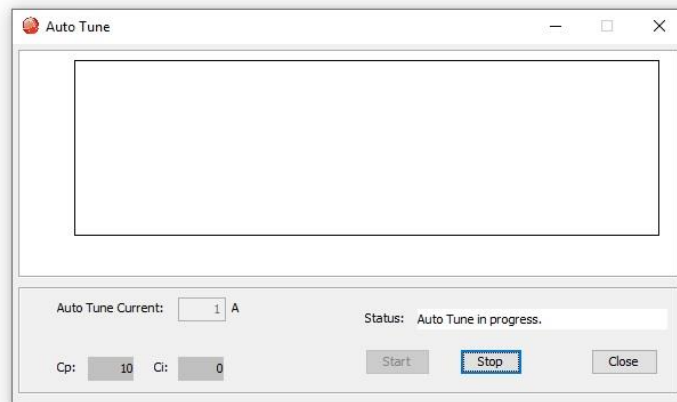

4. To Change the Auto Tune Current, click **Stop**. Enter the new current in the Auto Tune Current field, and then click **Start**.
5. Observe the Auto Tune process and results.

A typical example is given below:



## Controls Loops

- Set  $C_p$  and  $C_i$  to zero and adjust  $C_p$  and  $C_i$  for optimal values.

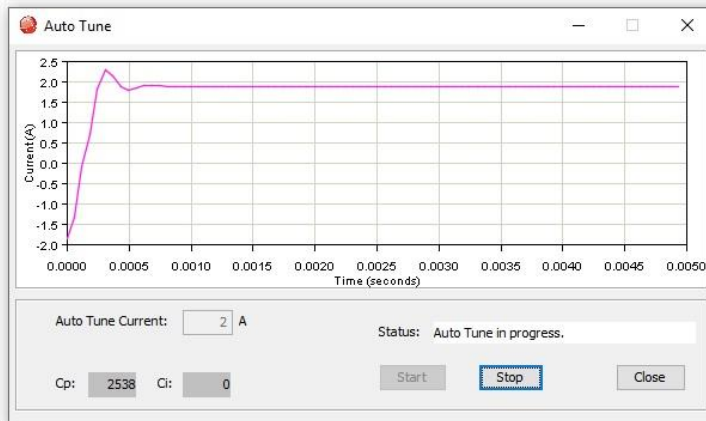

- Use a frequency sweep to determine the small signal, current loop bandwidth.

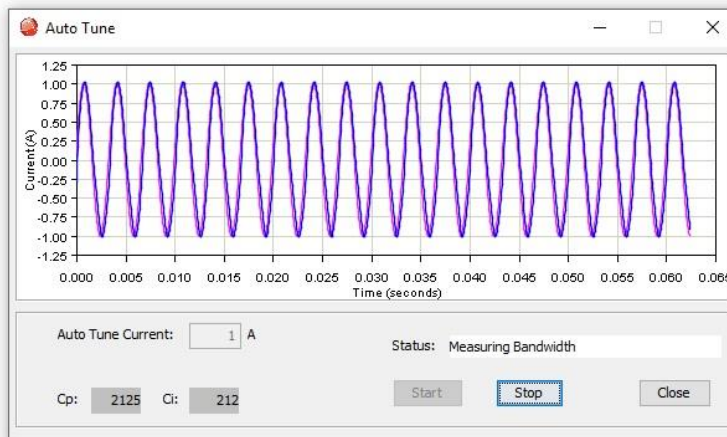

- A set of  $C_p$  and  $C_i$  alternatives, and the bandwidth measured using the high  $C_p$  and  $C_i$  values are displayed.

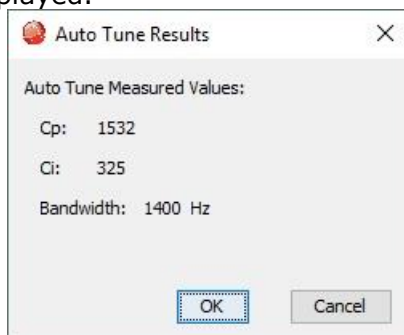

- Click **OK** to keep the new  $C_p$  and  $C_i$  values in RAM that auto tune measured. Click **Cancel** to restore the original  $C_p$  and  $C_i$  values.

### 12.1.3 Notes on the Current Mode and Current Loop

#### Current Loop Diagram

As shown below, the “front end” of the current loop is a limiting stage. The limiting stage accepts a current command, applies limits, and passes a limited current command to the summing junction. The summing junction takes the commanded current, subtracts the actual current (represented by the feedback signal), and produces an error signal. This error signal is then processed using the integral and proportional gains to produce a command. This command is then applied to the amplifier’s power stage.

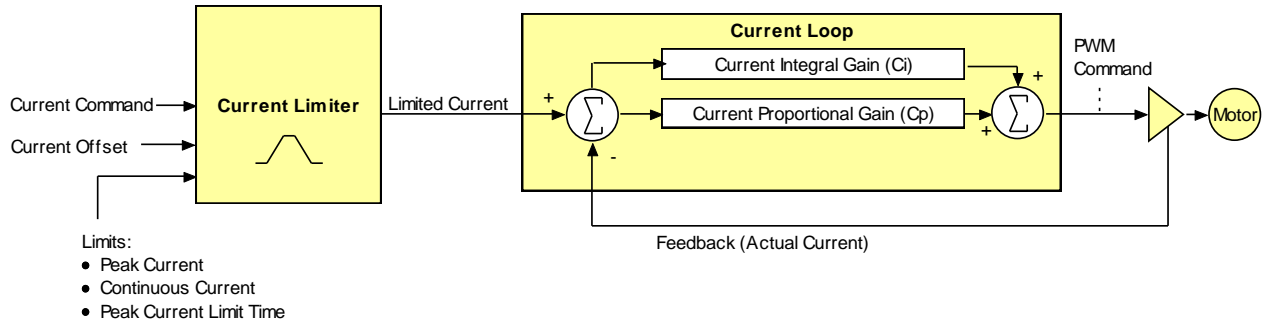

#### Current Loop Inputs

- The amplifier’s analog or PWM inputs.
- A CANopen network via the amplifier’s CAN interface.
- A Copley Virtual Motion (CVM) control program.
- The amplifier’s internal function generator.

In velocity or position modes, the current command is generated by the velocity loop.

#### 12.1.4 Offset

The current loop offset is intended for use in applications where there is a constant force applied to, or required of, the servomotor and the system must control this force. Typical applications would be a vertical axis holding against gravity, or web tensioning. This offset value is summed with the current command before the limiting stage.

#### 12.1.5 Limits

The current command is limited based on the following parameters:

Limit	Description
Peak Current Limit	Maximum current that can be generated by the amplifier for a short duration of time. This value cannot exceed the peak current rating of the amplifier.
Continuous Current Limit	Maximum current that can be constantly generated by the amplifier.
I <sup>2</sup> T Time Limit	Maximum amount of time that the peak current can be applied to the motor before it must be reduced to the continuous limit or generate a fault. For more details, see I <sup>2</sup> T Time Limit Algorithm. Note: Although the current limits set by the user may exceed the amplifier's internal limits, the amplifier operates using both sets of limits in parallel, and therefore will not exceed its own internal limits regardless of the values programmed.
Ramp	Rate of change in current command. Used to limit jog moves initiated from the Control Panel Jog function in current mode, and in advanced Indexer Program functions.

### 12.1.6 Current Loop Gains

Gain	Description
Cp - Current loop proportional	The current error (the difference between the actual and the limited commanded current) is multiplied by this value. The primary effect of this gain is to increase bandwidth (or decrease the step-response time) as the gain is increased.
Ci - Current loop integral	The integral of the current error is multiplied by this value. Integral gain reduces the current error to zero over time. It controls the DC accuracy of the loop, or the flatness of the top of a square wave signal. The error integral is the accumulated sum of the current error value over time.

### 12.1.7 Current Loop Output

The output of the current loop is a command that sets the duty cycle of the PWM output stage of the amplifier.

## 12.2 Velocity Loop Setup and Tuning

Initial velocity loop proportional gain (**Vp**) and velocity loop integral gain (**Vi**) values can be calculated with [Calculate](#).

Click the V Loop button  on the Main screen (contents vary with model and configuration):

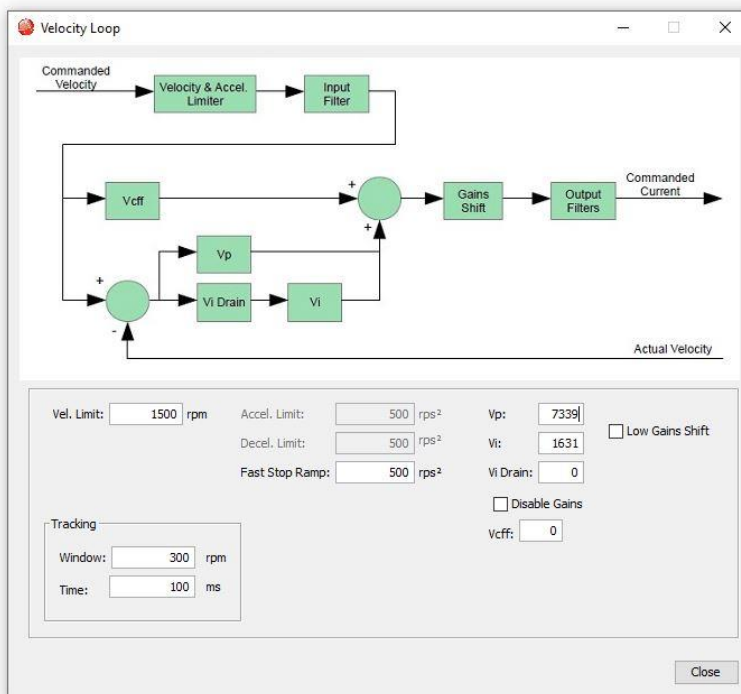

Parameter	Description
Velocity Limit	Top speed limit. Max value may depend upon the back EMF & the Encoder value. Min value: 0.

## Controls Loops

Acceleration Limit	Maximum acceleration rate. Max value may depend upon load, inertia, & peak current. Min value: 1. (Does not apply in position mode.)
Deceleration Limit	Maximum deceleration rate. Max value may depend upon load, inertia, & peak current. Min value: 1. (Does not apply in position mode.)
Tracking Window	See <a href="#">Position and Velocity Tracking Windows</a>
Tracking Time	
Vp	Velocity loop proportional gain. Range: 0 to 32,767.
Vi	Velocity loop integral gain. Range: 0 to 32,767.
Fast Stop Ramp	Deceleration rate used by the velocity loop when the amplifier is hardware disabled. Range: 0 to 100,000,000. Default: velocity loop Decel. Limit value.
Low Gains Shift	Increases the resolution of the units used to express Vp and Vi, providing more precise tuning. For more information, see <a href="#">Velocity Gains Shift</a> .
Hi Gains Shift	Decreases the resolution of the units used to express Vp and Vi, providing more precise tuning. For more information, see <a href="#">Velocity Gains Shift</a> .
Vi Drain (integral bleed)	Vi drain modifies the effect of velocity loop integral gain. The higher the Vi Drain value, the faster the integral sum is lowered. Range: 0 to 32,000. Default: 0.
Vcff	Velocity loop command feed forward. The input command to the velocity loop (after limiting) is scaled by this value and added to the output of the velocity loop.

## Manually Tune the Velocity Loop

**NOTE:** During tuning, observe any warnings that appear to the left of the trace.

1. Click the Scope Tool .

2. Choose **Velocity** from the Function Generator Apply To: drop list.



3. On the Settings tab, make sure **Auto Setup** is selected. Auto Setup automatically sets the following parameters:

<b>Function Generator Tab</b>	
Function	Square Wave
Amplitude	10% of maximum velocity value
Frequency	5 Hz
<b>Settings Tab</b>	
Channel 1	Limited velocity (green)
Channel 2	Actual Motor Velocity (white)

4. Verify that the amplitude value  is not excessive for the motor.

5. Click Start .

6. On the Gains tab, adjust velocity loop proportional gain ( $V_p$ ):

- Set velocity loop integral gain ( $V_i$ ) to zero.
- Raise or lower proportional gain ( $V_p$ ) to obtain desired step response.

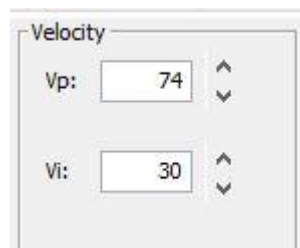

(Typically, little or no overshoot on a 5 Hz small, slow-speed square wave.)

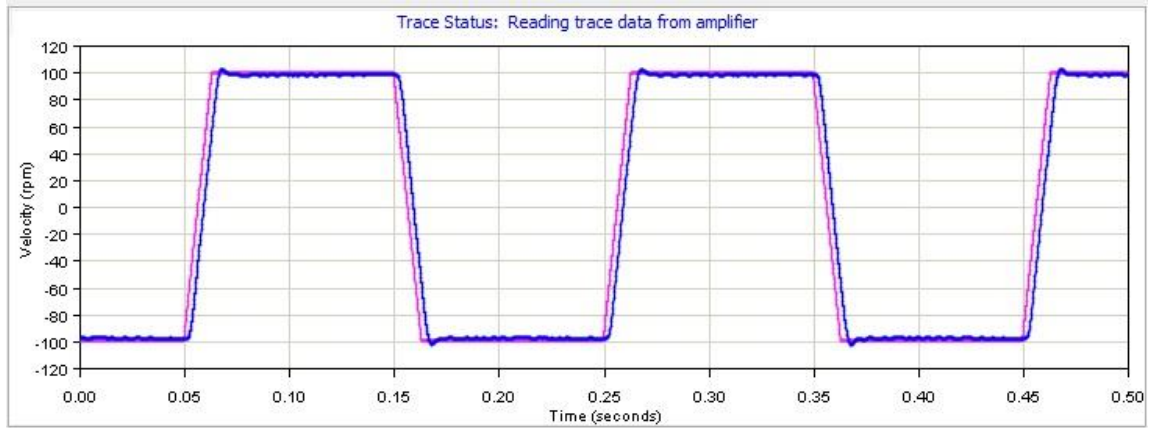

7. Adjust velocity loop integral gain ( $V_i$ ) until desired settling time is obtained.

**Note:** The image below shows a good example of a good velocity loop tuning, in which the wave forms for commanded and the actual velocity are very similar.

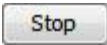

8. Click Stop  to stop the function generator.
9. On the Main screen, click **Save to Flash**  to avoid losing the changes.

## 12.3 Notes on the Velocity Mode and Velocity Loop

### 12.3.1 Velocity Loop Diagram

As shown below, the velocity loop limiting stage accepts a velocity command, applies limits, and passes a limited velocity command to the input filter. The filter then passes a velocity command to the summing junction. The summing junction subtracts the actual velocity, represented by the feedback signal, and produces an error signal. (The velocity loop feedback signal is always from the motor feedback device even when an additional encoder is attached to the load.) The error signal is then processed using the integral and proportional gains to produce a current command. Programmable digital filters are provided on both the input and output command signals.

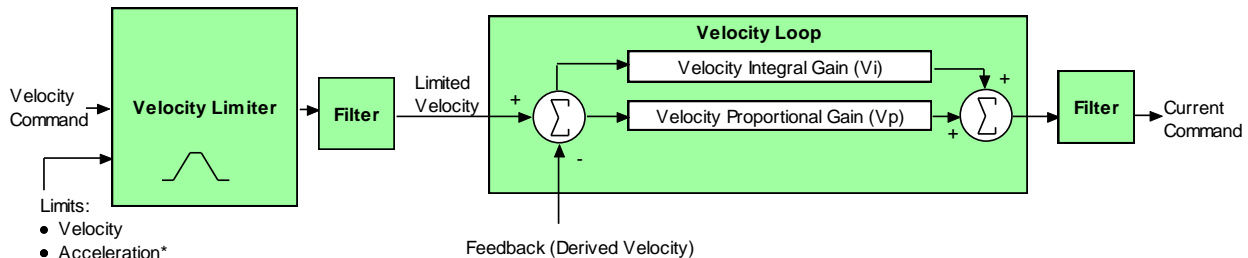

- Limits:
- Velocity
  - Acceleration\*
  - Deceleration\*
  - Emergency Stop Deceleration\*
- \*Not used when velocity loop is controlled by position loop. See "Velocity Loop Limits" for details.

### 12.3.2 Inputs

In velocity mode, the velocity command comes from one of the following:

- The amplifier's analog or PWM inputs.
- A CANopen network via the amplifier's CAN interface.
- A Copley Virtual Motion (CVM) control program.
- The amplifier's internal function generator.

In position mode, the velocity command is generated by the position loop.

### 12.3.3 Velocity Loop Limits

The velocity command is limited based on the following set of parameters designed to protect the motor and/or the mechanical system.

<b>Limiter</b>	<b>Description</b>
Velocity Limit	Sets the maximum velocity command input to the velocity loop.
Acceleration Limit	Limits the maximum acceleration rate of the commanded velocity input to the velocity loop. This limit is used in velocity mode only. In position mode, the trajectory generator handles acceleration limiting.
Deceleration Limit	Limits the maximum deceleration rate of the commanded velocity input to the velocity loop. This limit is used in velocity mode only. In position mode, the trajectory generator handles deceleration limiting.
Fast Stop Ramp	Specifies the deceleration rate used by the velocity loop when the amplifier is hardware disabled. (Fast stop ramp is not used when amplifier is software disabled.) If the brake output is active, the fast stop ramp is used to decelerate the motor before applying the brake.  Note that Fast Stop Ramp is used only in velocity mode. In position mode, the trajectory generator handles controlled stopping of the motor. There is one exception: if a non-latched following error occurs in position mode, then the amplifier drops into velocity mode and the Fast Stop Ramp is used.

**12.3.4 Diagram: Effects of Limits on Velocity Command**

The following diagram illustrates the effects of the velocity loop limits.

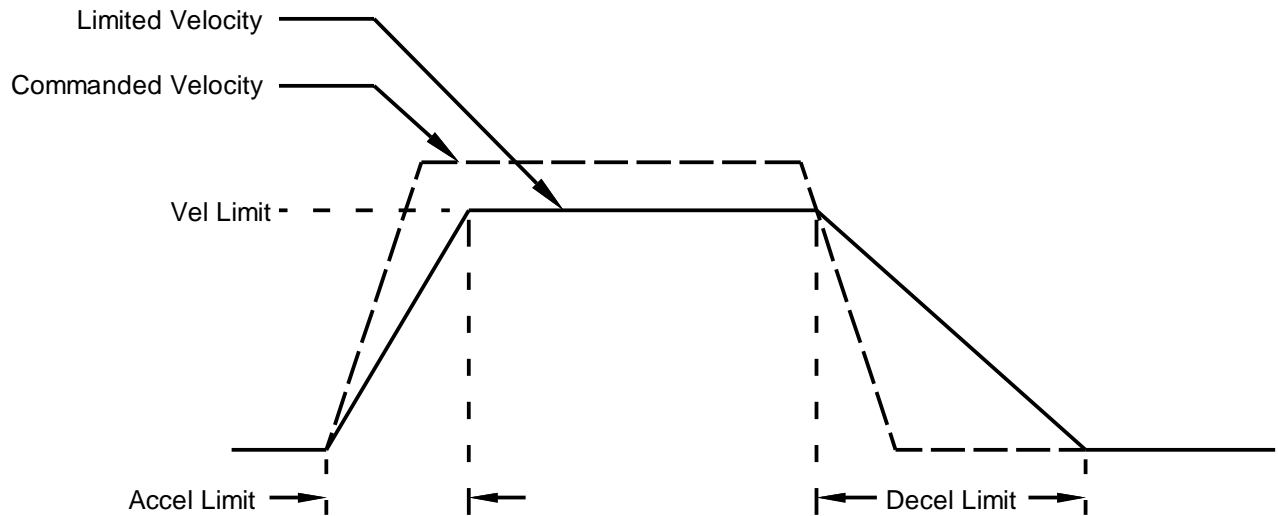

**12.3.5 Velocity Loop Gains**

The velocity loop uses these gains:

<b>Gain</b>	<b>Description</b>
Vp - Velocity loop proportional	The velocity error (the difference between the actual and the limited commanded velocity) is multiplied by this gain. The primary effect of this gain is to increase bandwidth (or decrease the step-response time) as the gain is increased.
Vi - Velocity loop integral	The integral of the velocity error is multiplied by this value. Integral gain reduces the velocity error to zero over time. It controls the DC accuracy of the loop, or the flatness of the top of a square wave signal. The error integral is the accumulated sum of the velocity error value over time.

### 12.3.6 Velocity Gains Shift

The Velocity Gains Shift feature adjusts the resolution of the units used to express  $V_p$  and  $V_i$ , providing more precise tuning. If the non-scaled value of  $V_p$  or  $V_i$  is 64 or less, the Low Gains Shift option is available to increase the gains adjustment resolution. (Such low values are likely to be called for when tuning a linear motor with an encoder resolution finer than a micrometer.) If the non-scaled value of  $V_p$  or  $V_i$  is 24001 or higher, the High Gains Shift option is available to decrease the gains adjustment resolution.

### 12.3.7 Velocity Loop Filters

See [Standard Filter Types](#).

### 12.3.8 Velocity Loop Outputs

The output of the velocity loop is a current command used as the input to the current loop.

### 12.3.9 Proper Tracking Over Time

As described earlier, position error is the difference between the limited position output of the trajectory generator and the actual position. Velocity error is the difference between commanded and actual velocity.

When the position or velocity error exceeds the programmed tracking window value, a status word bit is set. The bit is not reset until the error remains within the tracking window for the programmed tracking time.

### 12.3.10 Velocity Tracking Illustration

The following diagram illustrates the use of tracking window and time settings in velocity mode.

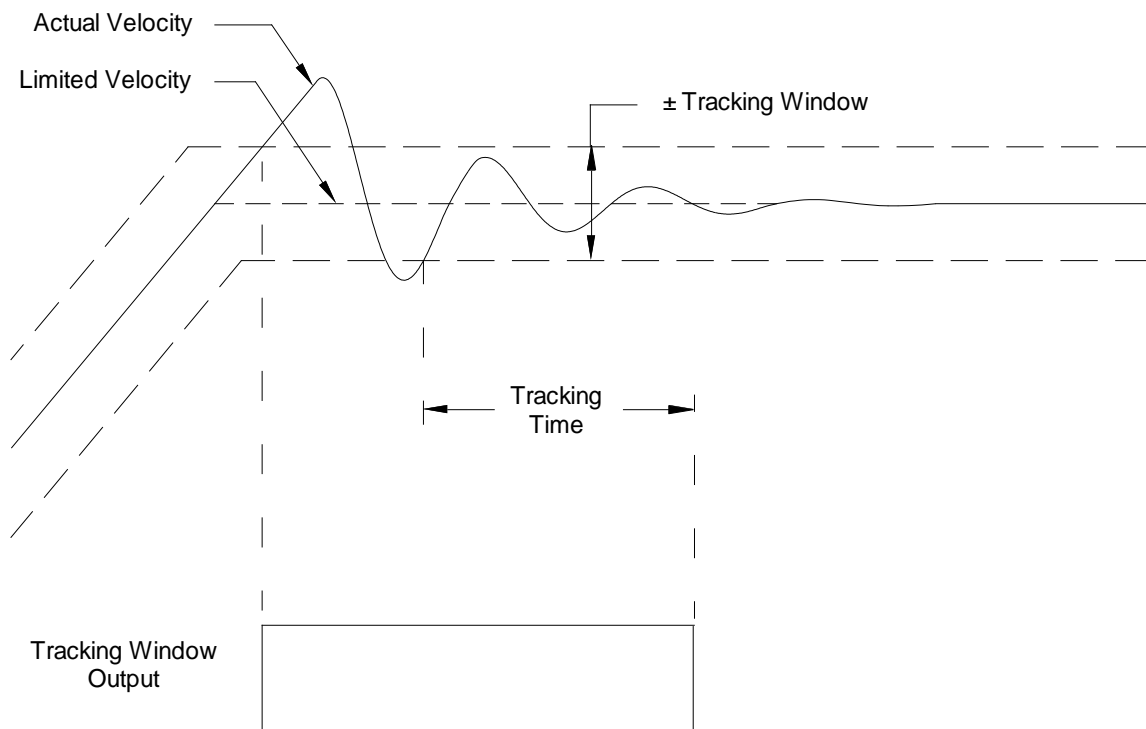



## 12.4 Position Loop Setup and Tuning

Initial position loop proportional gain (Pp), velocity feed forward (Vff), and acceleration feed forward (Aff) values can be calculated with [Calculate](#).

Click the P Loop button  on the Main screen.

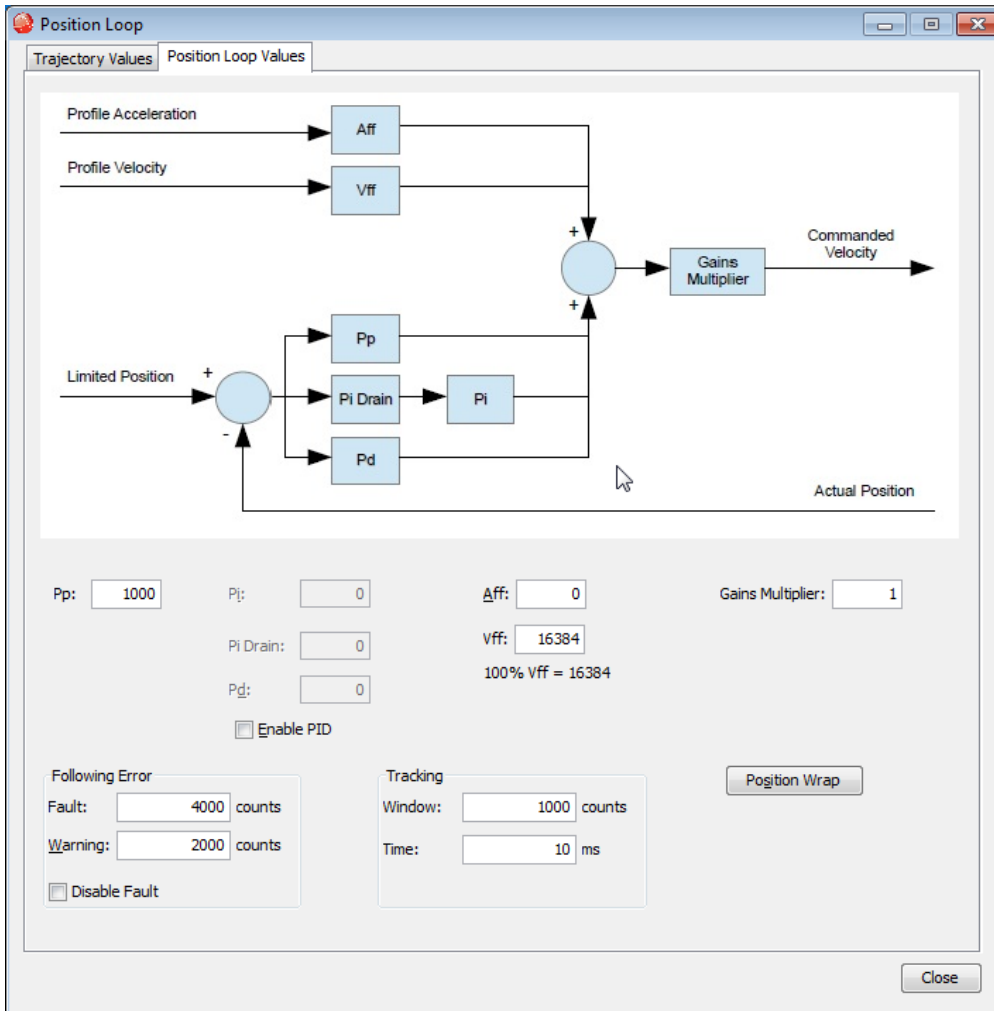

Parameter	Description
Aff	Acceleration feed forward. Range: 0 to 32,767. See <a href="#">Trajectory Limits</a>
Vff	Velocity feed forward. Range: 0 to 32,767. 100% Vff: 16,384. <a href="#">Trajectory Limits</a>
Pp	Position loop proportional gain. Range: 0 to 32,767. See <a href="#">Trajectory Limits</a>
Gains Multiplier	Position loop output is multiplied by this value before going to the velocity loop. In dual encoder systems, the multiplier's initial value is calculated based on the ratio of motor encoder turns to position encoder turns.
Following Error Fault	The level (in encoder counts) at which the following error produces a fault, which stops the servo loop. We recommend raising the fault level before tuning the loop. See <a href="#">Following Error Faults</a>

## Controls Loops

Following Error Warning	The level (in counts) at which the following error produces a warning (without stopping the loop). See <a href="#">Following Error Warnings</a>
Disable Fault	Stops following error from faulting. See <a href="#">Following Error Faults</a>
Tracking Window	Width of tracking window in counts. See <a href="#">Position and Velocity Tracking Windows</a>
Tracking Time	Position must remain in the tracking window for this amount of time to be considered tracking. See <a href="#">Position and Velocity Tracking Windows</a>
Pi	Position loop integral gain
Pd	Position loop derivative gain
Pi Drain	Position loop integral drain
Enable PID	Enables the PID parameters

Click the Position Wrap button

Position Wrap

Change/verify the position wrap parameters as needed. Set both values to zero to disable position wrapping. Note that the changes do not take effect until **OK** is pressed. For more information about this feature, see [Position Wrap](#).

Parameter	Description
Motor Position Wrap	Position at which the actual motor position count returns to zero. In a single feedback system, it also applies to the actual load position.
Load Position Wrap	Position at which the actual load position count returns to zero in dual feedback systems. If the position encoder is set to passive mode, this value applies to the passive encoder position.

## Controls Loops

Click on the **Trajectory Values** tab.

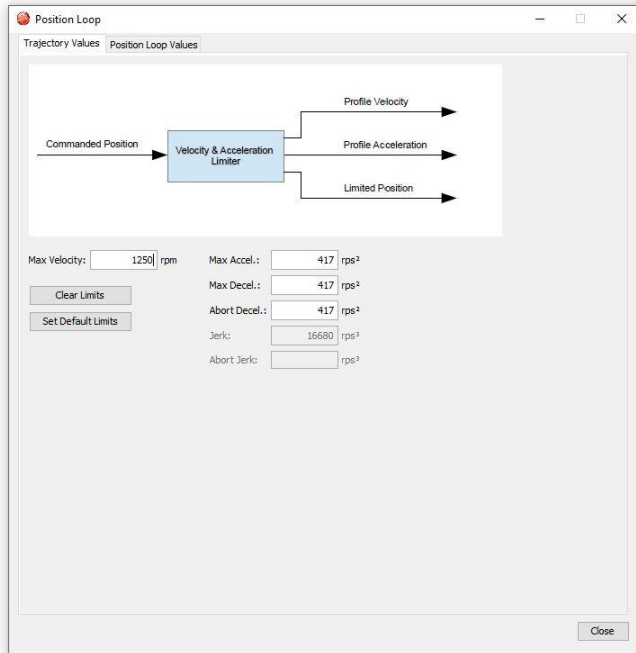



12.4.1 Parameter	12.4.2 Description
Max Velocity	Maximum trajectory velocity. Max value may depend upon the back EMF and the Max feedback count. Min:0. Default: 0.25 x motor velocity limit.
Max Accel	Maximum trajectory acceleration. Max value may depend upon the load inertia and peak current. Min:0. Default: 0.5 x velocity loop Accel. Limit value.
Max Decel	Maximum trajectory deceleration. Max value may depend upon the load inertia and peak current. Min:0 (disables limit). Default: 0.5 x velocity loop Accel. Limit value.
Abort Decel	Deceleration rate used by the trajectory generator when motion is aborted. Min:0. Default: 0.5 x velocity loop Accel. Limit value.
Jerk	Rate of change of acceleration. The value of jerk set during the calculate procedure produces an S-Curve whose maximum slope is equal to the trajectory profile slope. This value will produce a maximum acceleration that is not more than the initial default value of acceleration. Small values will produce less jerking but will take longer to complete move. Large values will produce more jerking and a more trapezoidal profile but will complete the move faster.
Note that setting limits to zero disables the trajectory generator so that the command input is not limited by the generator. Velocity is only limited by the Velocity Limit set in the Velocity Loop.	

## Manually Tune the Position Loop

**NOTE:** During tuning, observe warnings that appear to the left of the trace.

1. Click the **Scope Tool** .
2. Select the **Profile** tab .
3. On the Settings tab, make sure **Auto Setup**  **Auto Setup** is selected. Auto Setup automatically sets the following parameters:

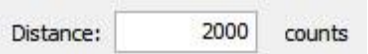
<b>Profile Tab</b>	
Move	Relative
Type	Trap
Distance	2000 counts
Reverse and repeat	Not selected
<b>Settings Tab</b>	
Channel 1	Profile velocity (green)
Channel 2	Following error (white)

4. If the Auto Setup default profile distance is not appropriate, enter an appropriate short distance .
5. Click **Start** . The Profile Generator executes a short move.
 

NOTES:

  - The profile may not reach constant velocity during a short move.
  - If a following error occurs, open the Control Panel and click Clear Faults.
6. Set up a trapezoidal profile by setting the trajectory limits and distance. See table

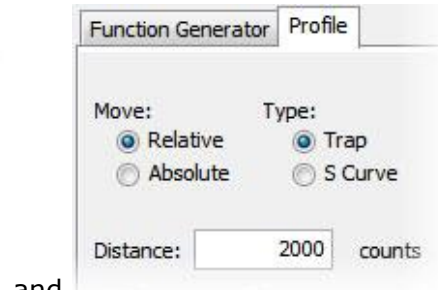
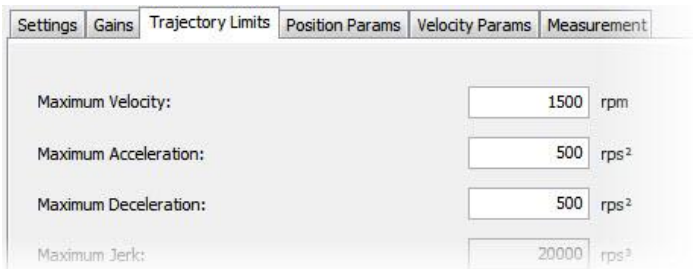

and

<b>Trajectory Limits Tab</b>	
Maximum Velocity	Set values typical of those expected to be used in the application.
Maximum Acceleration	
Maximum Deceleration	
<b>Profile Tab</b>	
Distance	Set the move distance to produce a complete trajectory profile. Be sure that this distance does not exceed mechanical limits of the system.
Move	Relative
Type	Trap

7. Adjust position proportional gain (Pp) to minimize following error:

- On the Gains tab, set velocity feed forward (Vff) and acceleration feed forward (Aff) to zero.
- On the Profile tab, click **Start**. On the Gains tab, adjust position loop proportional gain (Pp) until best result is obtained.
- Click **Start** after each adjustment to test on a new profile move.

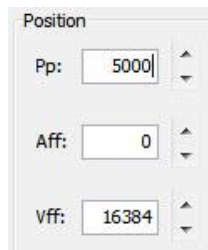

**NOTE:**

1. Too much position loop proportional gain (Pp) might cause oscillation.
2. If a following error occurs, open the Control Panel and click **Clear Faults**.

8. Adjust velocity feed forward (Vff):

- Velocity feed forward (Vff) reduces following error in the constant velocity portion of the profile. Often, a velocity feed forward (Vff) value of 16384 (100%) provides best results.
- Click in the Vff field and adjust the value.
- Click **Start** after each adjustment to test on a new profile move.

9. Adjust acceleration feed forward (Aff):

- Acceleration feed forward (Aff) reduces following error during profile acceleration and deceleration.
- Click in the Aff field and adjust the value.
- Click **Start** after each adjustment to test on a new profile move.

## Controls Loops

### NOTE:

1) If, after tuning the position loop, the motor makes a low frequency audible noise while enabled but not moving, the velocity loop gains ( $V_p$  and  $V_i$ ) may be lowered to reduce the noise. If the gain values are set too low, the response to instantaneous rates of change might be reduced (i.e., slow correction to disturbances or transients).

2) If the amplifier is set up to run in position mode under analog input command, and the analog command signal produces too much noise at the motor after tuning, the Analog Command Filter or the Velocity Loop Command Filter may be used to reduce the noise further.

10. Tune to multiple sets of profiles representing typical moves that might be executed in the application. Starting with Step 6, repeat the process as needed.

**Note:** The image below shows a good example of a good position loop tuning.

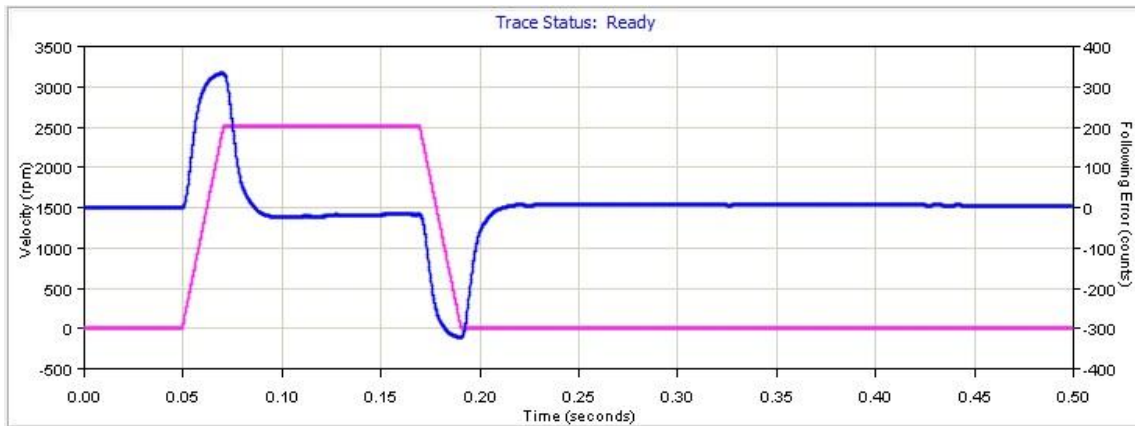

### 12.4.1 Test S-Curve Profile

If the amplifier will perform S-Curve profile moves, use this procedure to tune the level of jerk. (Jerk is the rate of change of acceleration. S-Curve moves reduce jerk to provide a smooth profile.) Run an S-Curve profile and adjust velocity, acceleration, deceleration, and jerk levels until the desired profile is obtained. For instance:

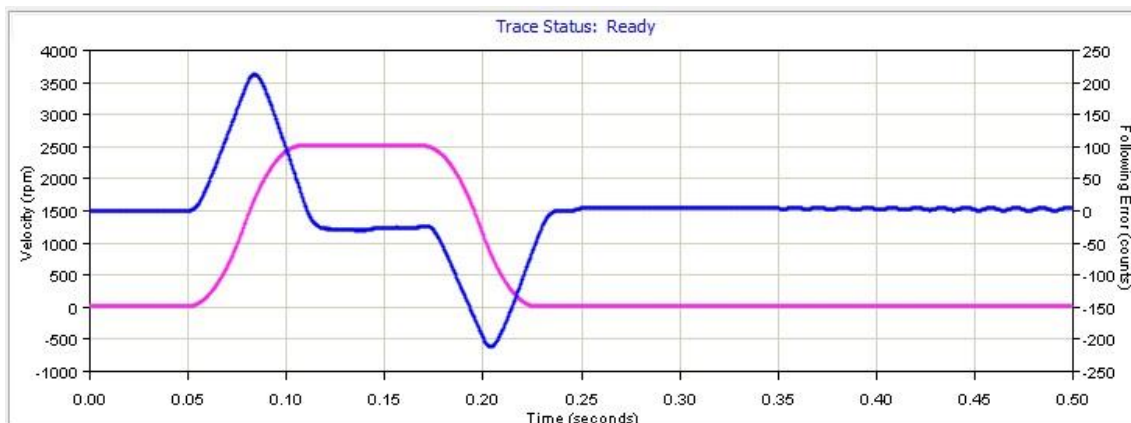

## Controls Loops

1. On the **Profile** tab, click the **S-Curve** button.

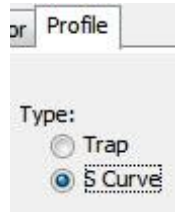

2. Set up an S Curve profile by adjusting the following parameters to represent a typical move under normal operation.

<b>Trajectory Limits Tab</b>	
Maximum Velocity	Maximum speed of the profile.
Maximum Acceleration/Deceleration	Maximum acceleration/deceleration of the profile. The deceleration is set to be the same as acceleration.
Maximum Jerk	The value of jerk set during the calculate procedure produces an S-Curve whose maximum slope is equal to the trajectory profile slope. This value will produce a maximum acceleration that is not more than the initial default value of acceleration. Small values will produce less jerking but will take longer to complete move. Large values will produce more jerking and a more trapezoidal profile but will complete the move faster.
<b>Profile Tab</b>	
Distance	Increase the move distance to produce a complete trajectory profile. Use an acceptable value the does not exceed mechanical limits of the system.
Move	Relative
Type	S-Curve

3. Click **Start**.
4. Try multiple sets of profiles representing typical moves that might be executed in the application. Starting with Step 2, repeat the process as needed.

## 12.5 Notes on the Position Mode and Position Loop

### 12.5.1 Position Loop Diagram

The amplifier receives position commands from the digital or analog command inputs, over the CAN interface or serial bus, or from the CVM Control Program. When using digital or analog inputs, the amplifier's internal trajectory generator calculates a trapezoidal motion profile based on trajectory limit parameters. When using the CAN bus, serial bus, or CVM Control Program, a trapezoidal or S-curve profile can be programmed. The trajectory generator updates the calculated profile in real time as position commands are received.

The output of the generator is an instantaneous position command (limited position). In addition, values for the instantaneous profile velocity and acceleration are generated. These signals, along with the actual position feedback, are processed by the position loop to generate a velocity command.

To bypass the trajectory generator while in digital or analog position modes, set the maximum acceleration to zero. The only limits in effect will now be the velocity loop velocity limit and the current limits. (Note that leaving the maximum acceleration set to zero will prevent other position modes from operating correctly.)

The following diagram summarizes the position loop.

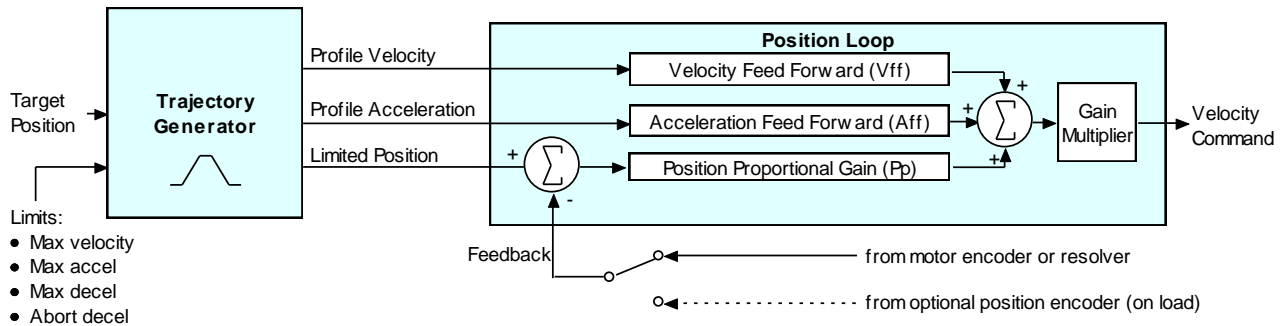

### 12.5.2 Trajectory Limits

In position mode, the trajectory generator applies these limits to generate the profile.

Limiter	Description
Maximum Velocity	Limits the maximum speed of the profile.
Maximum Acceleration	Limits the maximum acceleration rate of the profile.
Maximum Deceleration	Limits the maximum deceleration rate of the profile.
Abort Deceleration	Specifies the deceleration rate used by the trajectory generator when motion is aborted.

### 12.5.3 Position Loop Inputs From the Trajectory Generator

The position loop receives the following inputs from the trajectory generator.

Input	Description
Profile Velocity	The instantaneous velocity value of the profile. Used to calculate the velocity feed forward value.
Profile Acceleration	The instantaneous acceleration/deceleration value of the profile. Used to calculate the acceleration feed forward value.
Limited Position	The instantaneous commanded position of the profile. Used with the actual position feedback to generate a position error.



### 12.5.4 Position Loop Gains

The following gains are used by the position loop to calculate the velocity command:

Gain	Description
Pp - Position loop proportional	The loop calculates the position error as the difference between the actual and limited position values. This error in turn is multiplied by the proportional gain value. The primary effect of this gain is to reduce the following error.
Vff - Velocity feed forward	The value of the profile velocity is multiplied by this value. The primary effect of this gain is to decrease following error during constant velocity.
Aff - Acceleration feed forward	The value of the profile acceleration is multiplied by this value. The primary effect of this gain is to decrease following error during acceleration and deceleration.
Gain Multiplier	The output of the position loop is multiplied by this value before being passed to the velocity loop.

### 12.5.5 Position Loop Feedback

Some Copley Controls amplifiers feature dual-sensor position loop feedback, configured as follows:

- Single sensor. Position loop feedback comes from the encoder or resolver on the motor.
- Dual sensor. Position loop feedback comes from the encoder attached to the load.

(Note that in either case, velocity loop feedback comes from the motor encoder or resolver.)

### 12.5.6 Position Loop Output

The output of the position loop is a velocity command used as the input to the velocity loop.

### 12.5.7 Position Wrap

The position wrap feature causes the position reported by the amplifier to “wrap” back to zero at a user-defined value instead of continually increasing. Once set, the reported position will be between 0 and n-1 where n is the user entered wrap value. This feature is most useful for rotary loads that continually turn in one direction and only the position within a revolution is of interest to the user.

Relative moves with the wrap value set will move the relative distance called for. Example; if the wrap value is set to 1000 and a relative move of 2500 is commanded, the axis will turn 2 ½ revolutions.

Absolute moves will move the shortest distance to arrive at the programmed position. This could be in the positive or negative direction. Moves programmed to a point greater than the wrap value will cause an error.

### 12.5.8 Following Error Faults

When the position error reaches the programmed fault threshold, the amplifier immediately faults. (The following error fault can be disabled at the configure faults tab on the main screen.)

### 12.5.9 Following Error Warnings

When the position error reaches the programmed warning threshold, the amplifier immediately sets the following error warning bit in the status word. This bit can be read over the CAN network. It can also be used to activate a digital output.

### **12.5.10 Position and Velocity Tracking Windows**

When the position error exceeds the programmed tracking window value, a status word bit is set. The bit is not reset until the position error remains within the tracking window for the programmed tracking time.

A similar method is used to handle velocity errors.

### **12.5.11 Following Error Fault Details**

#### **12.5.11.1 Position Error Reaches Fault Level**

As described earlier, position error is the difference between the limited position output of the trajectory generator and the actual position. When position error reaches the programmed Following Error Fault level, the amplifier faults (unless the following error fault is disabled.) As with a warning, a status bit is set. In addition, the fault is recorded in the error log. See [Error Log](#).

Additional responses and considerations depend on whether the fault is non-latched or latched, as described below.

#### **12.5.11.2 Amplifier Response to Non-Latched Following Error Fault**

When a non-latched following error fault occurs, the amplifier drops into velocity mode and applies the Fast Stop Ramp deceleration rate to bring the motor to a halt. The amplifier PWM output stage remains enabled, and the amplifier holds the velocity at zero, using the velocity loop.

#### **12.5.11.3 Resuming Operations After a Non-Latched Following Error Fault**

The clearing of a non-latched following error depends on the amplifier's mode of operation. Issuing a new trajectory command over the CAN bus or the ASCII interface will clear the fault and return the amplifier to normal operating condition.

If the amplifier is receiving position commands from the digital or differential inputs, then the amplifier must be disabled and then re-enabled using the amplifier's enable input or through software commands. After re-enabling, the amplifier will operate normally.

#### **12.5.11.4 Amplifier Response to a Latched Following Error Fault**

When a latched following error fault occurs, the amplifier disables the output PWM stage without first attempting to apply a deceleration rate.

#### **12.5.11.5 Resuming Operations After a Latched Following Error Fault**

A latched following error fault can be cleared using the steps used to clear other latched faults:

- Power-cycle the amplifier
- Cycle (disable and then enable) an enable input that is configured as Enable with Clear Faults or Enable with Reset
- Access the CME 2 Control Panel and press **Clear Faults** or **Reset**
- Clear the fault over the CANopen network or serial bus

## 12.6 Motor Characterization

This feature is only available for use with linear motors.

If motor specification cannot be obtained from the motor manufacturer due to obscolnece or lack of good support, then the motor ratings label can be used.

Motor ratings label



**DANGER**

**Make sure motor is mounted firmly and verify accuracy and completeness of motor data.**

**Failure to heed this warning can cause equipment damage, injury, or death.**

## 13 STEPPER TUNING

### 13.1 Stepper Motor Support

CME supports Copley's stepper amplifier family. Stepper amplifiers can run in stepper mode or servo mode.

This chapter describes controls that can be used to fine-tune a stepper amplifier in stepper mode: Encoder Correction and Detent Compensation Gain. It also describes the screen used in stepper mode to set Position Limits.

When a stepper amplifier is used in servo mode, it operates as a true, closed loop, servo amplifier controlling a stepper motor. After putting the stepper amplifier into servo mode, set it up and tune it just as you would a servo amplifier.

### 13.2 Position Limits (Stepper Amplifier)

Perform the following steps to set position limits for a stepper amplifier connected to an encoder with Encoder Correction enabled (not operating in Servo mode).

Click the Pos Limits button  on the Main screen.

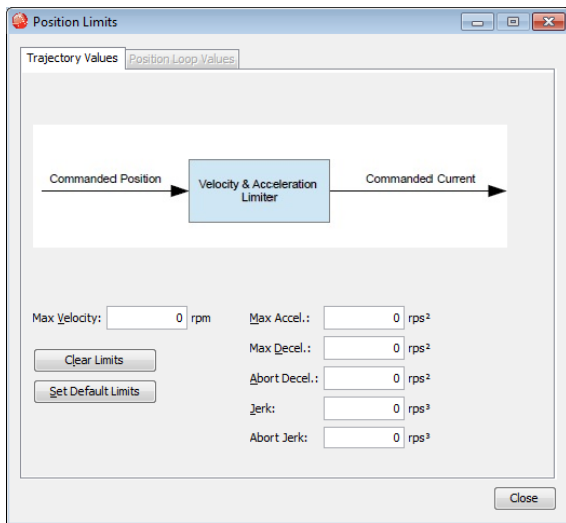

## Stepper Tuning

<b>Parameter</b>	<b>Description</b>
Max Velocity	Maximum trajectory velocity. Max value may depend upon the back EMF and the Max feedback count. Min:0. Default: 0.25 x motor velocity limit.
Max Accel	Maximum trajectory acceleration. Max value may depend upon the load inertia and peak current. Min:0. Default: 0.5 x velocity loop Accel. Limit value.
Max Decel	Maximum trajectory deceleration. Max value may depend upon the load inertia and peak current. Min:0 (disables limit). Default: 0.5 x velocity loop Accel. Limit value.
Abort Decel	Deceleration rate used by the trajectory generator when motion is aborted. Min:0. Default: 0.5 x velocity loop Accel. Limit value.
Jerk	Rate of change of acceleration. The value of jerk set during the calculate procedure produces an S-Curve whose maximum slope is equal to the trajectory profile slope. This value will produce a maximum acceleration that is not more than the initial default value of acceleration. Small values will produce less jerking but will take longer to complete move. Large values will produce more jerking and a more trapezoidal profile but will complete the move faster.
Abort Jerk	The value of Jerk used when a move is aborted.
Note that setting limits to zero disables the trajectory generator so that the command input is not limited by the generator. Velocity is only limited by the Velocity Limit set in the Velocity Loop.	

### 13.3 Encoder Correction

For a stepper motor with an encoder, encoder correction may be used to compensate for lost microsteps. Normally, in an open loop micro stepping mode with an encoder, the total number of micro steps per revolution is set to the number of encoder counts per revolution. However, a following error can accumulate when micro steps are lost.

In encoder correction mode, when a commanded position is not equal to the actual position, indicated by encoder counts, the following error is multiplied by the Encoder Corrections proportional gain (ECp), and micro steps are added to the open loop micro stepping loop.

If the error is large or the gain is high, micro steps are added at a higher rate, up to the Max step rate limit. If the ECp gain is too high, the loop will become unstable and corrections will not reduce the position error. The position error will not be reduced if the Max step rate is outside of the motors stepping ability. If steps are lost during a move, encoder corrections are made during the move, but will tend to accumulate during the trajectory profile and become resolved by the end of the move.

## Stepper Tuning

1. Click to open the Encoder Correction  screen.

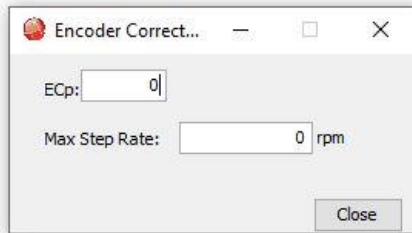

2. Set the Encoder Correction parameters:

<b>Parameter</b>	<b>Description</b>
ECp	Proportional gain used to compensate for lost microsteps. Default: 0.
Max Step Rate	Maximum velocity allowed while using ECp to correct position errors. Excessive velocity can result in more lost microsteps. Default: 0.

### **Test Encoder Correction**

While holding position, introduce a position error by rotating the motor shaft by hand.

NOTE: Reduce the holding current slightly if unable to rotate shaft.

The ECp will act on the error and the motor will settle into position slower than a servo motor but in a reasonable amount of time.

## **13.4 Detent Compensation Gain**

Stepper motors are subject to torque detent that can cause undesired velocity fluctuation between full steps of motion. The Detent gain feature can compensate for this detent.

## Stepper Tuning

1. Click **Detent**  to open the stepper amplifier Advanced Tuning screen.

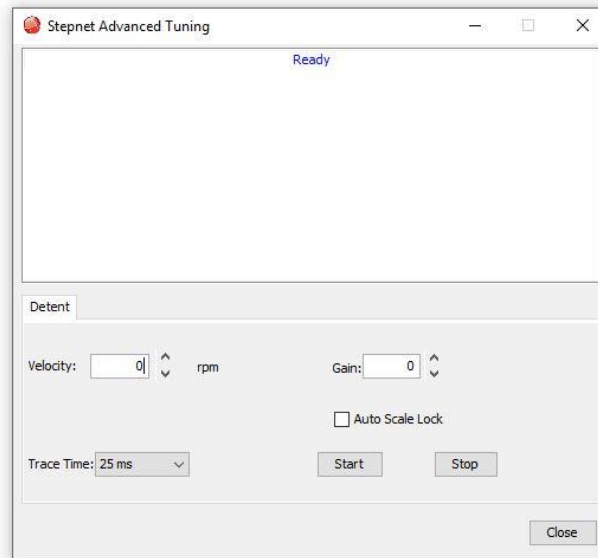

<b>Setting</b>	<b>Description</b>
Velocity	Tuning velocity. Default: 0.
Trace Time	Length of trace interval to be shown on screen. Default: 25 ms.
Gain (Detent Gain)	The Stepper Detent Gain value. Default: 0.
Auto Scale Lock	When selected, prevents trace display from rescaling during tuning.

2. Click **Start** to begin the tuning.
3. Adjust **Velocity** from 0 until the mechanical system begins to resonate. (Using a 1.8 degree step motor with 200 full steps, this will typically occur at a velocity of 40-70 rpm.)
4. Adjust **Gain** until the resonance increases, and then back it down until the resonance is minimized.
5. Click **Stop** to stop the tuning.
6. Click **Close** to close the window.
7. On the CME Main screen, click **Save to Flash** .

# 14 HOMING

## 14.1 Overview

The Homing screen allows homing to be configured and tested. Changes made to this screen get saved to amplifier RAM. On amplifiers configured for Absolute encoders, calibration can be performed.



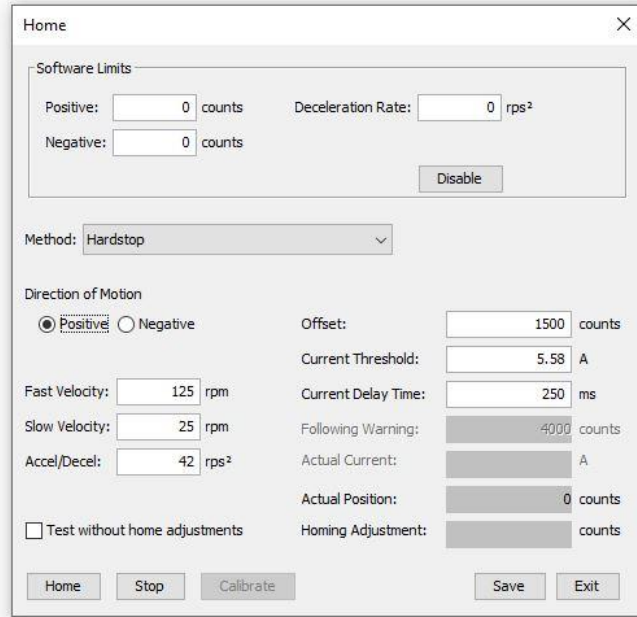

Click the Home button  on the Main screen to open the Home screen



Parameter	Description
Software limits: Positive	Position of user-defined travel limits that take effect after homing operation.
Software limits: Negative	
Software limits: Deceleration Rate	Deceleration rate used to stop a motor when approaching a software limit.
Software limits: Disable	Disables the use of software limits by setting both limits to zero.
Method	Homing method. See <a href="#">Homing Method Descriptions</a>
Direction of Motion	Initial direction of motion for the homing method (Pos or Neg).
Fast Velocity	The velocity used to find a limit or home switch. Also used when moving to an offset position, or a resolver or Servo Tube index position.
Slow Velocity	The velocity used to find a switch edge, incremental or analog encoder index pulse, or hard stop.
Accel/Decel	The acceleration and deceleration rate used during homing.
Offset	Execute a move of this distance after the reference is found. Set actual position to 0 and call the new position home.

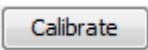
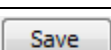

## Homing

Current Threshold	Hard stop home is reached when the amplifier outputs the homing Current Limit continuously for the time specified in the Delay Time.
Current Delay Time	
Following Warning	Shows the programmed following warning level.
Actual Current	Shows actual current being applied to windings during homing.
Actual Position	Shows the actual position of the axis.
Homing Adjustment	Shows the Home offset measured after homing is performed.
Test without home adjustments	Selecting this option and pressing the Home Button tests the adjusted home position without making any changes to the saved home position. The resulting homing offset is reported in the Homing Adjustment text field.
	Starts the homing sequence using the settings shown on the screen.
	Stops the homing sequence.
	Starts the Calibration routine for absolute encoders. See <a href="#">Absolute Encoder Calibration</a>
	Saves the homing parameters to amplifier flash.
	Discards unsaved homing parameters, then closes the screen. The rules for discarding unsaved values are as follows: <ul style="list-style-type: none"> <li>• If the Save button was never clicked, all of the homing parameters will be reverted to the values at the time that the screen was opened.</li> <li>• If the Save button was clicked, then the homing parameters will be reverted to the values at the time of the last Save event.</li> </ul> Upon closing, any home sequence in progress will be aborted.

## 14.2 Absolute Encoder Calibration

When absolute encoders are used, the absolute encoder value that corresponds to the zero position in the machine's reference frame is saved to flash memory in the drive. This value is then added to the absolute encoder reading so that all position measurements are in absolute units in the machine's coordinate system. Movement of the motor to 'find' the machine's reference point is not necessary. This process is called calibration because it's done once when the machine and drive are commissioned together and does not need to be repeated until the encoder is changed, or adjustment of the machine-zero location is changed.

Note: This feature is only available on the Plus family of drives with a minimum firmware version of 2.00.

Calibration of an absolute encoder is a two-part process:

1. Mechanical Homing
2. Calibration

### 14.2.1 Mechanical Homing

Mechanical homing is the process of moving the motor to the position that is machine-zero. This is the location from which all dimensions are absolute in the machine's position reference frame.

## Homing

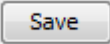
1. Enter the values of the appropriate homing parameters.
2. Click the Home button  to run the home sequence.
3. Repeat if necessary until the motor is positioned at machine zero.
4. Click the Save button .

### 14.2.2 Calibration

Calibrating the encoder involves saving the absolute position at machine-zero to the drive's flash. This value will be saved as a negative number and added to the absolute encoder positions thereafter by the firmware to convert them to machine absolute values. This value is stored in the Home Offset parameter. CME provides a single button-click operation to perform this calibration.

Click the Calibrate button  to initiate the calibration routine.

CME will perform the following sequence:

- Set the calibration bit of the Homing Configuration register.
- Initiate the homing sequence.

The drive will then perform the following sequence:

- Run the home sequence.
- Save the Home Offset in flash.
- Change the home method to Absolute Encoder Immediate Home.

The Homing Adjustment field on the Home screen will show the offset value saved in flash. Once the calibration is complete, the Calibrate button will be disabled until another home sequence is run by clicking the Home button. To remove the calibration, change the Home Method from Absolute Encoder Immediate Home to some other method, and run the home sequence.

# 15 CONTROL PANEL

## 15.1 Control Panel Overview

Click to open the Control Panel .

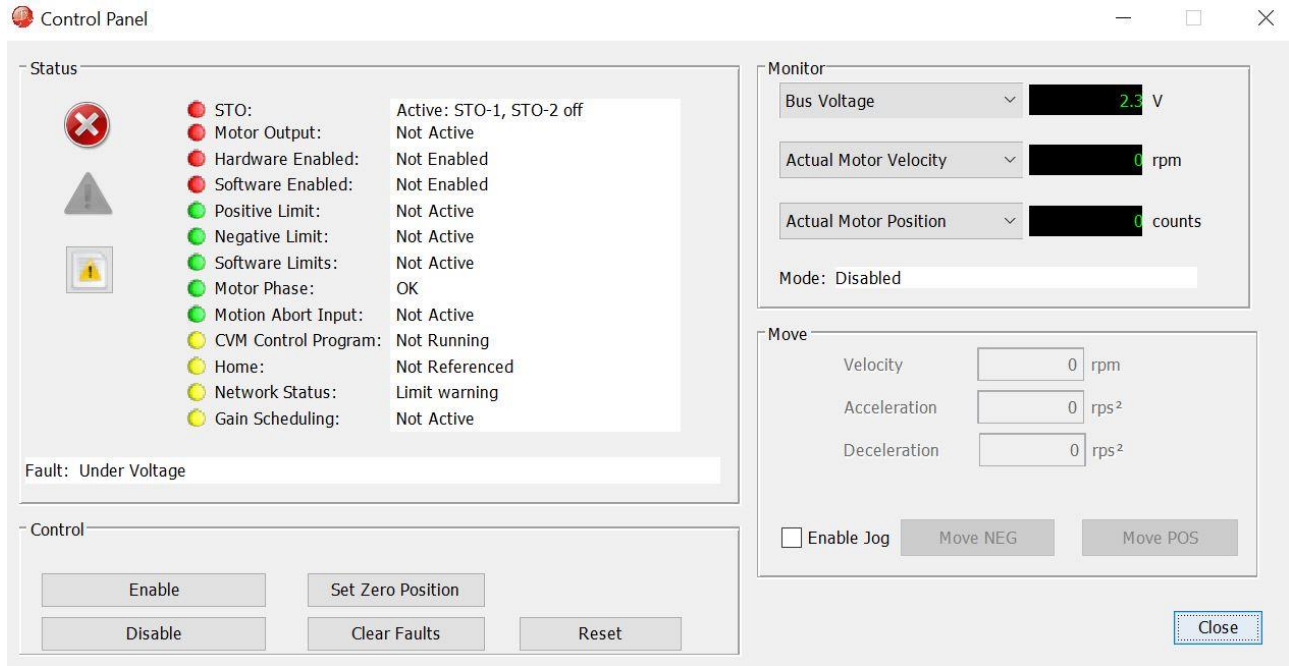



## 15.2 Status Indicators and Messages

The Status area includes status indicator lights (described below) and a message box. Any red lights indicate that motion will be inhibited.

Indicator	States/Description
STO	State of the safety circuit. Enabled or HI/LO disabled. On amplifiers with safety circuit.
Motor Output	State of the PWM output stage. Red if the output stage is inactive (disabled)
Hardware Enabled	State of the hardware enable input(s). Red if one or more enable inputs are inactive.
Software Enabled	State of the software enable. Red if the amplifier is disabled by software.
Positive Limit	State of the positive limit switch input. Red indicates an activated positive limit switch.
Negative Limit	State of the negative limit switch input. Red indicates an activated negative limit switch.
Software Limits	State of the software limits. Red indicates an activated software limit.
Motor Phase	Indicates a motor phasing error. Red indicates a motor phasing error exists.
Motion Abort Input	State of the programmed Motion Abort Input. Red indicates the input is active.

## Control Panel

CVM Control Program	Status of the CVM Control Program.
Home	Indicates whether the axis has successfully been referenced (homed).
Network Status	Status of the network communication. Yellow indicates warning limit reached. Red indicates bus error detected.
Gain Scheduling	Indicates whether <a href="#">Gain Scheduling</a> is active.
	Indicates that a fault is active. Check the status message box for a description of the most recent fault: <code>Fault: Under Voltage</code> . Check the Error Log for a full history of faults and warnings.
	Indicates that a warning is active. Check the status message box for a description of the most recent: <code>Warning: Pos Outside of Tracking Window</code> . Check the Error Log for a full history of faults and warnings.
Message Box	Displays status descriptions.

## 15.3 Control Panel Monitor

The Control Panel Monitor displays real-time values of selected variables.

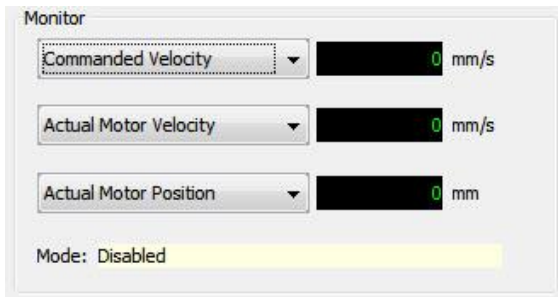

Monitor Variables		
Actual Current	Following Error	Passive Load Position
Actual Motor Velocity	Commanded Current	Limited Position
Actual Motor Position	Commanded Velocity	Analog Command
Actual Load Velocity	Commanded Position	Bus Voltage
Actual Load Position	Profile Velocity	Amplifier Temperature
Velocity Error	Profile Acceleration	Motor Phase Angle

**Mode:** Displays the amplifier's operating mode in RAM. In camming mode it also displays the active cam table number

## 15.4 Control Functions

The Control area of the screen provides functions related to overall amplifier control. The screen options vary with model and configuration.

## Control Panel

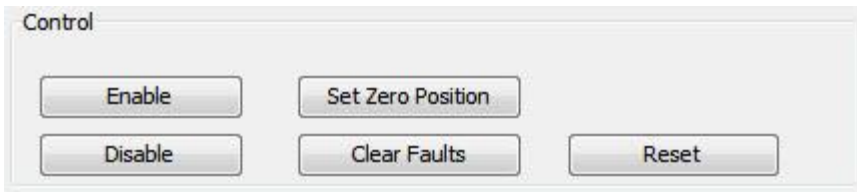

Control	Description
Enable	Click to software enable the amplifier.
Disable	Click to software disable the amplifier. This will also stop any CVM programs that are running.
Set Zero Position	Click to set the amplifier's actual position counter to zero.
Clear Faults	Click to clear all amplifier faults.
Reset	Click to reset the amplifier.



### WARNING

#### Risk of unexpected or uncontrolled motion.

Using the CME, Set Zero Position function while the amplifier is operating under external control could cause unexpected or uncontrolled motion.

**Failure to heed this warning can cause equipment damage.**

## 15.5 Jog Mode

Jog mode provides a simple means for moving/jogging the motor.

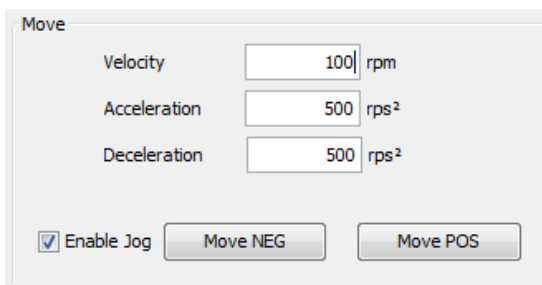

1. To put the amplifier in jog mode, select **Enable Jog**.
2. Set up a jog move by setting the following mode-specific parameters:

Mode	Parameter	Description
<b>Current</b>	Current	Current applied to the motor. Limited by current loop Continuous Current. Warning: Unloaded motors may, depending on torque setting, ramp up in speed very quickly.

## Control Panel

<b>Velocity</b>	Jog Speed	Velocity of the jog move. Limited by velocity loop Vel. Limit.
<b>Position</b>	Velocity	Velocity of the jog move. Limited by velocity loop Vel. Limit.
	Acceleration	Acceleration limit of the jog move.
	Deceleration	Deceleration limit of the jog move.

### 3. Command the move:

<b>Mode</b>	<b>Steps</b>
<b>Current</b>	Hold <b>Pos</b> to apply positive current to the motor or hold down <b>Neg</b> to apply negative current to the motor. Release the button to command zero current.
<b>Velocity</b>	Hold <b>Jog Pos</b> to command a forward velocity or hold down <b>Jog Neg</b> to command a negative velocity. Release the button to command zero velocity.
<b>Position</b>	Hold <b>Move Pos</b> to generate a forward move profile or hold <b>Move Neg</b> to generate a negative move profile. Release the button to stop movement. NOTE: Position mode jog is accomplished by continuously updating the commanded position. If a following error develops with Following Error Fault disabled, motion will not stop on button release. Instead, it stops when actual position = commanded position.

## 16 SCOPE

### 16.1 Overview

The Scope can be used to tune the amplifier, monitor performance, and perform diagnostics. Function Generator and Profile Generator can drive the motor without external control. Auto Set Up feature sets typical initial values for scope parameters.

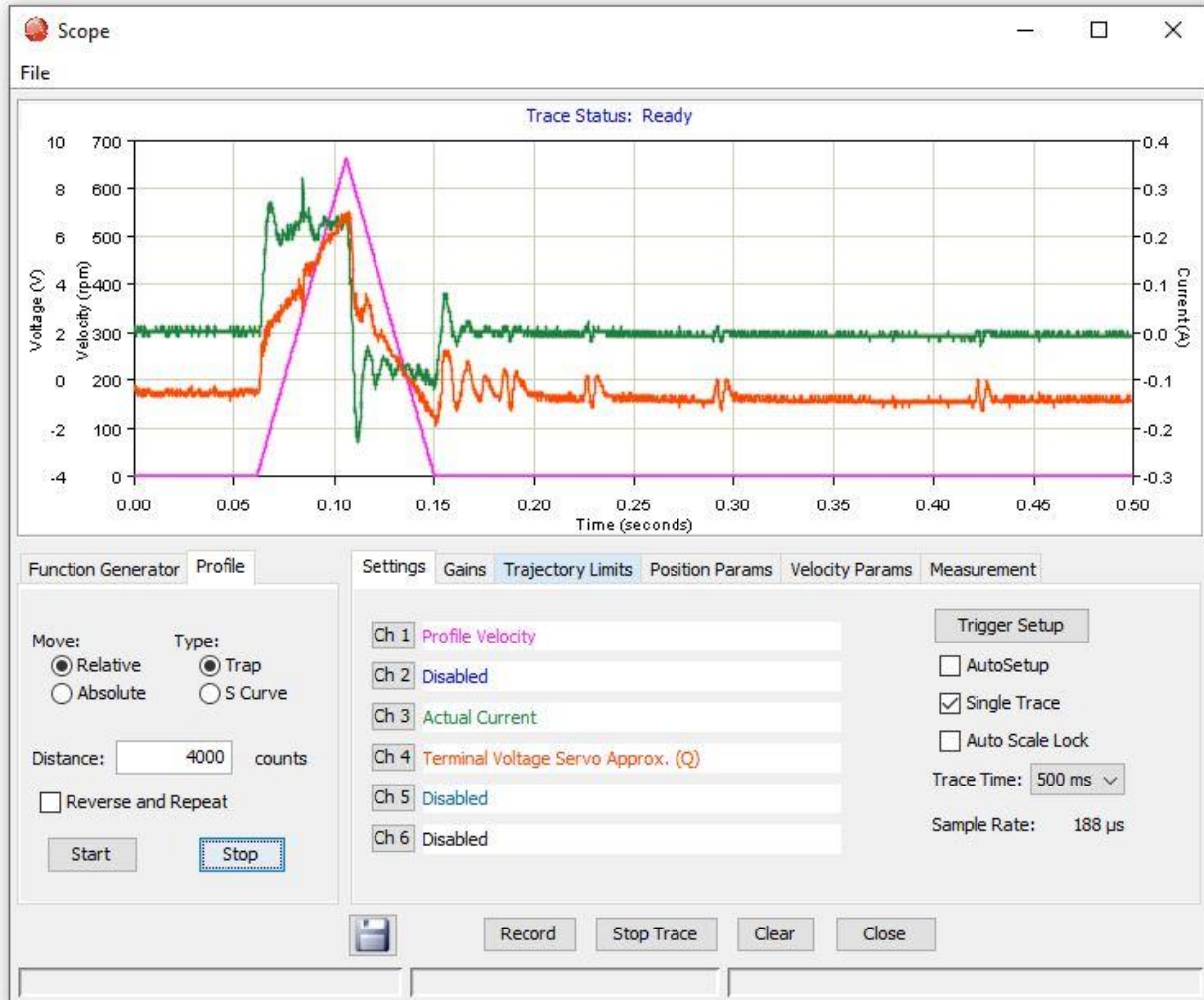

### 16.2 Menu, Display and Controls

#### 16.2.1 File Menu



The File menu contains the options to save/restore scope settings. This feature is useful for saving custom settings used for tests that are run frequently.

## Scope

File Menu	
Save Settings	Saves current scope settings to a file
Restore Settings	Restores settings from a file

### 16.2.2 Display

To access the Trace Display menu, Right-click in the trace display area

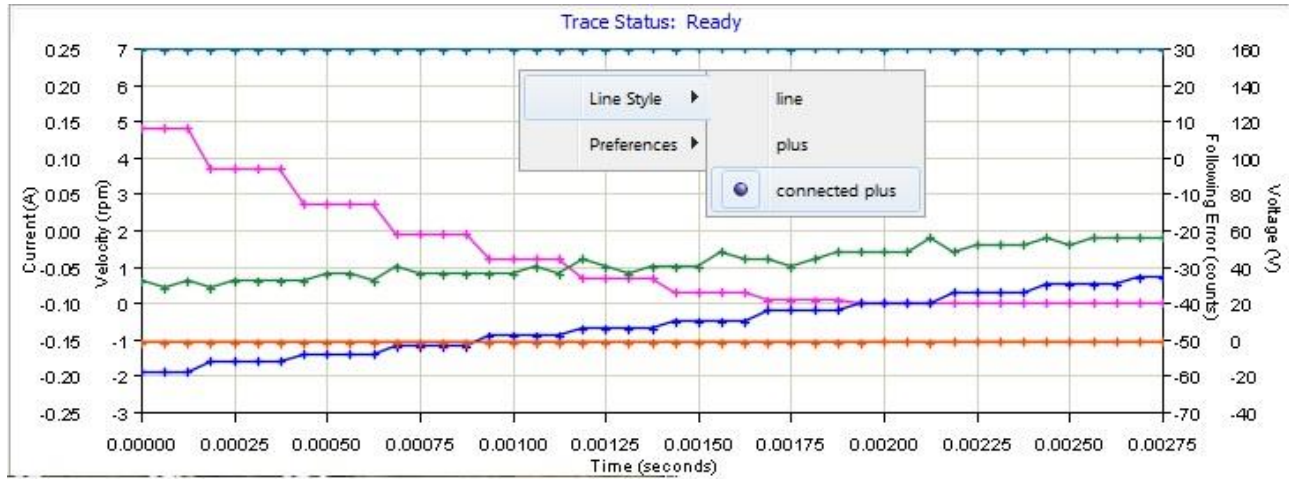

Menu	Parameter	Description
Line Style	line	A line connects the plotted data points.
	plus	The Scope plots data points as plus signs, with no connecting line.
	connected plus	Data points are plotted as plus signs and are connected with a line.
Preferences	anti-aliasing	When anti-aliasing is selected, the Scope removes screen-related jaggedness in the displayed trace. Use of this feature may slow down the refreshing of traces on slow computers.
	grid	When selected a grid is displayed on the scope screen.



Scope

**16.2.3 Trace Display Zoom**

1. Hold the left mouse button down while dragging a box around the area of interest.

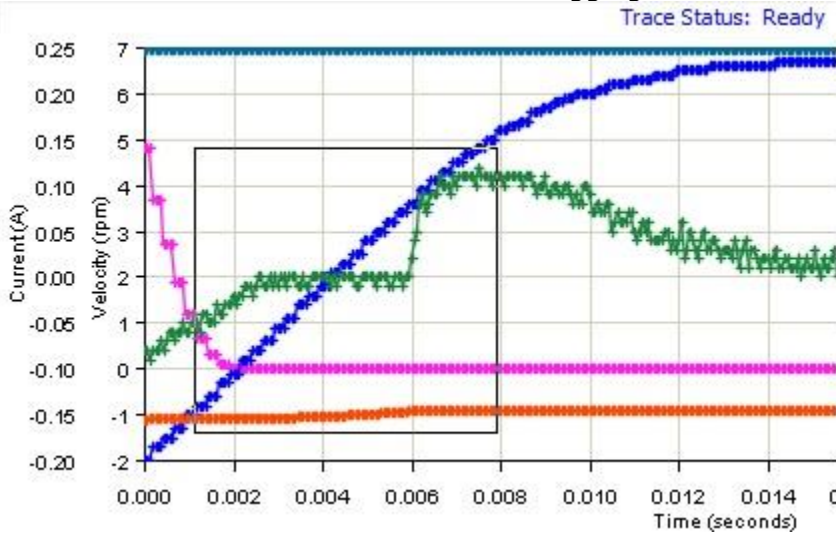

2. Release the button to let the display zoom in on the selected area.

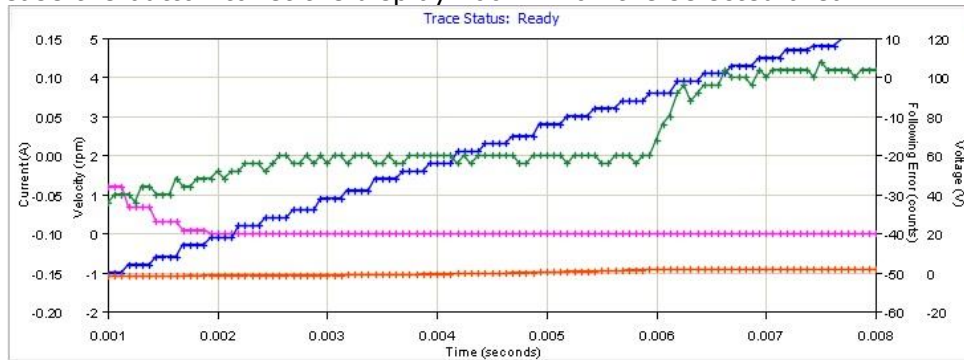

3. To restore the normal zoom level immediately, left-click anywhere on the trace. (Normal zoom level is also restored when the next trigger event occurs.)

**16.2.4 Controls**

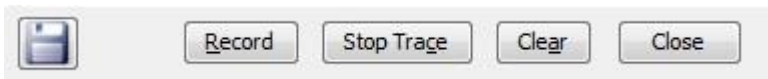

Action	Description
	Save a trace. See Scope Trace Files
	Begins recording a trace
	Stops recording a trace
	Clears the trace from the screen and trace data from buffer

## Scope

AutoSetup  
 Single Trace  
 Auto Scale Lock  
 Trace Time: 1.25 s  
 Sample Rate: 500  $\mu$ s

Function	Description
Auto Setup	When selected, the scope will be set up based on the setting for either the Function or Profile Generator (whichever is active).
Single Trace	When selected only one trace will be collected and displayed, otherwise a new trace will be started as soon as the current trace is displayed.
Auto Scale Lock	When displaying the trace data, the scope will automatically scale the vertical axis for optimal viewing. When Auto Scale Lock is selected, the y-axis scale will be locked at its current setting.
Trace Time	This is the total amount of time the trace is recorded.
Sample Rate	The rate at which each sample is collected. When tracing multiple channels, all channels are collected at approximately the same time.

## 16.3 Function Generator

The Function generators can provide inputs to the different control loops for tuning and diagnostics purposes without using an external control source.

Function Generator Profile

Apply To: Velocity

Function: Square Wave

Amplitude: 200 mm/s

Frequency: 5 Hz

Start Stop

The **Start** button starts the function or profile generator. The **Stop** button stops the generator and aborts any profiles in progress.

Parameter	Description
Apply To	Control loop to which the Excitation will be applied: Current (available in all modes), Velocity (available in velocity or position mode), or Position (available in position mode only).
Function	Function that will be applied to the control loop selected in the Apply To list box. The choices vary with the control loop selected: <b>Selected Control Functions Available Loop</b>

## Scope

	Current	Sine Wave, Square Wave, Step Forward, Step Forward and Reverse, and Impulse
	Velocity	Sine Wave, Square Wave, Step Forward, Step Forward and Reverse
	Position	Sine Wave, Square Wave
Amplitude	Amplitude of the command. Units vary depending on the value chosen in the Apply To field.	
Frequency	(Sine Wave and Square Wave only.) Frequency of input command cycle.	
Period	(Step Forward, Step Forward and Reverse, and Impulse only.) Duration of each input pulse.	

## 16.4 Profile Generator

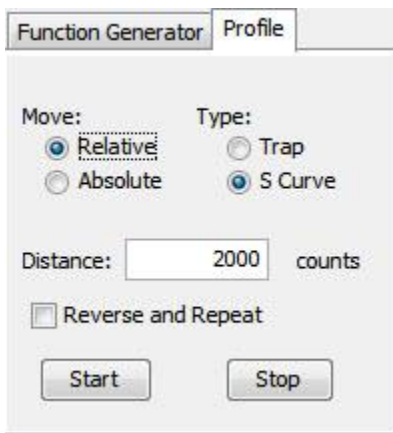

Parameter	Description
Move	Relative: Moves axis a specified distance from the starting position. Absolute: Moves axis to a specific position.
Type	Trap or S-Curve.
Distance	Distance for Relative move.
Position	Target position for Absolute move.
Reverse and Repeat	(Relative move only.) When selected, will continuously generate forward and reverse moves of the distance specified until Stop is pressed.

## 16.5 Trace Channel Variables

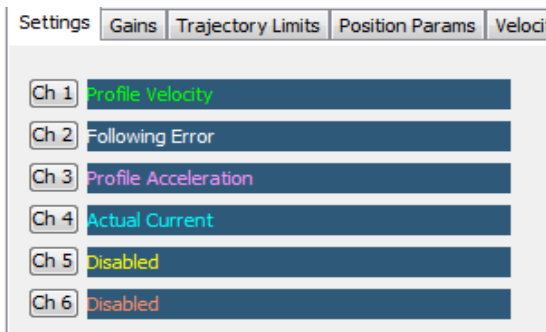

## Scope

Click the Channel button **Ch 1** to open the Trace Variable selection screen

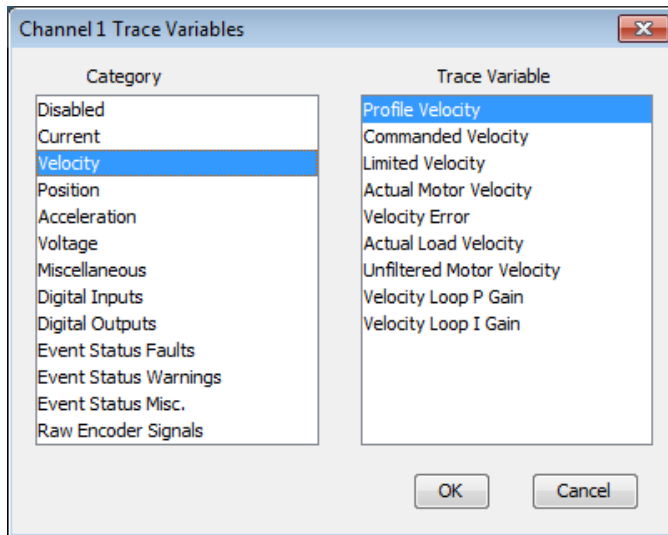

Apply To: **Axis A**

Category	Trace Variable
Disabled	<Channel disabled, no associated variable>
Current	Commanded Current, Actual Current, Limited Current, I <sup>2</sup> T Amplifier Accumulator, I <sup>2</sup> T Motor Accumulator.
Velocity	Profile Velocity, Commanded Velocity, Limited Velocity, Actual Motor Velocity, Actual Load Velocity, Unfiltered Motor Velocity, Velocity Error
Position	Commanded Position, Limited Position, Actual Load Position, Actual Motor Position, Following Error, Passive Load Position
Acceleration	Profile Acceleration
Voltage	Analog Command, Bus Voltage, Analog sin Input, Analog cos Input, Terminal Voltage Stepper, Terminal Voltage Servo
Miscellaneous	Motor Phase Angle, Amplifier Temperature, Hall States
Digital Inputs	Digital input line states
Digital Outputs	Digital output line states
Event Status Faults	Short Circuit, Amp Over Temperature, Over Voltage, Under Voltage, Motor Over Temperature, Feedback Error, Motor Phasing Error, Following Error, Command Input Fault, Amplifier Fault (a latched fault is active).
Event Status Warnings	Current Limited, Voltage Limited, Positive Limit Switch, Negative Limit Switch, Following Warning, Velocity Limited, Acceleration Limited, Positive Software Limit, Negative Software Limit, Pos Outside of Tracking Window, Vel Outside of Tracking Window.
Event Status Misc.	Amp Disabled by Hardware, Amp Disabled by Software, Attempting to Stop Motor, Motor Brake Active, PWM Outputs Disabled, Position Has Wrapped, Home Switch Active, In Motion, Phase Not Initialized.
Raw Encoder Signals	Primary Encoder A, Primary Encoder B, Primary Encoder X, Primary Encoder S, Secondary Encoder A, Secondary Encoder B, Secondary Encoder X, Secondary Encoder S

## 16.6 Trigger Setup

Click the Trigger Setup button  to open the Trigger Settings screen.

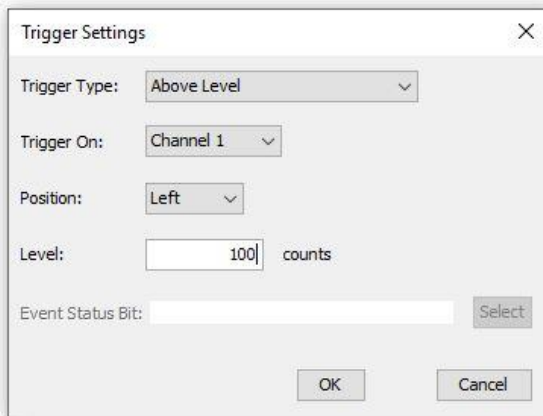

Setting	Description	
Trigger Type	<b>Type</b>	<b>Condition</b>
	Immediate Trigger	Trigger as soon as a trace is started (when the <b>Record</b> button is pressed).
	Rising Edge	Trigger when the selected channel's input changes from below to above the trigger level.
	Falling Edge	Trigger when the selected channel's input changes from above to below the trigger level
	Above Level	Trigger as soon as the selected channel's input is greater than or equal to the trigger level.
	Below Level	Trigger as soon as the selected channel's input is less than or equal to the trigger level.
	Function Generator	Trigger on the start of the next function generator cycle.
	Input Level High/Lo	Trigger when specified input is high or low
	Output Active/Inactive	Trigger when specified output is active/inactive
	Event Status Rising Edge/Falling Edge	Trigger on the rising or falling edge of an event status bit.
	Raw Encoder Signal Level H/Lo	Triggers when the raw encoder signal is Hi/Lo
Trigger On	Selects which channel will be used as the trigger source.	
Position	Selects placement of the trigger event on the screen. (Value is not configurable for Immediate or Function Generator trigger types.) <ul style="list-style-type: none"> <li>• Left for optimal viewing of events following the trigger.</li> <li>• Middle for optimal viewing of events preceding and following the trigger.</li> <li>• Right for optimal viewing of events preceding the trigger.</li> </ul>	
Level	Sets the trigger level, in units appropriate to the channel selected.	

## Scope

Event Status Bit	With an event status trigger type selected, choose the status bit that will trigger the trace. For descriptions of the event status word.
------------------	-------------------------------------------------------------------------------------------------------------------------------------------

### 16.7 Measurement Tab

The Measurement tab allows you to measure and analyze data from up to three parameters during an interval defined by adjustable cursors. The Cursor Data area displays a parameter's values at the left and right cursor locations, and the difference between the two values (Delta). The Analysis area displays the minimum, maximum, average, and root mean square of the parameters during the cursor period.

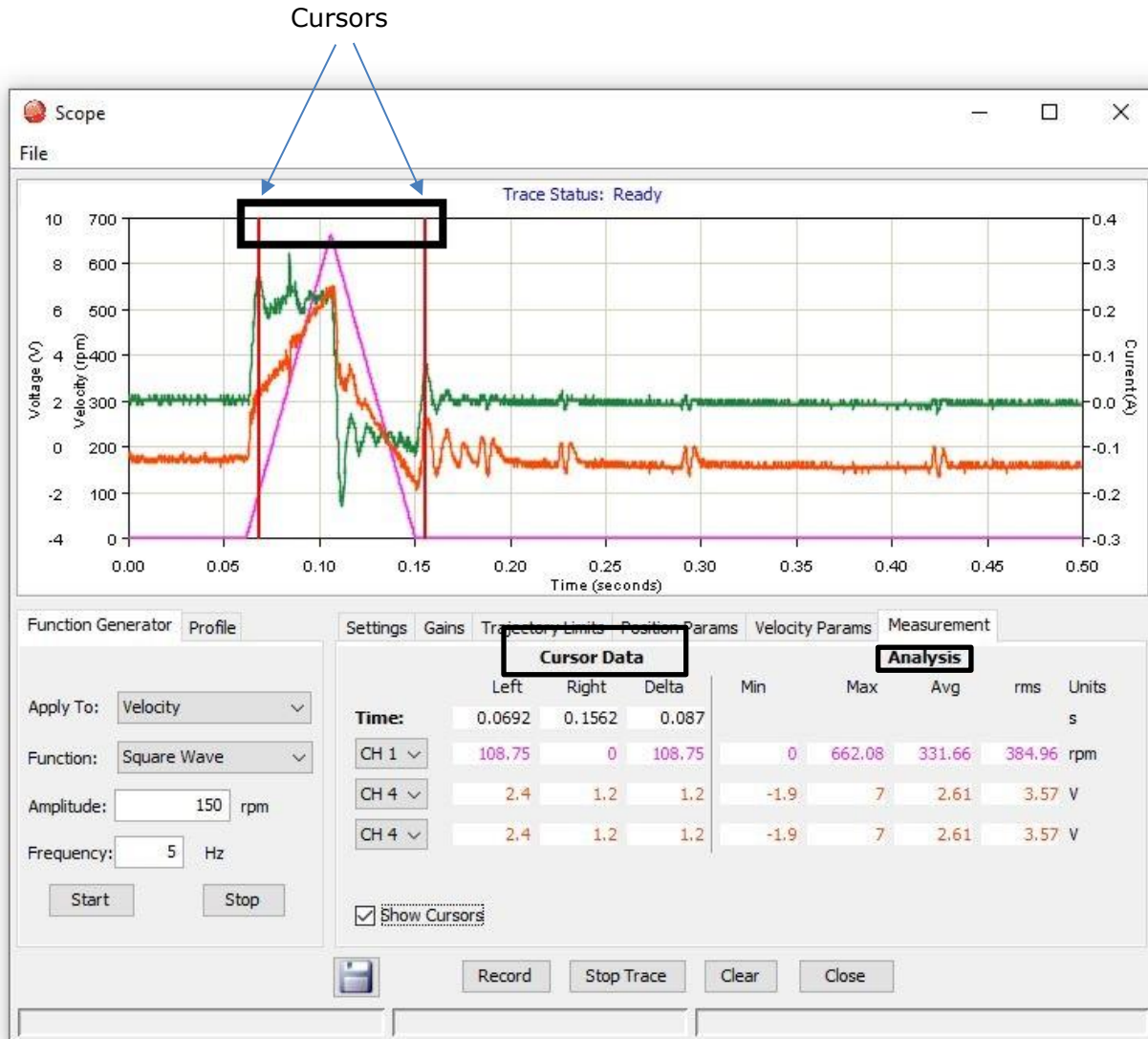

When **Show Cursors** is not set, the Cursor Data fields are inactive and the Analysis fields show calculations based on data from the entire trace cycle.

## Scope

1. To display cursors and activate the Cursor Data fields, set **Show Cursors**
2. To move a cursor, click on the cursor and hold the left button while dragging the cursor to the desired location. Release the left button to place the cursor in the new location.
3. To select a parameter to measure and analyze within the cursors, choose a channel in one of the three channel lists on the Measurement tab:

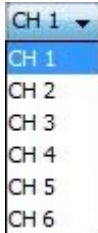

## 16.8 Control Loop Parameters

The Oscilloscope provides convenient access to all the control loop parameters that might be used in tuning and diagnosing an amplifier. The user can adjust these parameters and see the results immediately on the scope. Control loop parameters are accessed through a set of tabs, shown below.

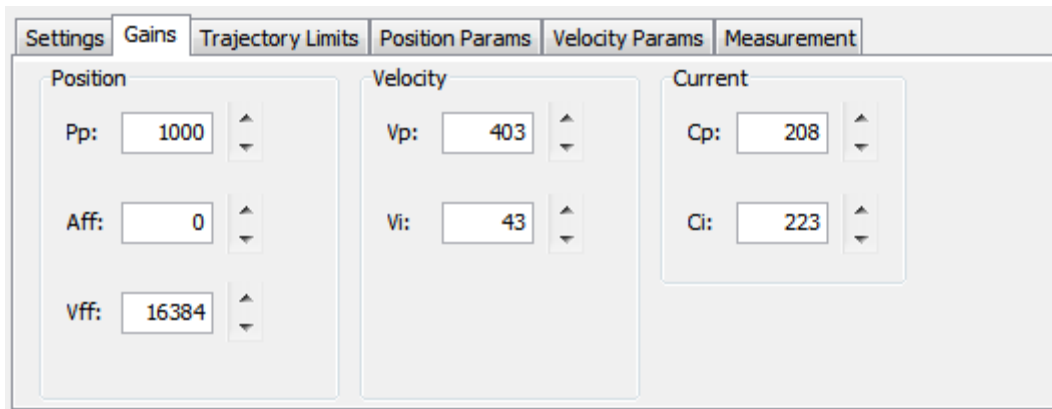

Note that the parameters represented on these tabs can also be accessed through the screens used to configure the control loops and the digital position input. Changing a value in the Scope tool automatically updates the value on the other screens where it appears, and vice versa. Control loop parameter tab descriptions follow.

### 16.8.1 Gains Tab

Modes	Gains	Description	For More Information
Position mode only	Pp	Position loop proportional gain.	<a href="#">Position Loop Gains</a>
	Aff	Acceleration feed forward.	
	Vff	Velocity feed forward.	
Position or velocity mode only	Vp	Velocity loop proportional gain.	<a href="#">Velocity Loop Gains</a>
	Vi	Velocity loop integral gain.	
All modes	Cp	Current loop proportional gain.	<a href="#">Current Loop Gains</a>
	Ci	Current loop integral gain.	
	ECp	Encoder Correction Gain (Stepper only)	<a href="#">Encoder Correction</a>

Scope

### 16.8.2 Trajectory Limits Tab

Available in position mode.

The screenshot shows the 'Trajectory Limits' tab selected in a control interface. The interface has a tabbed menu at the top with 'Settings', 'Gains', 'Trajectory Limits', 'Position Params', 'Velocity Params', and 'Measurement'. Below the tabs, there are four rows of controls:

Maximum Velocity:	<input type="text" value="750"/>	rpm
Maximum Acceleration:	<input type="text" value="250"/>	rps <sup>2</sup>
Maximum Deceleration:	<input type="text" value="250"/>	rps <sup>2</sup>
Maximum Jerk:	<input type="text" value="10000"/>	rps <sup>3</sup>

For more information see [Position Loop Setup and Tuning](#).

### 16.8.3 Position Loop Parameters

Available in position mode.

The screenshot shows the 'Position Loop Parameters' tab selected in a control interface. The interface has a tabbed menu at the top with 'Settings', 'Gains', 'Trajectory Limits', 'Position Params', 'Velocity Params', and 'Measurement'. Below the tabs, there are several controls:

- Position Tracking:** A sub-panel containing:
  - Window:  counts
  - Time:  ms
- Actual Position:  counts
- 
- Following Error:  counts
- Disable Following Error Fault

Set Zero Position sets the amplifier's actual position count to zero. For more information, see [Position Loop Setup and Tuning](#).

### 16.8.4 Velocity Loop Parameters

Available in position and velocity modes.

The screenshot shows the 'Velocity Loop Parameters' tab selected in a control interface. The interface has a tabbed menu at the top with 'Settings', 'Gains', 'Trajectory Limits', 'Position Params', 'Velocity Params', and 'Measurement'. Below the tabs, there are several controls:

- Velocity Tracking:** A sub-panel containing:
  - Window:  rpm
  - Time:  ms
- Accel Limit:  rps<sup>2</sup>
- Decel Limit:  rps<sup>2</sup>

For information see [Velocity Loop Setup and Tuning](#). Initial current loop proportional gain (**Cp**) and current loop integral gain (**Ci**) values can be calculated with [Calculate](#).



## Scope

Click [I Loop](#) to open the Current Loop screen:

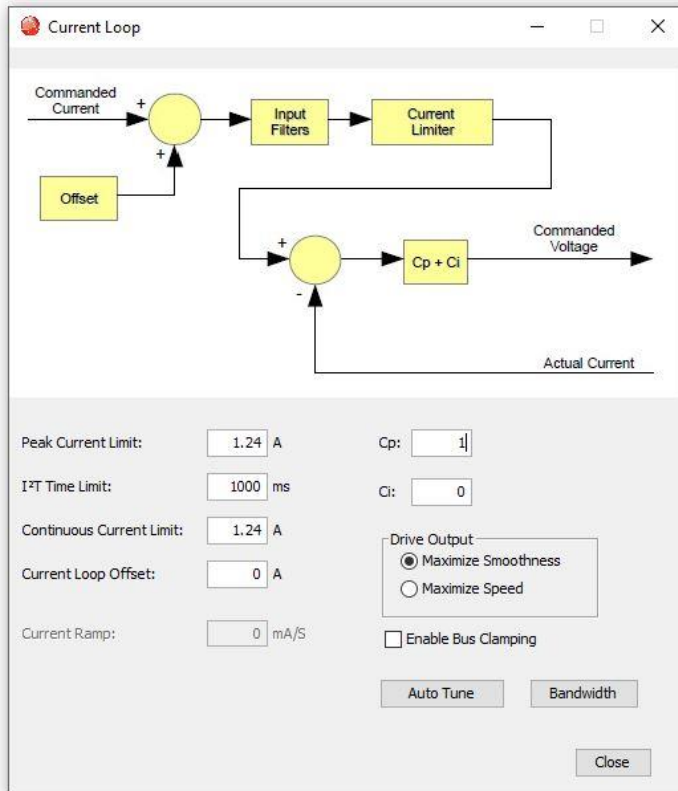

Parameter	Description
Peak Current Limit	Used to limit the peak phase current to the motor. Max value depends upon the amplifier model; Min value > continuous limit.
I <sup>2</sup> T Time Limit	Sets I <sup>2</sup> T Time Limit in ms. See I <sup>2</sup> T Limit Algorithm.
Continuous Current Limit	Used to limit the Phase Current. Max Value is < Peak Current and depends upon the amplifier model. Min value: 0
Current Loop Offset	Sets current loop offset. Leave it set to zero until after tuning. For more information, see
Cp	Current loop proportional gain. Range 0 – 32,767.
Ci	Current loop integral gain. Range 0 – 32,767.
Current Ramp (mA/s)	Used only when in current mode. Default value is 0 which disables the ramp rate limit.
Drive Output	<b>Maximize Smoothness:</b> Amplifier uses circular vector limiting to produce smooth operation even into the voltage limits. <b>Maximize Speed:</b> Allows for slightly more of the bus voltage to be used when in the voltage limit. This may produce a small disturbance at top speed.
Enable Bus Clamping	Checking the option disables space vector modulation and may reduce 120 Hz AC line ripple when holding position near zero current. If unchecked may allow for higher speeds.
Auto Tune	See Current Loop Auto Tune.

## Scope

Bandwidth	Measure bandwidth using the Cp and Ci values now in the amplifier.
-----------	--------------------------------------------------------------------

### 16.8.5 Current Loop Manual Tune

#### NOTE:

- During tuning, observe any warnings or faults that appear in the status bar of the scope.
- Some users prefer the Auto Tune feature. See Current Loop Auto Tune.

11. Click the Scope Tool .

12. Choose **Current**  from the Function Generator Apply To: drop list.

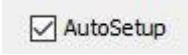
13. On the Settings tab, make sure Auto Setup  is selected. Auto Setup automatically sets the following parameters:

<b>Function Generator Tab</b>	
<b>Parameter</b>	<b>Description</b>
Function	Square Wave.
Amplitude	10% of continuous current value.
Frequency	100 Hz.
<b>Settings Tab</b>	
Channel 1	Commanded current (green).
Channel 2	Actual current (white).

14. Verify that the Amplitude value  is not excessive for the motor.

15. Click **Start** .

16. On the **Gains tab**, adjust current loop proportional gain (Cp) and the current loop integral gain (CI) to obtain a desired wave form.

- Set current loop integral gain (Ci) to zero.
- Raise or lower Cp to obtain desired step response. (Typically, little or no overshoot with a 100 Hz, low-current square wave.) If the Cp value is too large, ringing may occur. If the Cp value is too low, bandwidth decreases.

## Scope

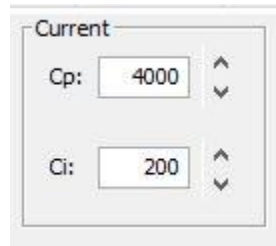

17. Adjust current loop integral gain (Ci) until desired settling time is obtained.

**Note:** The image below shows a good example of a good current loop tuning, in which the wave forms for commanded and the actual current are very similar, without any ringing or overshoot.

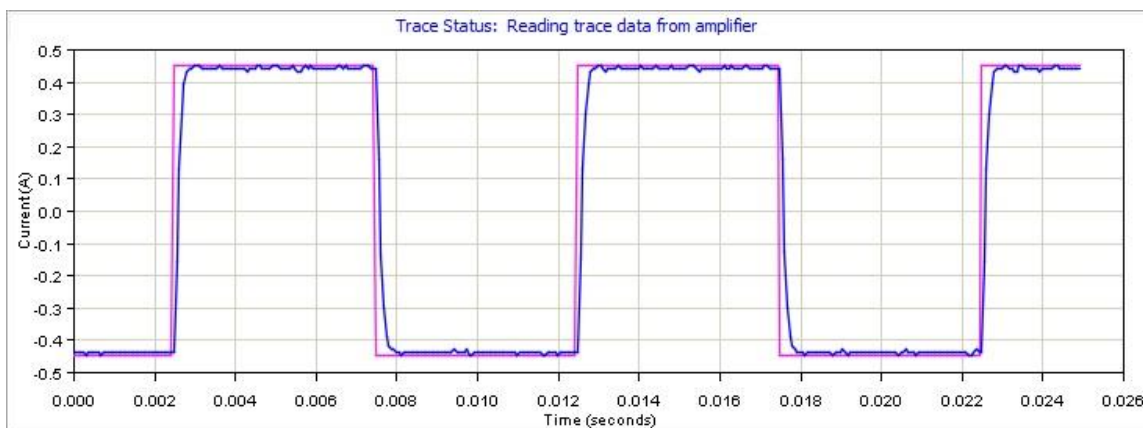

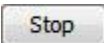
18. Press **Stop**  to stop the function generator.

19. On the Main screen, click **Save to Flash**  to avoid losing the changes.

20. On the main screen, select  and click on **Bandwidth** to measure the bandwidth. Verify that the bandwidth measured is sufficient for the application. Typical bandwidth value is 1.2kHz  $\pm$  200 Hz.

### 16.8.6 Current Loop Auto Tune

The current loop Auto Tune algorithm applies a square-wave command to the current loop and adjusts current loop proportional gain (Cp) and current loop integral gain (Ci) until a desirable waveform is obtained.

Initial current loop proportional gain (**Cp**) and current loop integral gain (**Ci**) values can be calculated with [Calculate](#).

7. Click I Loop  to open the Current Loop screen:

## Scope

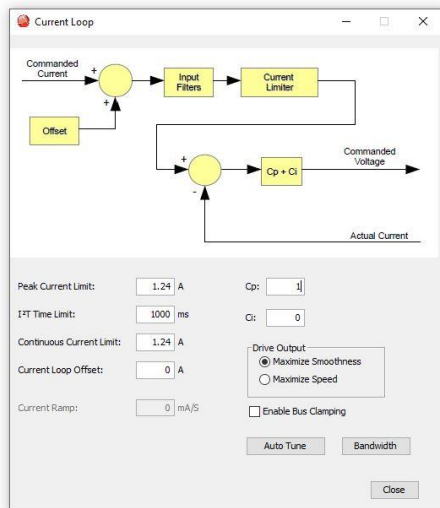

8. Verify that the amplifier is hardware enabled.

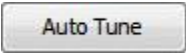
9. Click Auto Tune  to open the screen and start the Current Loop Auto Tune.

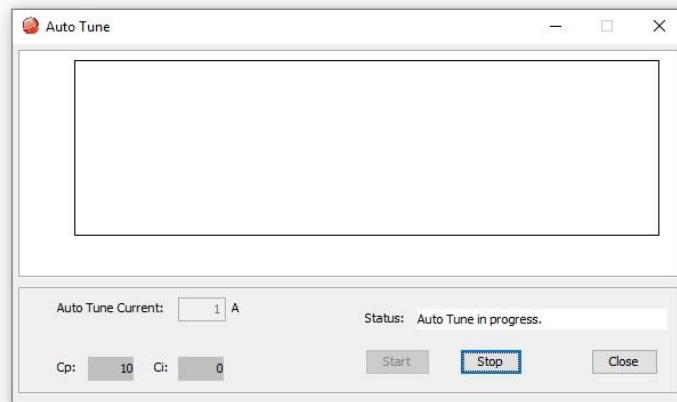

10. To Change the Auto Tune Current, click **Stop**. Enter the new current in the Auto Tune Current field, and then click **Start**.

11. Observe the Auto Tune process and results.

A typical example is given below:

## Scope

- Set  $C_p$  and  $C_i$  to zero and adjust  $C_p$  and  $C_i$  for optimal values.

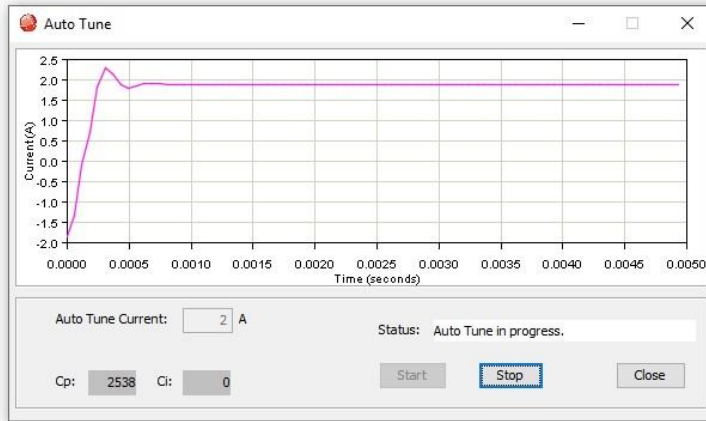

- Use a frequency sweep to determine the small signal, current loop bandwidth.

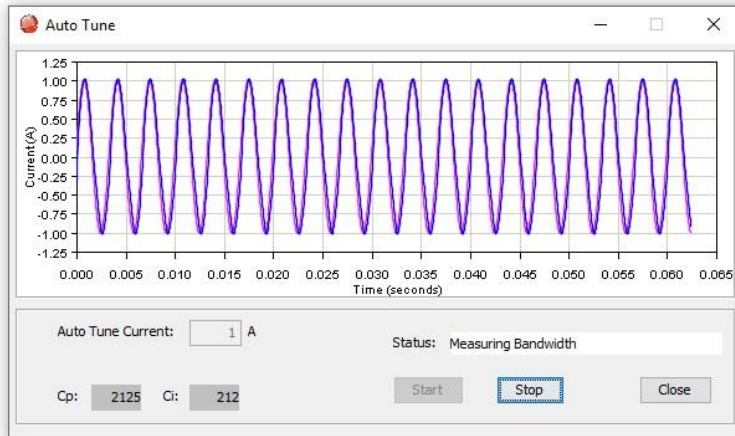

- A set of  $C_p$  and  $C_i$  alternatives, and the bandwidth measured using the high  $C_p$  and  $C_i$  values are displayed.

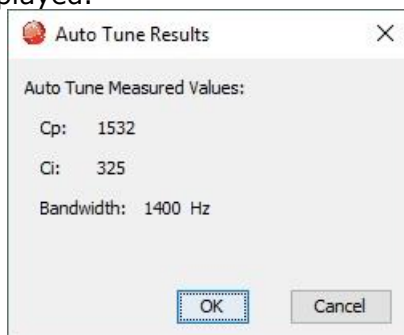

- Click **OK** to keep the new  $C_p$  and  $C_i$  values in RAM that auto tune measured. Click **Cancel** to restore the original  $C_p$  and  $C_i$  values.

### 16.8.7 Notes on the Current Mode and Current Loop

#### Current Loop Diagram

As shown below, the “front end” of the current loop is a limiting stage. The limiting stage accepts a current command, applies limits, and passes a limited current command to the summing junction. The summing junction takes the commanded current, subtracts the actual current (represented by the feedback signal), and produces an error signal. This error signal is then processed using the integral and proportional gains to produce a command. This command is then applied to the amplifier’s power stage.

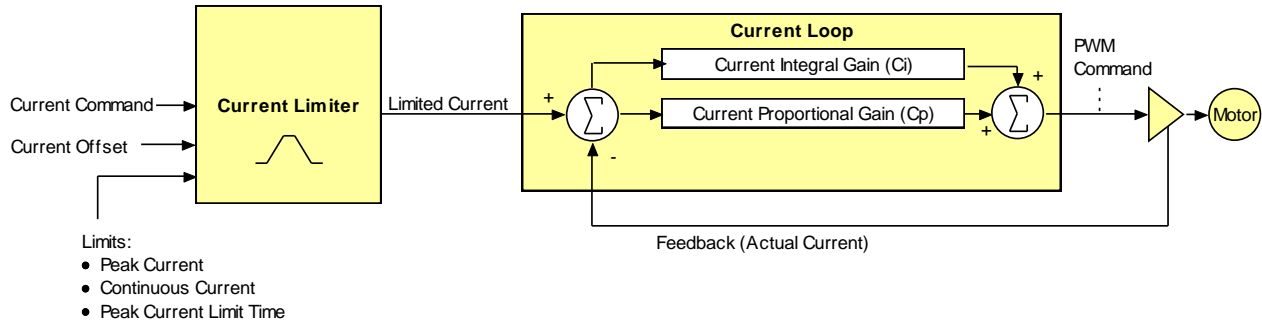

#### Current Loop Inputs

- The amplifier’s analog or PWM inputs.
- A CANopen network via the amplifier’s CAN interface.
- A Copley Virtual Motion (CVM) control program.
- The amplifier’s internal function generator.

In velocity or position modes, the current command is generated by the velocity loop.

#### 16.8.8 Offset

The current loop offset is intended for use in applications where there is a constant force applied to, or required of, the servomotor and the system must control this force. Typical applications would be a vertical axis holding against gravity, or web tensioning. This offset value is summed with the current command before the limiting stage.

#### 16.8.9 Limits

The current command is limited based on the following parameters:

Limit	Description
Peak Current Limit	Maximum current that can be generated by the amplifier for a short duration of time. This value cannot exceed the peak current rating of the amplifier.
Continuous Current Limit	Maximum current that can be constantly generated by the amplifier.
I2T Time Limit	Maximum amount of time that the peak current can be applied to the motor before it must be reduced to the continuous limit or generate a fault. For more details, see I2T Time Limit Algorithm. Note: Although the current limits set by the user may exceed the amplifier's internal limits, the amplifier operates using both sets of limits in parallel, and therefore will not exceed its own internal limits regardless of the values programmed.
Ramp	Rate of change in current command. Used to limit jog moves initiated from the Control Panel Jog function in current mode, and in advanced Indexer Program functions.

Scope

**16.8.10 Current Loop Gains**

Gain	Description
Cp - Current loop proportional	The current error (the difference between the actual and the limited commanded current) is multiplied by this value. The primary effect of this gain is to increase bandwidth (or decrease the step-response time) as the gain is increased.
Ci - Current loop integral	The integral of the current error is multiplied by this value. Integral gain reduces the current error to zero over time. It controls the DC accuracy of the loop, or the flatness of the top of a square wave signal. The error integral is the accumulated sum of the current error value over time.

**16.8.11 Current Loop Output**

The output of the current loop is a command that sets the duty cycle of the PWM output stage of the amplifier.

**16.9 Velocity Loop Setup and Tuning**

Initial velocity loop proportional gain (**Vp**) and velocity loop integral gain (**Vi**) values can be calculated with [Calculate](#).

Click the V Loop button  on the Main screen (contents vary with model and configuration):

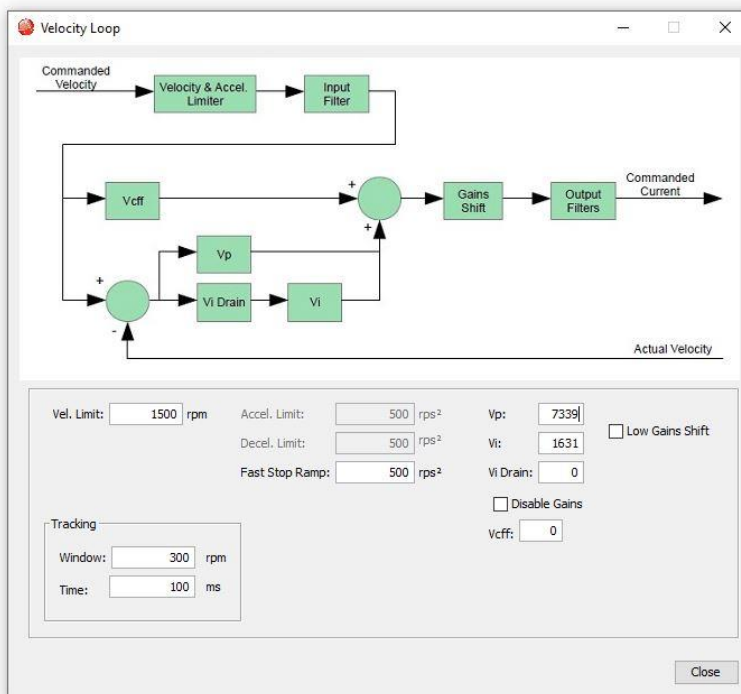

Parameter	Description
Velocity Limit	Top speed limit. Max value may depend upon the back EMF & the Encoder value. Min value: 0.

## Scope

Acceleration Limit	Maximum acceleration rate. Max value may depend upon load, inertia, & peak current. Min value: 1. (Does not apply in position mode.)
Deceleration Limit	Maximum deceleration rate. Max value may depend upon load, inertia, & peak current. Min value: 1. (Does not apply in position mode.)
Tracking Window	See <a href="#">Position and Velocity Tracking Windows</a>
Tracking Time	
Vp	Velocity loop proportional gain. Range: 0 to 32,767.
Vi	Velocity loop integral gain. Range: 0 to 32,767.
Fast Stop Ramp	Deceleration rate used by the velocity loop when the amplifier is hardware disabled. Range: 0 to 100,000,000. Default: velocity loop Decel. Limit value.
Low Gains Shift	Increases the resolution of the units used to express Vp and Vi, providing more precise tuning. For more information, see Velocity Gains Shift.
Hi Gains Shift	Decreases the resolution of the units used to express Vp and Vi, providing more precise tuning. For more information, see Velocity Gains Shift.
Vi Drain (integral bleed)	Vi drain modifies the effect of velocity loop integral gain. The higher the Vi Drain value, the faster the integral sum is lowered. Range: 0 to 32,000. Default: 0.
Vcff	Velocity loop command feed forward. The input command to the velocity loop (after limiting) is scaled by this value and added to the output of the velocity loop.



## Manually Tune the Velocity Loop

**NOTE:** During tuning, observe any warnings that appear to the left of the trace.

10. Click the Scope Tool .

11. Choose **Velocity**  from the Function Generator Apply To: drop list.

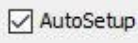
12. On the Settings tab, make sure **Auto Setup**  is selected. Auto Setup automatically sets the following parameters:

<b>Function Generator Tab</b>	
Function	Square Wave
Amplitude	10% of maximum velocity value
Frequency	5 Hz
<b>Settings Tab</b>	
Channel 1	Limited velocity (green)
Channel 2	Actual Motor Velocity (white)

13. Verify that the amplitude value  is not excessive for the motor.

14. Click Start .

15. On the Gains tab, adjust velocity loop proportional gain ( $V_p$ ):

- Set velocity loop integral gain ( $V_i$ ) to zero.
- Raise or lower proportional gain ( $V_p$ ) to obtain desired step response. (Typically, little or no overshoot on a 5 Hz small, slow-speed square wave.)

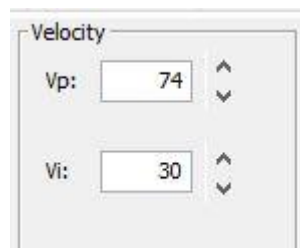

16. Adjust velocity loop integral gain ( $V_i$ ) until desired settling time is obtained.

**Note:** The image below shows a good example of a good velocity loop tuning, in which the wave forms for commanded and the actual velocity are very similar.

## Scope

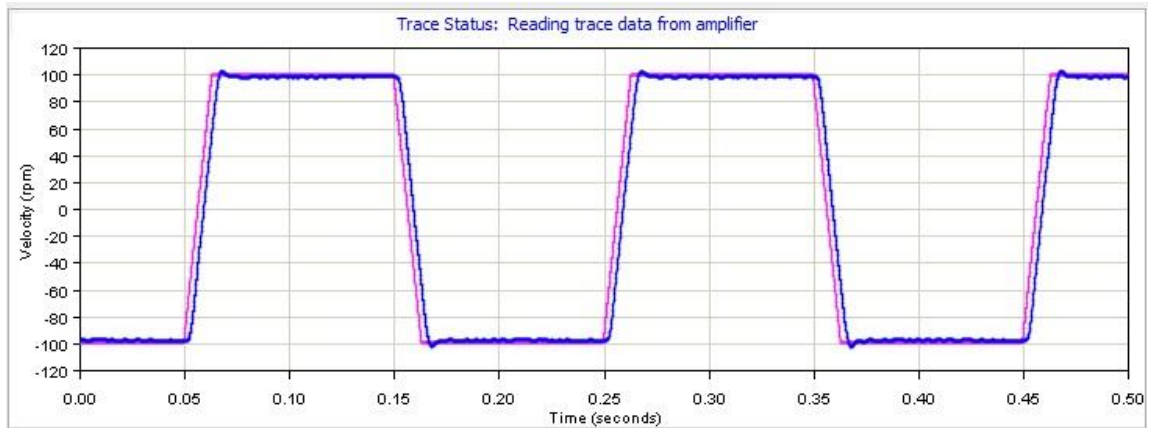

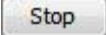
17. Click Stop  to stop the function generator.

18. On the Main screen, click **Save to Flash**  to avoid losing the changes.

## 16.10 Notes on the Velocity Mode and Velocity Loop

### 16.10.1 Velocity Loop Diagram

As shown below, the velocity loop limiting stage accepts a velocity command, applies limits, and passes a limited velocity command to the input filter. The filter then passes a velocity command to the summing junction. The summing junction subtracts the actual velocity, represented by the feedback signal, and produces an error signal. (The velocity loop feedback signal is always from the motor feedback device even when an additional encoder is attached to the load.) The error signal is then processed using the integral and proportional gains to produce a current command. Programmable digital filters are provided on both the input and output command signals.

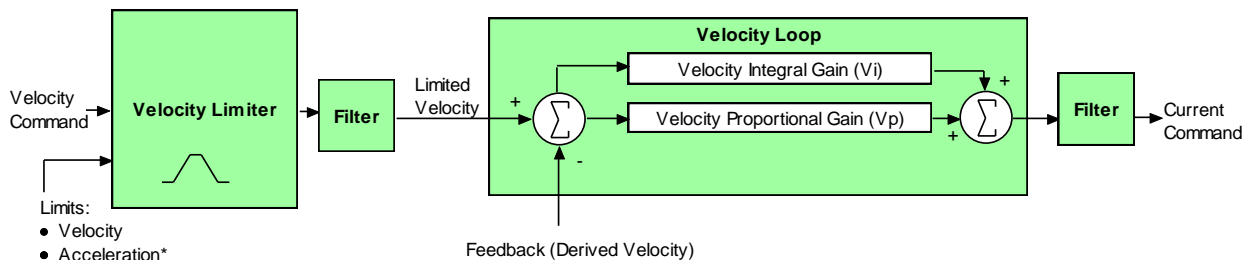

Limits:

- Velocity
- Acceleration\*
- Deceleration\*
- Emergency Stop Deceleration\*

\*Not used when velocity loop is controlled by position loop. See "Velocity Loop Limits" for details.

### 16.10.2 Inputs

In velocity mode, the velocity command comes from one of the following:

- The amplifier's analog or PWM inputs.
- A CANopen network via the amplifier's CAN interface.
- A Copley Virtual Motion (CVM) control program.
- The amplifier's internal function generator.

In position mode, the velocity command is generated by the position loop.

### 16.10.3 Velocity Loop Limits

The velocity command is limited based on the following set of parameters designed to protect the motor and/or the mechanical system.

<b>Limiter</b>	<b>Description</b>
Velocity Limit	Sets the maximum velocity command input to the velocity loop.
Acceleration Limit	Limits the maximum acceleration rate of the commanded velocity input to the velocity loop. This limit is used in velocity mode only. In position mode, the trajectory generator handles acceleration limiting.
Deceleration Limit	Limits the maximum deceleration rate of the commanded velocity input to the velocity loop. This limit is used in velocity mode only. In position mode, the trajectory generator handles deceleration limiting.
Fast Stop Ramp	Specifies the deceleration rate used by the velocity loop when the amplifier is hardware disabled. (Fast stop ramp is not used when amplifier is software disabled.) If the brake output is active, the fast stop ramp is used to decelerate the motor before applying the brake.  Note that Fast Stop Ramp is used only in velocity mode. In position mode, the trajectory generator handles controlled stopping of the motor. There is one exception: if a non-latched following error occurs in position mode, then the amplifier drops into velocity mode and the Fast Stop Ramp is used.

**16.10.4 Diagram: Effects of Limits on Velocity Command**

The following diagram illustrates the effects of the velocity loop limits.

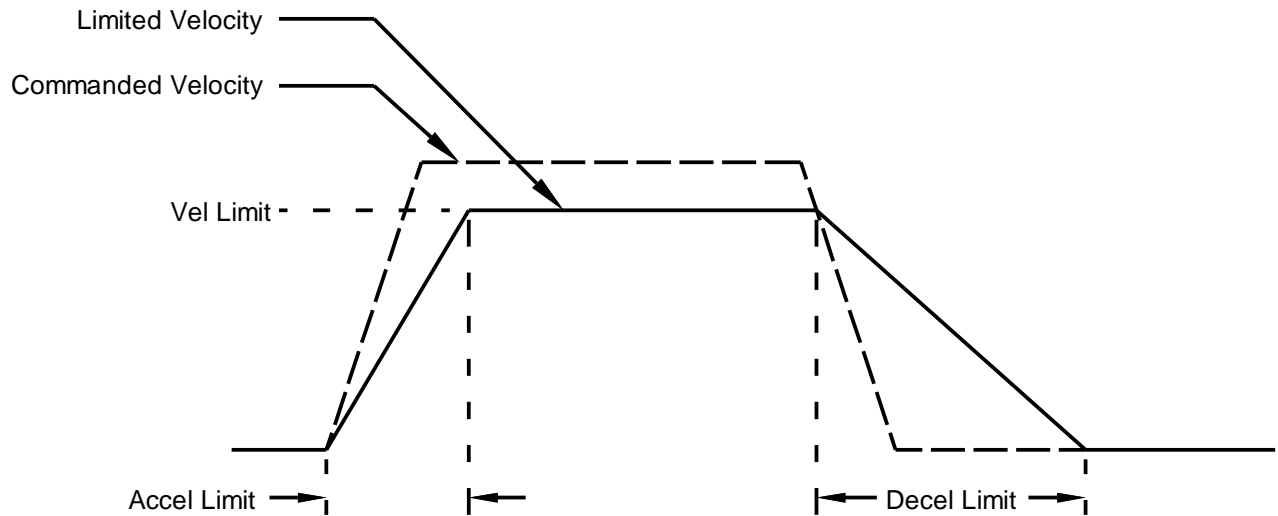

**16.10.5 Velocity Loop Gains**

The velocity loop uses these gains:

<b>Gain</b>	<b>Description</b>
Vp - Velocity loop proportional	The velocity error (the difference between the actual and the limited commanded velocity) is multiplied by this gain. The primary effect of this gain is to increase bandwidth (or decrease the step-response time) as the gain is increased.
Vi - Velocity loop integral	The integral of the velocity error is multiplied by this value. Integral gain reduces the velocity error to zero over time. It controls the DC accuracy of the loop, or the flatness of the top of a square wave signal. The error integral is the accumulated sum of the velocity error value over time.

**16.10.6 Velocity Gains Shift**

The Velocity Gains Shift feature adjusts the resolution of the units used to express  $V_p$  and  $V_i$ , providing more precise tuning. If the non-scaled value of  $V_p$  or  $V_i$  is 64 or less, the Low Gains Shift option is available to increase the gains adjustment resolution. (Such low values are likely to be called for when tuning a linear motor with an encoder resolution finer than a micrometer.) If the non-scaled value of  $V_p$  or  $V_i$  is 24001 or higher, the High Gains Shift option is available to decrease the gains adjustment resolution.

**16.10.7 Velocity Loop Filters**

See [Standard Filter Types](#).

**16.10.8 Velocity Loop Outputs**

The output of the velocity loop is a current command used as the input to the current loop.

**16.10.9 Proper Tracking Over Time**

As described earlier, position error is the difference between the limited position output of the trajectory generator and the actual position. Velocity error is the difference between commanded and actual velocity.

When the position or velocity error exceeds the programmed tracking window value, a status word bit is set. The bit is not reset until the error remains within the tracking window for the programmed tracking time.

**16.10.10 Velocity Tracking Illustration**

The following diagram illustrates the use of tracking window and time settings in velocity mode.

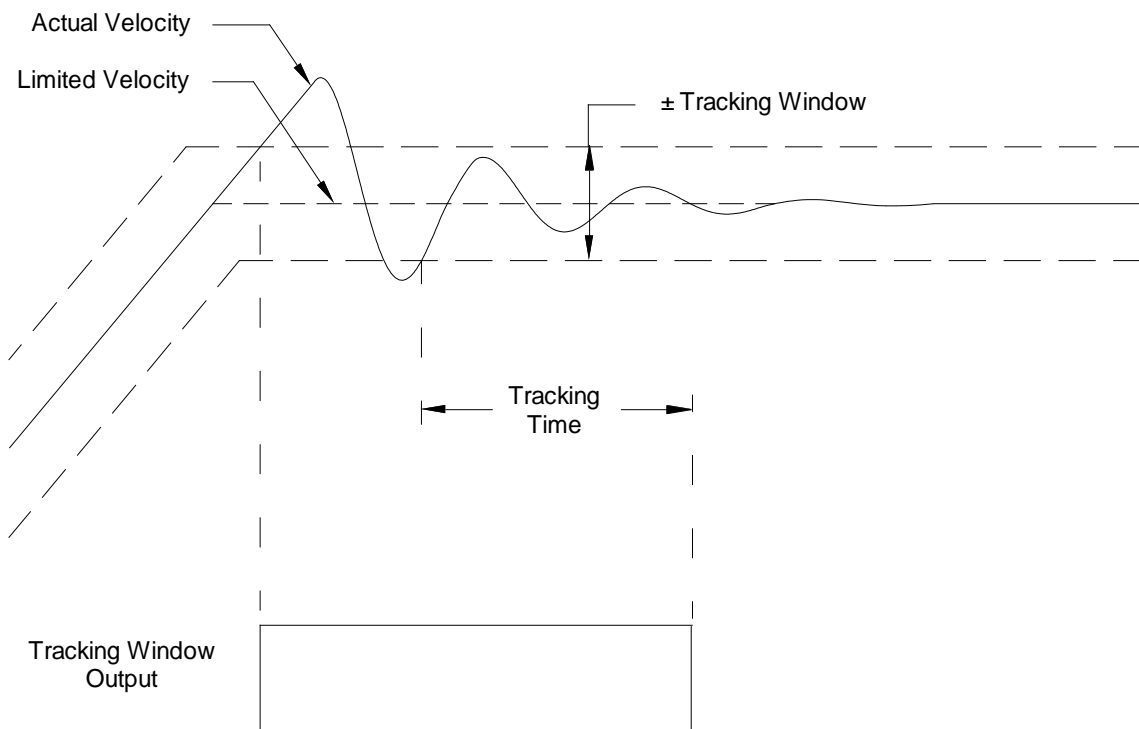

## 16.11 Position Loop Setup and Tuning

Initial position loop proportional gain (Pp), velocity feed forward (Vff), and acceleration feed forward (Aff) values can be calculated with [Calculate](#).

Click the P Loop button  on the Main screen.

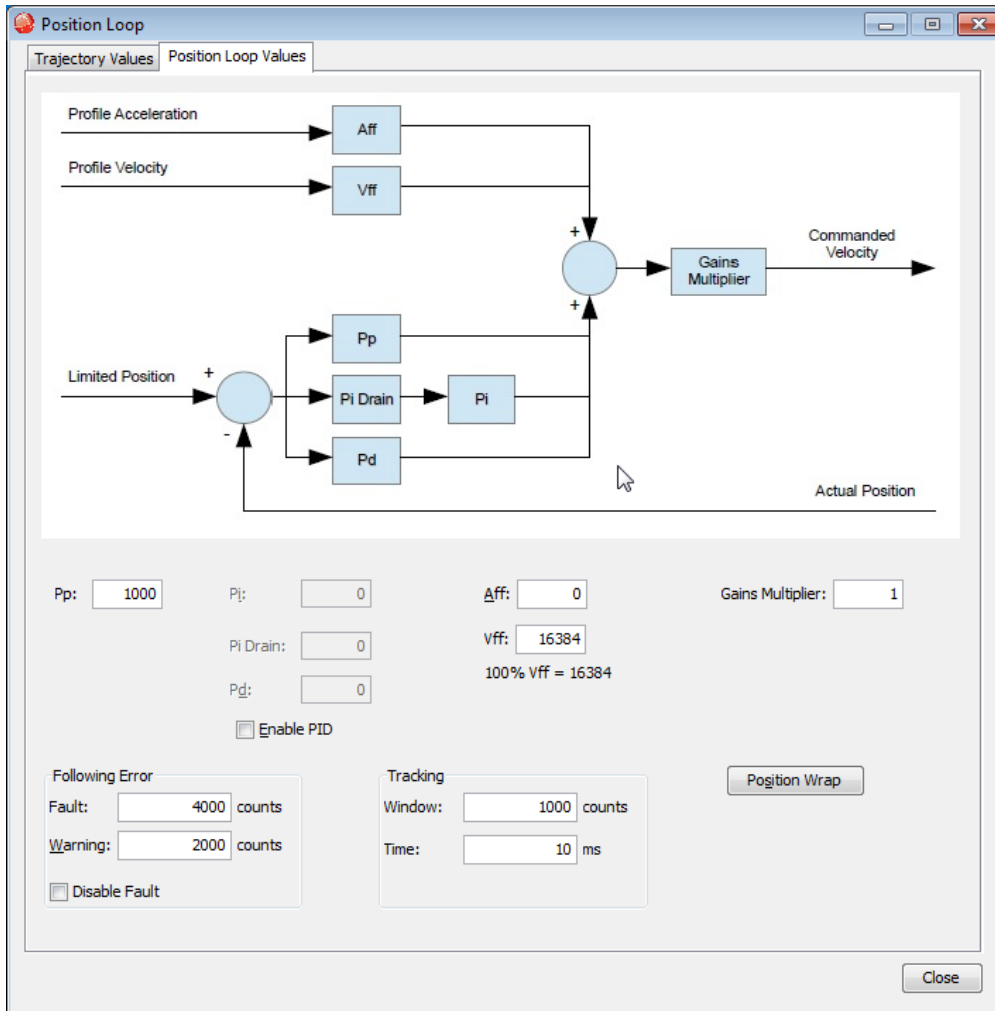

Parameter	Description
Aff	Acceleration feed forward. Range: 0 to 32,767. See <a href="#">Trajectory Limits</a>
Vff	Velocity feed forward. Range: 0 to 32,767. 100% Vff: 16,384. <a href="#">Trajectory Limits</a>
Pp	Position loop proportional gain. Range: 0 to 32,767. See <a href="#">Trajectory Limits</a>
Gains Multiplier	Position loop output is multiplied by this value before going to the velocity loop. In dual encoder systems, the multiplier's initial value is calculated based on the ratio of motor encoder turns to position encoder turns.
Following Error Fault	The level (in encoder counts) at which the following error produces a fault, which stops the servo loop. We recommend raising the fault level before tuning the loop. See <a href="#">Following Error Faults</a>

## Scope

Following Error Warning	The level (in counts) at which the following error produces a warning (without stopping the loop). See <a href="#">Following Error Warnings</a>
Disable Fault	Stops following error from faulting. See <a href="#">Following Error Faults</a>
Tracking Window	Width of tracking window in counts. See <a href="#">Position and Velocity Tracking Windows</a>
Tracking Time	Position must remain in the tracking window for this amount of time to be considered tracking. See <a href="#">Position and Velocity Tracking Windows</a>
Pi	Position loop integral gain
Pd	Position loop derivative gain
Pi Drain	Position loop integral drain
Enable PID	Enables the PID parameters

Click the Position Wrap button

Position Wrap

Change/verify the position wrap parameters as needed. Set both values to zero to disable position wrapping. Note that the changes do not take effect until **OK** is pressed. For more information about this feature, see [Position Wrap](#).

Parameter	Description
Motor Position Wrap	Position at which the actual motor position count returns to zero. In a single feedback system, it also applies to the actual load position.
Load Position Wrap	Position at which the actual load position count returns to zero in dual feedback systems. If the position encoder is set to passive mode, this value applies to the passive encoder position.

## Scope

Click on the **Trajectory Values** tab.

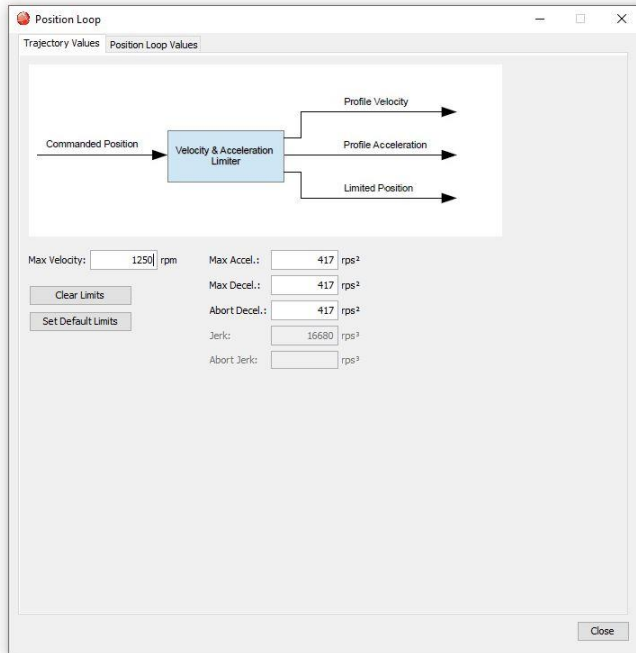

16.11.1 Parameter	16.11.2 Description
Max Velocity	Maximum trajectory velocity. Max value may depend upon the back EMF and the Max feedback count. Min:0. Default: 0.25 x motor velocity limit.
Max Accel	Maximum trajectory acceleration. Max value may depend upon the load inertia and peak current. Min:0. Default: 0.5 x velocity loop Accel. Limit value.
Max Decel	Maximum trajectory deceleration. Max value may depend upon the load inertia and peak current. Min:0 (disables limit). Default: 0.5 x velocity loop Accel. Limit value.
Abort Decel	Deceleration rate used by the trajectory generator when motion is aborted. Min:0. Default: 0.5 x velocity loop Accel. Limit value.
Jerk	Rate of change of acceleration. The value of jerk set during the calculate procedure produces an S-Curve whose maximum slope is equal to the trajectory profile slope. This value will produce a maximum acceleration that is not more than the initial default value of acceleration. Small values will produce less jerking but will take longer to complete move. Large values will produce more jerking and a more trapezoidal profile but will complete the move faster.
Note that setting limits to zero disables the trajectory generator so that the command input is not limited by the generator. Velocity is only limited by the Velocity Limit set in the Velocity Loop.	

## Manually Tune the Position Loop

**NOTE:** During tuning, observe warnings that appear to the left of the trace.

11. Click the **Scope** Tool .

12. Select the **Profile** tab .

13. On the Settings tab, make sure **Auto Setup**  **Auto Setup** is selected. Auto Setup automatically sets the following parameters:

<b>Profile Tab</b>	
Move	Relative
Type	Trap
Distance	2000 counts
Reverse and repeat	Not selected
<b>Settings Tab</b>	
Channel 1	Profile velocity (green)
Channel 2	Following error (white)

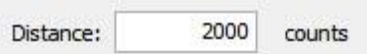
14. If the Auto Setup default profile distance is not appropriate, enter an appropriate short distance .

15. Click **Start** . The Profile Generator executes a short move.  
NOTES:

- The profile may not reach constant velocity during a short move.
- If a following error occurs, open the Control Panel and click Clear Faults.

16. Set up a trapezoidal profile by setting the trajectory limits and distance.  
See table

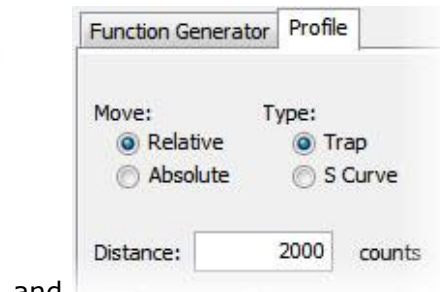

and



## Scope

<b>Trajectory Limits Tab</b>	
Maximum Velocity	Set values typical of those expected to be used in the application.
Maximum Acceleration	
Maximum Deceleration	
<b>Profile Tab</b>	
Distance	Set the move distance to produce a complete trajectory profile. Be sure that this distance does not exceed mechanical limits of the system.
Move	Relative
Type	Trap

17. Adjust position proportional gain (Pp) to minimize following error:

- On the Gains tab, set velocity feed forward (Vff) and acceleration feed forward (Aff) to zero.
- On the Profile tab, click **Start**. On the Gains tab, adjust position loop proportional gain (Pp) until best result is obtained.
- Click **Start** after each adjustment to test on a new profile move.

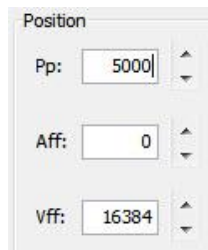

### **NOTE:**

3. Too much position loop proportional gain (Pp) might cause oscillation.
4. If a following error occurs, open the Control Panel and click **Clear Faults**.

18. Adjust velocity feed forward (Vff):

- Velocity feed forward (Vff) reduces following error in the constant velocity portion of the profile. Often, a velocity feed forward (Vff) value of 16384 (100%) provides best results.
- Click in the Vff field and adjust the value.
- Click **Start** after each adjustment to test on a new profile move.

19. Adjust acceleration feed forward (Aff):

- Acceleration feed forward (Aff) reduces following error during profile acceleration and deceleration.
- Click in the Aff field and adjust the value.
- Click **Start** after each adjustment to test on a new profile move.

## Scope

### NOTE:

1) If, after tuning the position loop, the motor makes a low frequency audible noise while enabled but not moving, the velocity loop gains ( $V_p$  and  $V_i$ ) may be lowered to reduce the noise. If the gain values are set too low, the response to instantaneous rates of change might be reduced (i.e., slow correction to disturbances or transients).

2) If the amplifier is set up to run in position mode under analog input command, and the analog command signal produces too much noise at the motor after tuning, the Analog Command Filter or the Velocity Loop Command Filter may be used to reduce the noise further.

20. Tune to multiple sets of profiles representing typical moves that might be executed in the application. Starting with Step 6, repeat the process as needed.

**Note:** The image below shows a good example of a good position loop tuning.

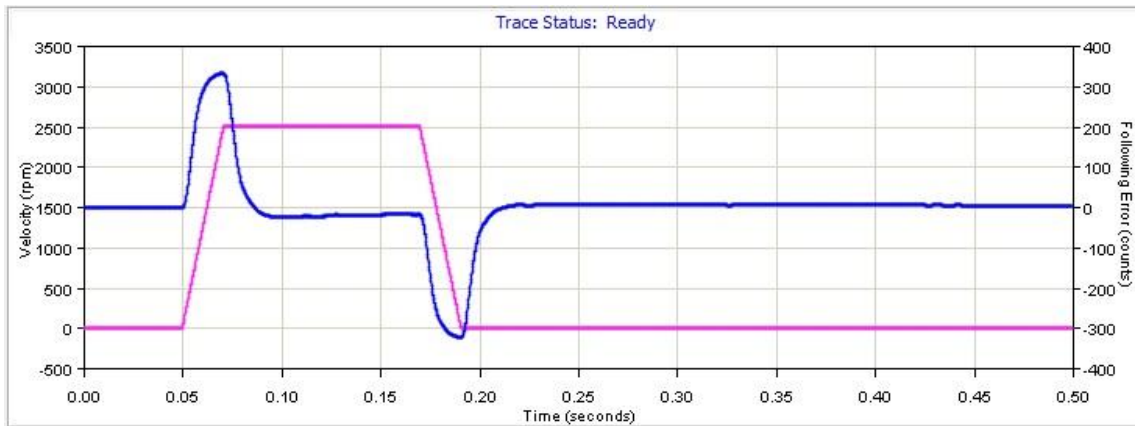

## 16.12 Scope Trace Files

The Oscilloscope can save trace data to disk that can be opened later with the Trace Viewer. When the save trace data to disk operation is performed, CME 2 saves the data in three different files:

- .sco: This is a CME 2 format which contains scope settings and trace data
- .csv: This is a standard comma-separated value file format that can be imported into spreadsheet software like Microsoft Excel.
- .txt: This is a tab-separated value file similar to the .csv file. This is intended to be imported by software that can only read tab-separated values.

The format of the .csv and the .txt files are identical except for the separator:

- Column 1: time
- Column 2: Trace Channel 1 data
- Column 3: Trace Channel 2 data (if used)
- Column n: Trace Channel n data (if used)

The trace data is in amplifier units, not user units (see Parameter Dictionary for units).

## 16.13 Trace Viewer

## Scope

The Trace Viewer screen displays the contents of .sco files. All of the trace display features (zooming, line style, etc.) as well as the measurement functions are available in this screen.

1. On the Main screen, choose **Tools**→**View Scope Files** to open the window.
2. Click **Open File**. When prompted, select the name of the file you wish to open. Then, click **Open** to display the file in the Trace Viewer window.

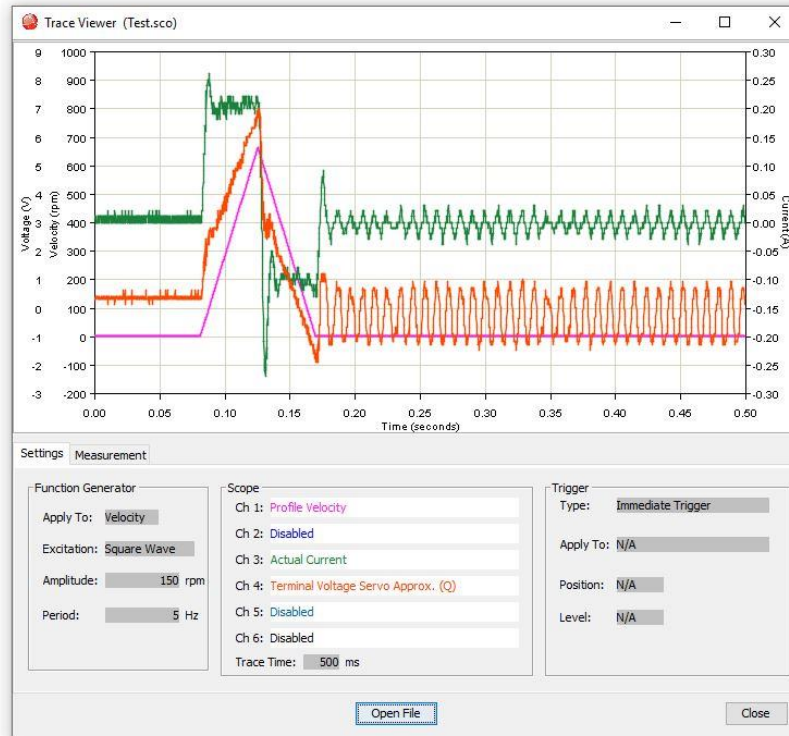

## 17 FILTERS

### 17.1 Filter Settings

The Filter Settings tab opens a window that shows what filters have been selected.

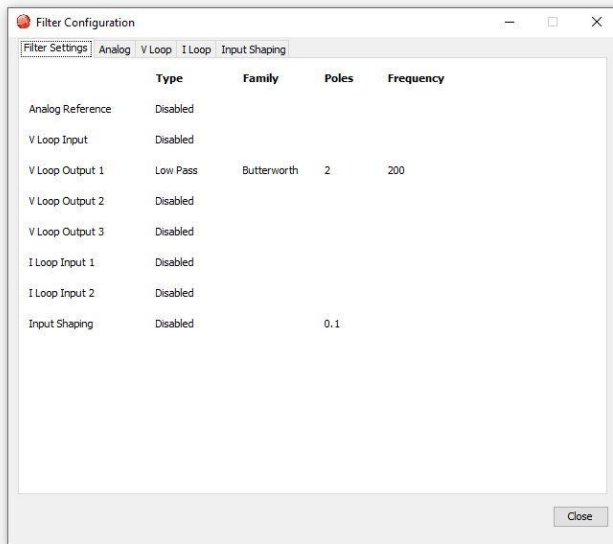

### 17.2 Filter Configuration Windows

Along with the location of a cut-off frequency on the filter curve, there are several filter configuration parameters available depending on the initial choice of: Standard Filter Types and Standard Filter Families.

Filter configuration choices may include:

- Number of Poles (the location of a cut-off frequency on the filter curve)
- Cut Off Frequency
- Frequency 2 (If two poles are chosen)
- Pass Band Ripple
- Stop Band Ripple

### 17.3 Setting Parameters

To change or view filter configurations follow these steps:

1. Choose the Configure Filters button  from the main screen to open the Filter Configuration screen.
2. To view present filter settings, choose the Filter Settings tab. Choose other tabs to configure Analog, V Loop, I Loop or Input Shaping settings.



## 17.4 Input Shaping

Input shaping is a method by which unwanted command induced vibrations are kept to a minimum by damping them with superimposed impulses. This produces a command that will drive the system with limited residual vibration.

To set the input shaping parameters, first measure the mechanical frequency; see [Measuring Mechanical Vibration](#).

Below is a diagram of the input shaping process.

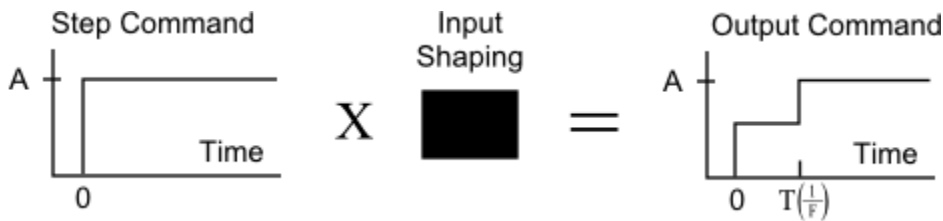

Below is a sensitivity curve. When  $F = F_m$ , there is zero vibration.

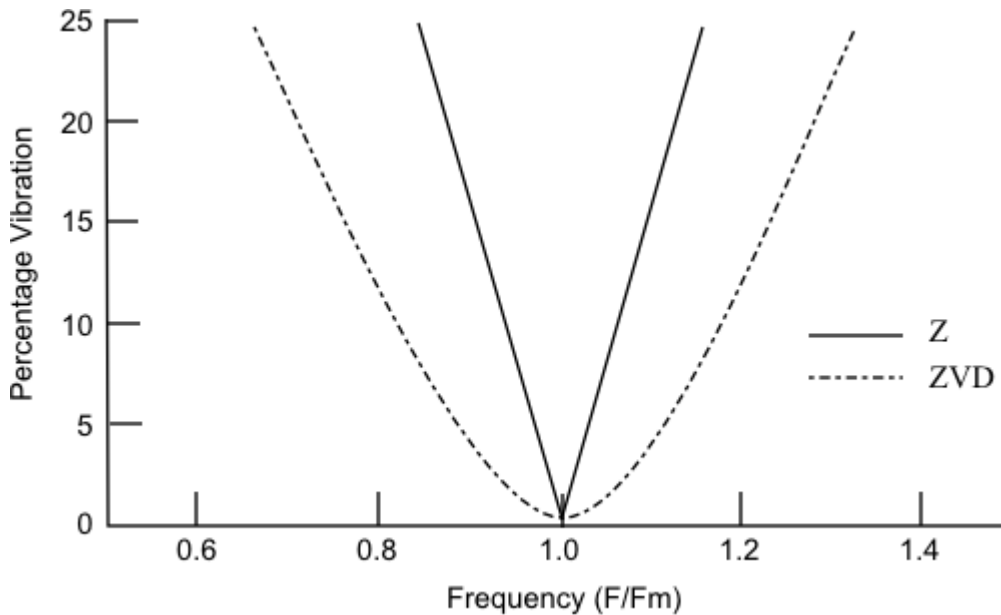

### 17.4.1 Analog

The Analog tab opens a window that shows analog filter choices and a representative curve. Modify the settings as needed and press **Apply**.

## Filters

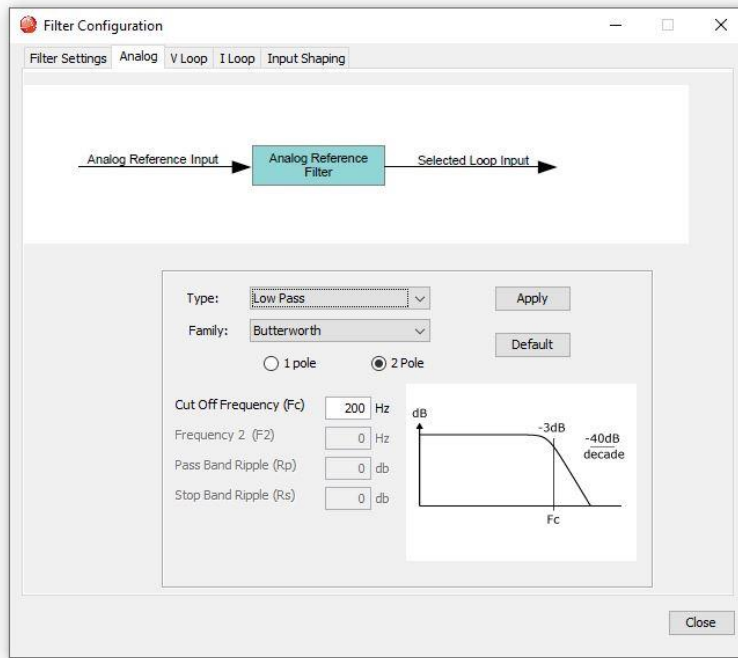

### 17.4.2 Velocity Loop

The V Loop tab opens a window that shows Velocity Loop filter choices and a representative curve. Modify the settings as needed and press **Apply**. Selecting **Default** will supply a 200 Hz Low Pass filter to the first velocity loop output filter.

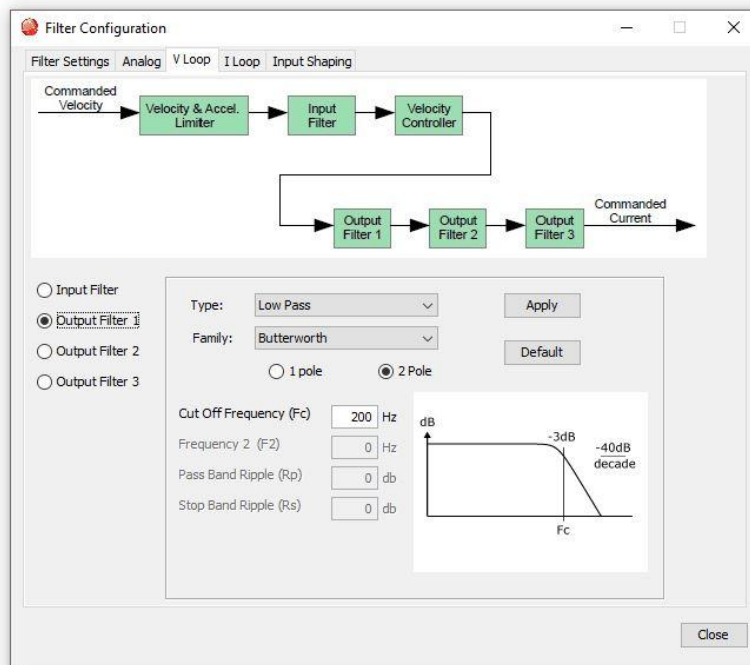

## Filters

### 17.4.3 Current Loop

The I Loop tab opens a window that shows Current Loop filter choices and a representative curve. Modify the settings as needed and press **Apply**.

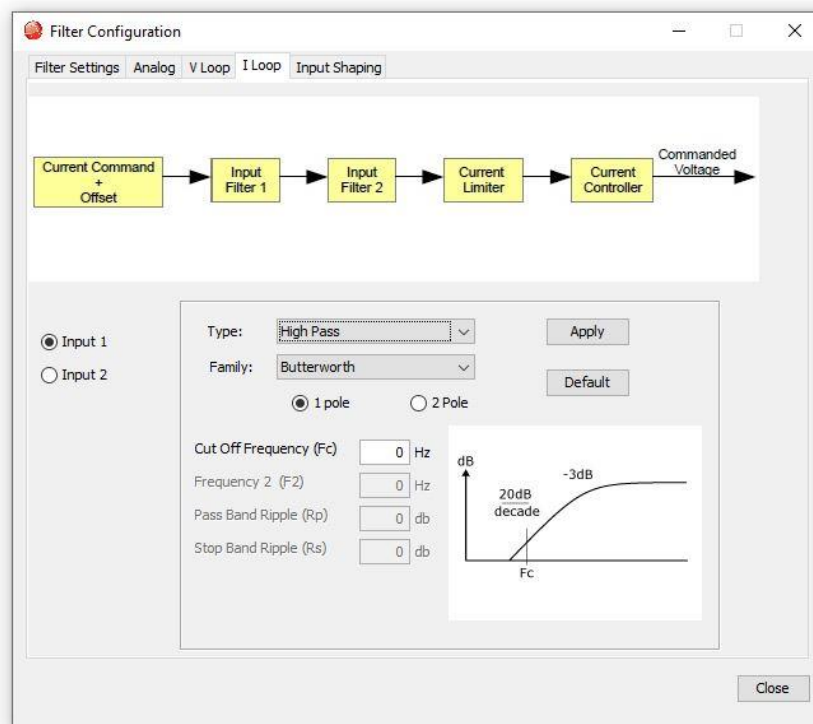

## 17.5 Standard Filter Types

### 17.5.1 Low Pass Filter

Frequencies below the selectable cut-off are allowed to pass.

Example:

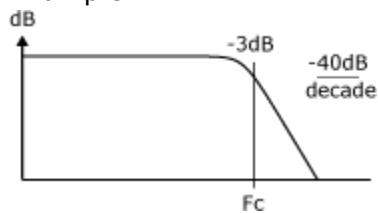

### 17.5.2 High Pass Filter

Frequencies above the selectable cut-off are allowed to pass.

Example:

## Filters

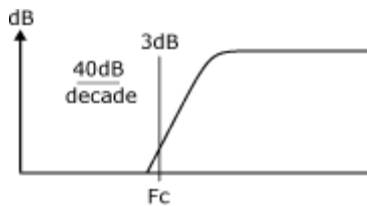

### 17.5.3 Notch Filter

Notch filters allow a bandstop in a range between two selectable frequencies. It may be Butterworth (no ripple), Chebyshev (selectable passband ripple), or elliptical (ripple on both passband and bandstop).

Example:

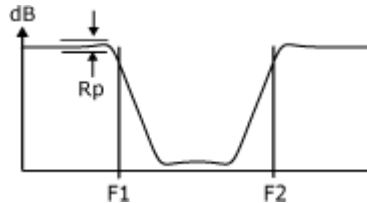

### 17.5.4 Band Pass Filter

Band pass filters allow a range of frequencies, between two selectable cut-offs, to pass. It may be Butterworth, Chebyshev, or Elliptical.

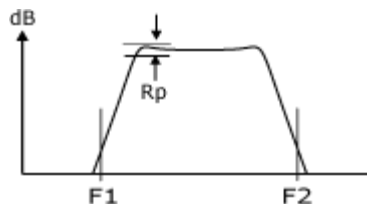

### 17.5.5 Custom Biquad Filter

The Bi-Quadratic filter has two quadratic terms: one in the numerator, and one in the denominator. The numerator affects the filter's two zeros and the denominator affects the filter's two poles. Many filter classes and types can be expressed in the Bi-Quad form by entering the coefficients. The coefficients can be calculated using any commercially available math software package and entered as floating-point numbers. However, due to the fixed-point representation, the numbers may be rounded.

Example:

$$H_{(z)} = \frac{b_0 + b_1 z^{-1} + b_2 z^{-2}}{1 + a_1 z^{-1} + a_2 z^{-2}}$$

## 17.6 Standard Filter Families

### 17.6.1 Butterworth Filter

A Butterworth filter has two poles for faster roll-off at the cut-off frequency.

Example:



## Filters

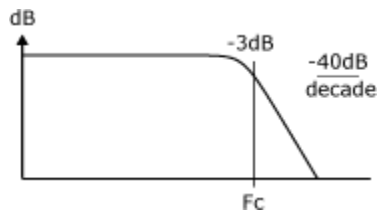

### 17.6.2 Chebychev Filter

A Chebyshev filter has a faster roll-off than a Butterworth filter, but, as a result of the fast roll-off, ripple is introduced into the passband frequency.

Example:

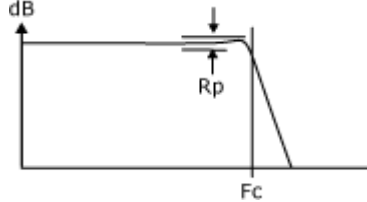

### 17.6.3 Elliptic Filter

Similar to a Chebyshev filter but ripple is introduced into both the passband and the stopband. It has a faster roll-off than a Chebyshev filter.

Example:

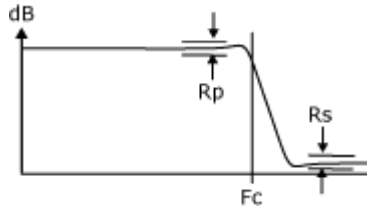

## 17.7 Input Shaping Window

The Input Shaping tab opens a window that shows Input Shaping choices and a representative Time and Amplitude table. Modify the settings as needed and press **Apply**.

Type as well as Frequency and Damping Rate may be adjusted. Overcurrent is adjustable when a Negative Zero Vibration or a Negative Zero Vibration and Derivative filter is chosen. If Custom is chosen as the Type, Time and Amplitude may be set manually.

## Filters

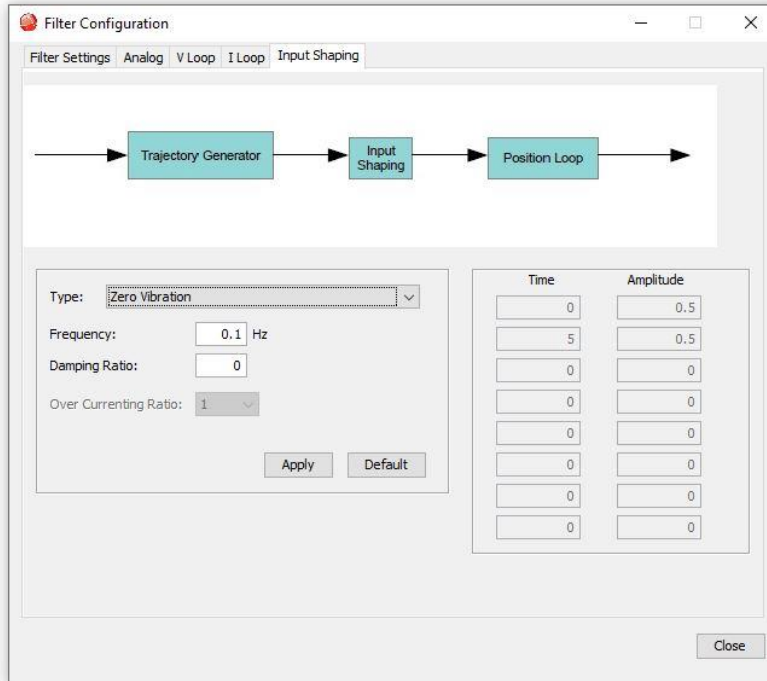

### Input Shaping Types

Type	Description
Zero Vibration	Single step inputs are replaced with two step inputs of smaller magnitude. One of which is delayed by one-half the period of vibration. Sensitive to some modeling errors.
Zero Vibration and Derivative	A zero derivative (of the vibration) constraint is added to Zero Vibration impulse shaping, thereby reducing modeling errors.
Negative Zero Vibration	Faster than positive input shaping (Zero Vibration, and Zero Vibration and Derivative), but may magnify high frequency vibrations.
Negative Zero Vibration and Derivative	A zero derivative (of the vibration) constraint is added to Negative Zero Vibration impulse shaping.
Custom	Time and Amplitude can be set manually.

## 17.8 Measuring Mechanical Vibration

There are several ways to measure mechanical vibration. Two choices are offered below.

### 17.8.1 Using an Accelerometer with CME

Begin with a Copley drive operational and controlled by CME .

1. Connect the accelerometer analog output to Copley drive's Analog + and - on the signal input as in the diagram below.

## Filters

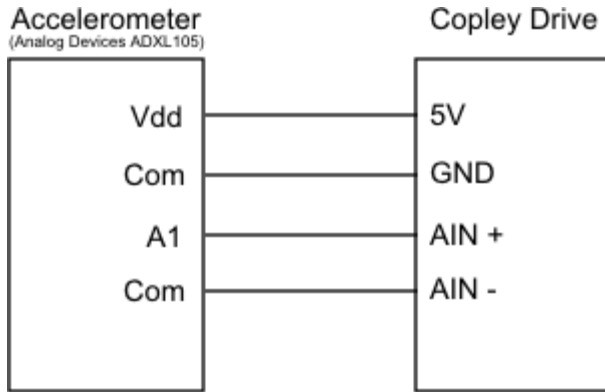

2. On CME , click the Scope Tool .
3. Select the Measurement tab, choose a channel, select Voltage, then Analog Command.
4. Perform a move.
5. After the move is complete, measure  $T_m$  ( $1/F_m$ ), which is the period of mechanical oscillation.

### 17.8.2 Using CME to Monitor Following Error

Monitor the following error using CME 's scope option.

Begin with a Copley drive operational and controlled by CME .

1. On CME, click the Scope Tool .
2. Select the Measurement tab, choose a channel, select **Position**, then **Following Error**.
3. Perform a move.
4. After the move is complete, measure  $T_m$  ( $1/F_m$ ), which is the period of mechanical oscillation.

# 18 FREQUENCY ANALYSIS

## 18.1 Overview

The Frequency Analysis screen expands on the functionality of CME by providing a tool to measure the frequency response of a system while running a sine sweep. This further enhances the ability to tune and troubleshoot systems, particularly when there is a mechanical resonance present. The frequency analysis tool will measure and plot the current/velocity loop frequency response on a semi-log graph.

Click  to open the Frequency Analysis screen.

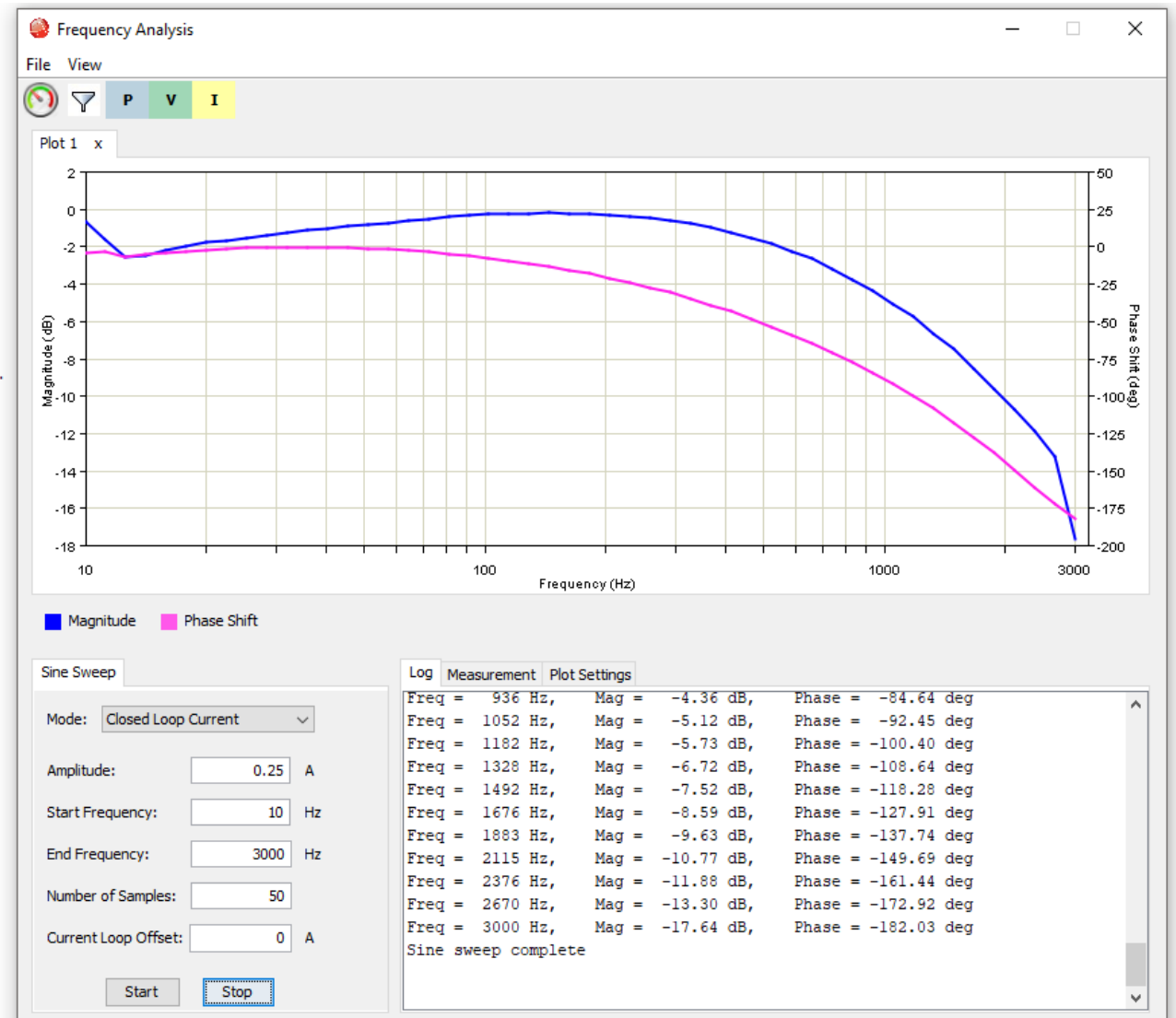

## 18.2 User Interface

### 18.2.1 Graph

The frequency response data is plotted on a semi-log graph when the sign sweep completes. Each time a sine sweep is run, the data is plotted on a graph in a new tab. The tabs are named with the plot number (Plot 1, Plot 2, etc.). For multi-axis drives, the axis letter is appended to the tab name (e.g. Plot 1A, Plot 2B, etc.). The magnitude scale is displayed on the left Y axis and the phase shift scale is displayed on the right Y axis.

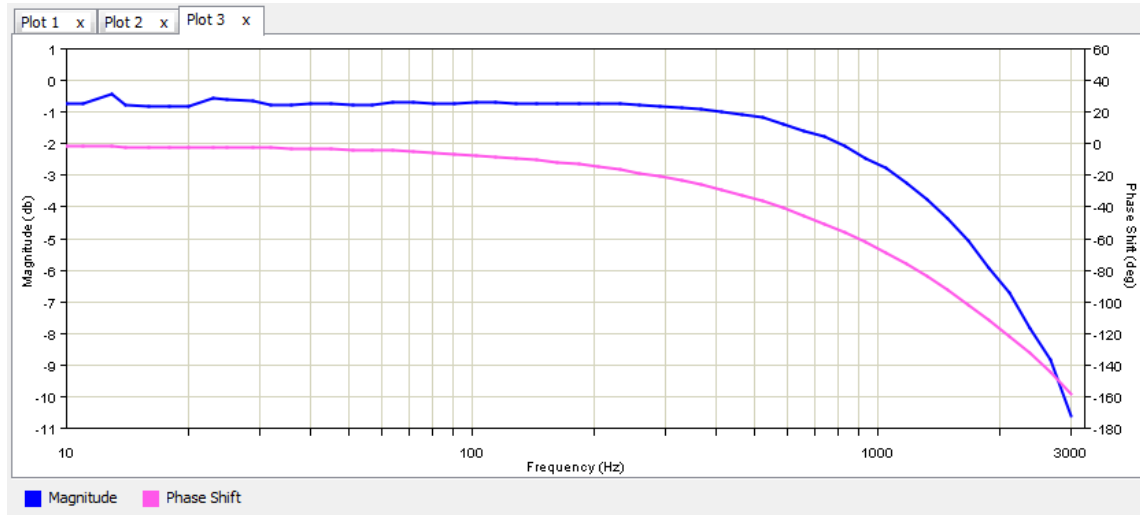

### 18.2.2 Graph Options Menu

To display the plot options menu, right-click anywhere on the graph.

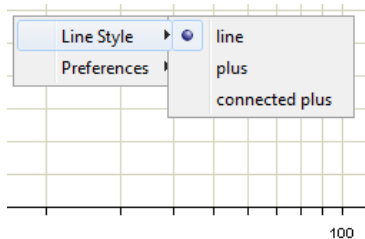

Menu	Menu Items	Description
Line Style	line	A line connects the plotted data points.
	plus	The Scope plots data points as plus signs, with no connecting line.
	connected plus	Data points are plotted as plus signs and relate to a line.
Preferences	anti-aliasing	When anti-aliasing is selected, the Scope removes screen-related jaggedness in the displayed trace. Use of this feature may slow down the refreshing of traces on slow computers.
	grid	When selected a grid is displayed on the scope screen.

# Frequency Analysis

## 18.2.3 Sine Sweep Controls

Sine Sweep

Mode: Closed Loop Current

Amplitude: 0 A

Start Frequency: 10 Hz

End Frequency: 3000 Hz

Number of Samples: 50

Start Stop

### Mode

Description: The loop to which the excitation will be applied, and the response will be measured. The options are Closed Loop Current, Closed Loop Velocity, Open Loop Velocity, Open Loop Velocity Plant, Open Loop Velocity Controller and Open Loop Position

Units: None

Default: Closed Loop Current

### Frequency Analysis: Closed Loop Current

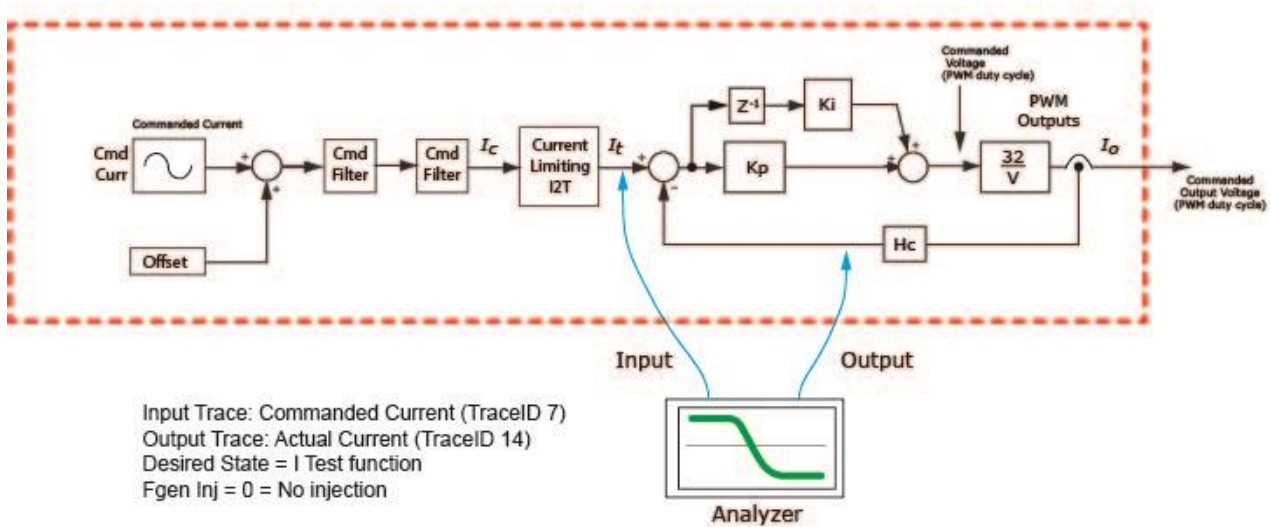

### Frequency Analysis: Closed Loop Velocity

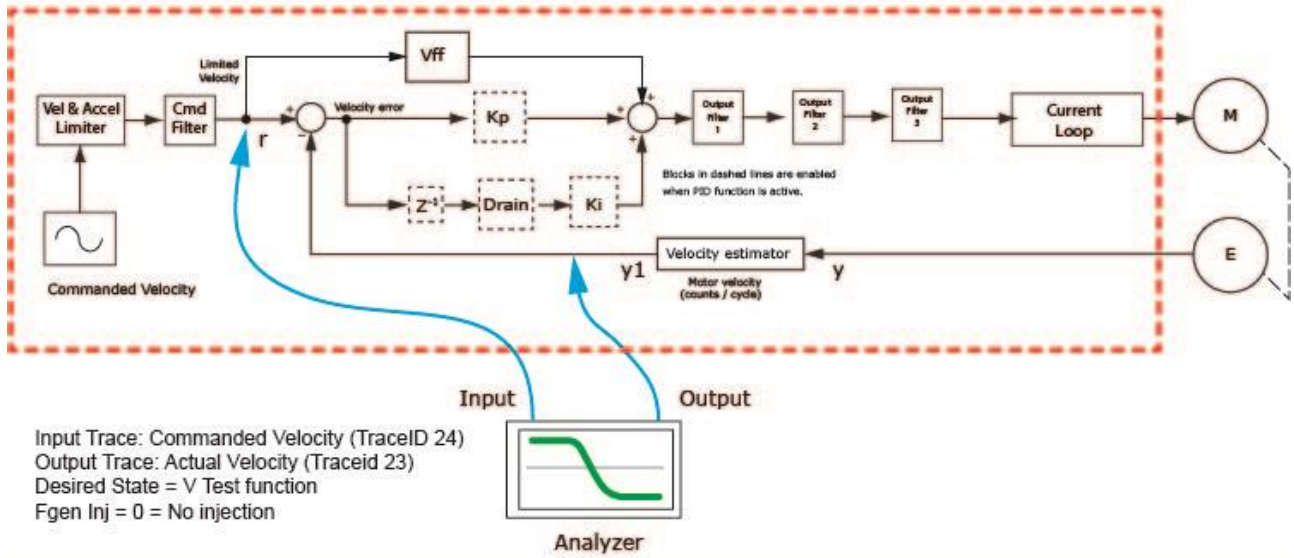

### Frequency Analysis: Open Loop Velocity

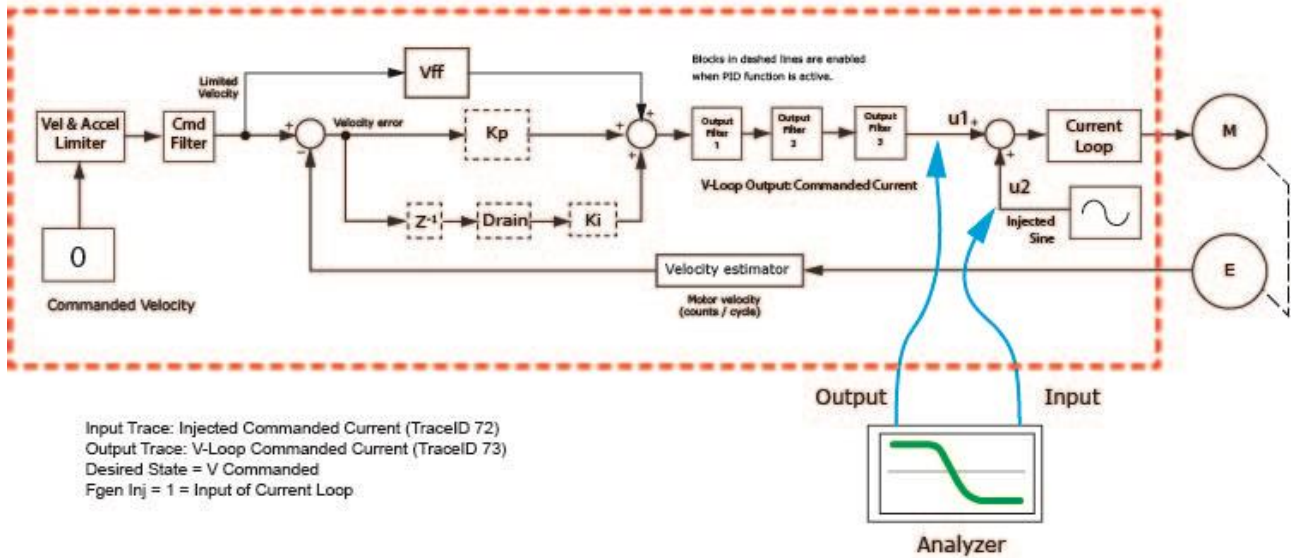

### Frequency Analysis: Open Loop Velocity Plant

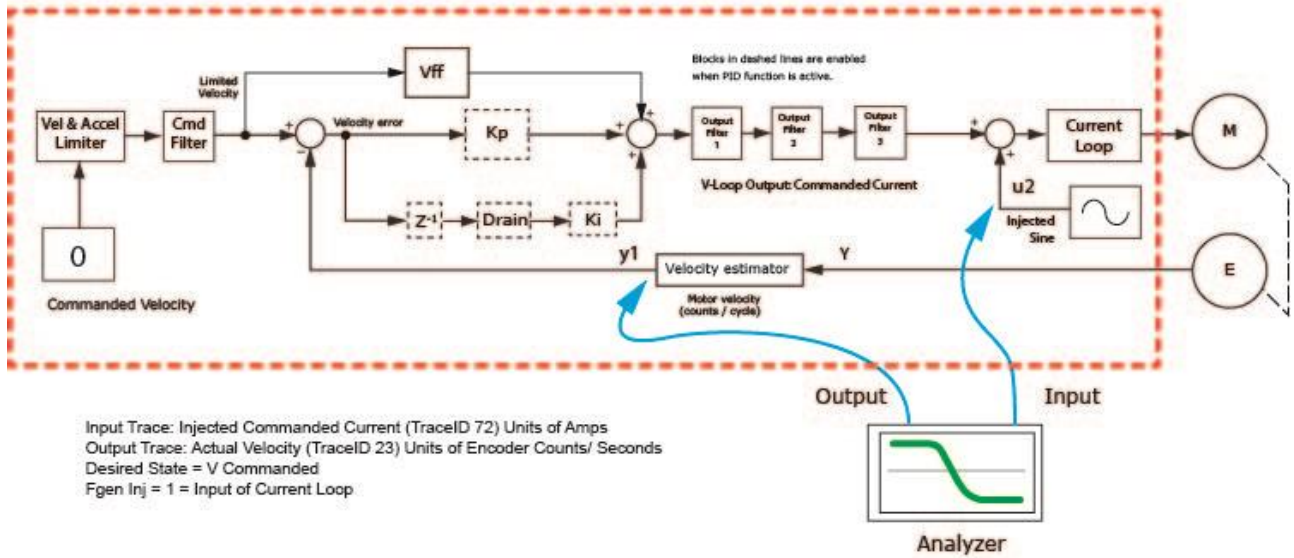

### Frequency Analysis: Open Loop Velocity Controller

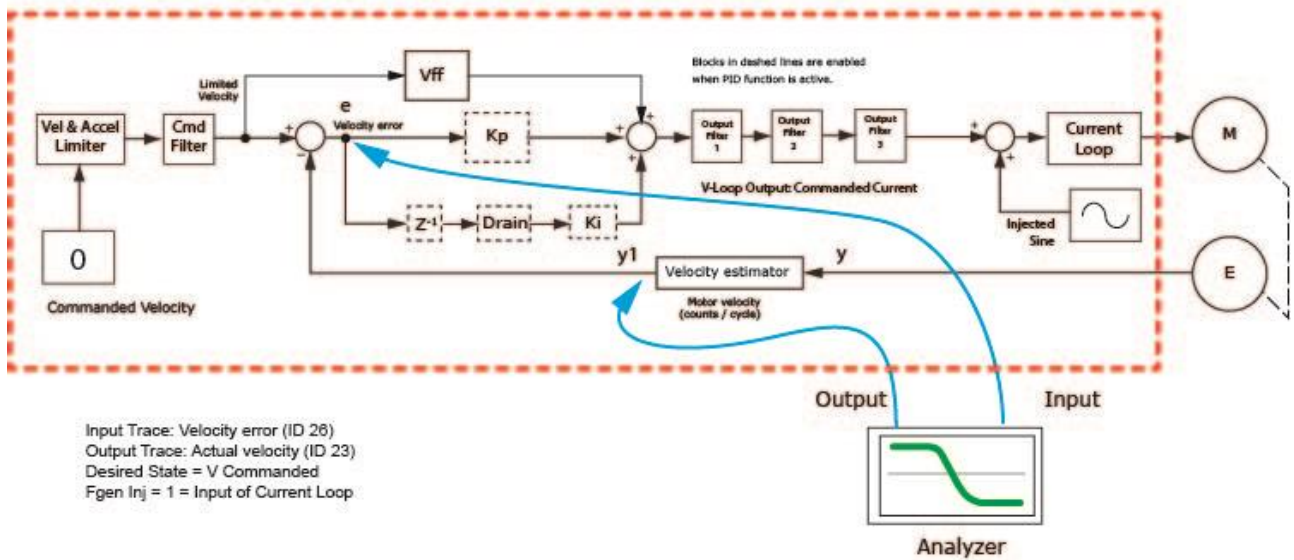



### Frequency Analysis: Open Loop Position

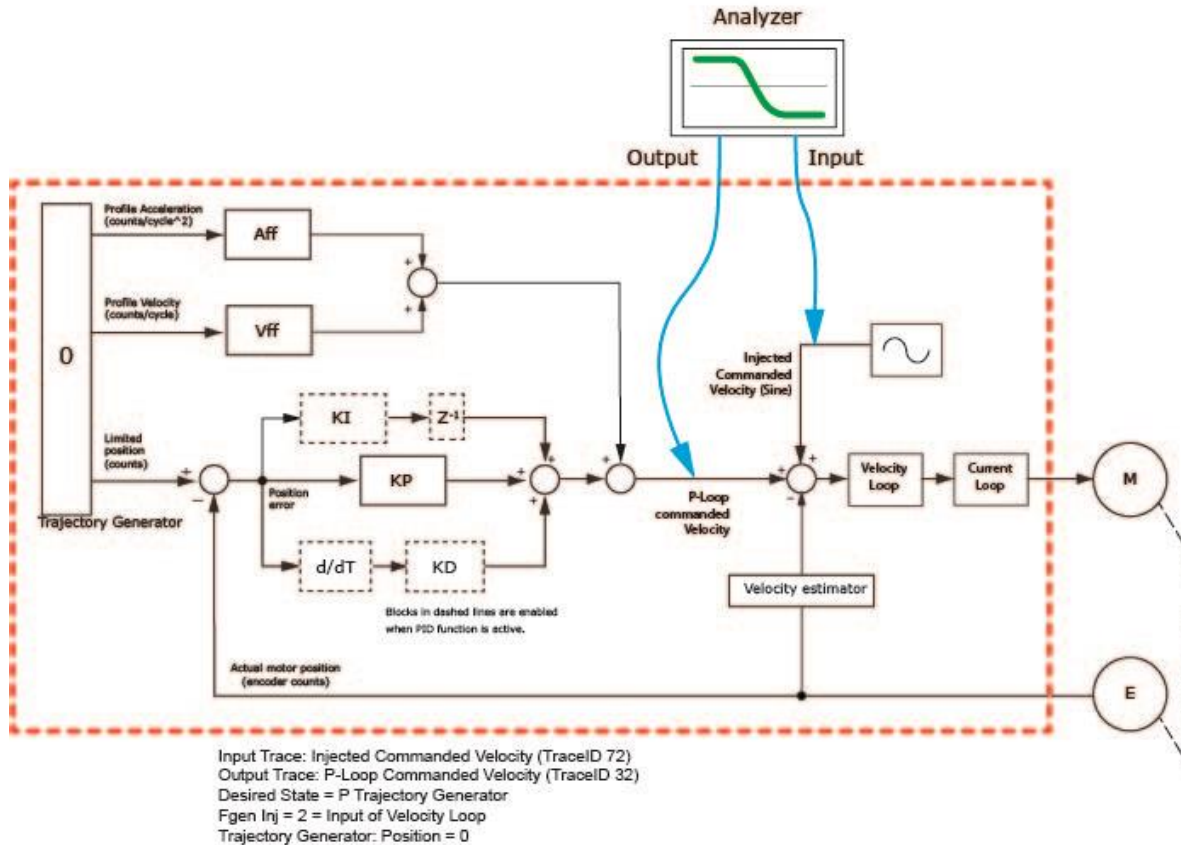

#### Amplitude

Description: The amplitude of the sine wave.  
 Units: A (current), rpm (velocity, rotary motor), mm/s (velocity, linear motor).  
 Default: Current: 10% of the current loop continuous current.  
 Velocity: 5% of the velocity loop velocity limit.

#### Start Frequency

Description: The first frequency of the sine sweep.  
 Range: 0.1 to 9999 Hz  
 Units: Hz  
 Default: Current: 10 Hz,  
 Velocity: 5 Hz

#### End Frequency

Description: The last frequency of the sine sweep.  
 Range: 0.2 to 10000 Hz  
 Units: Hz  
 Default: Current: 3000 Hz  
 Velocity: 250 Hz

## Frequency Analysis

### Number of Samples

Description: The number of sine wave frequencies to run during the sine sweep. The frequencies are calculated so that there are an equal number of frequencies per decade.

Range: 2 to 100

Units: None

Default: 50

### Start

Description: Starts the sine sweep.

Units: N/A

Default: N/A

### Stop

Description: Cancels the sine sweep in progress.

Units: N/A

Default: N/A

### 18.2.4 Log Text Window

The log text window shows the progress of the sine sweep. For each frequency, the measured frequency response (magnitude and phase shift) is displayed. These are the values that get plotted in the graph.

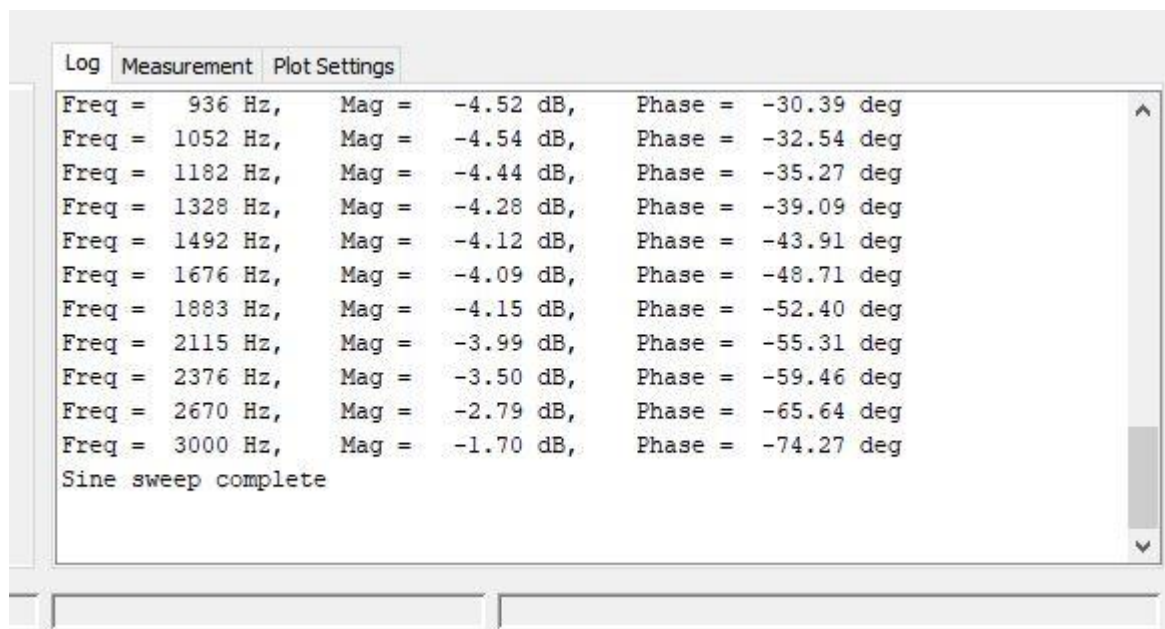

## Frequency Analysis

### 18.2.5 Measurement

The Measurement tab contains tools to analyze the data displayed on the graph.

#### Cursors

Select  Show Cursors to display the cursors on the graph.

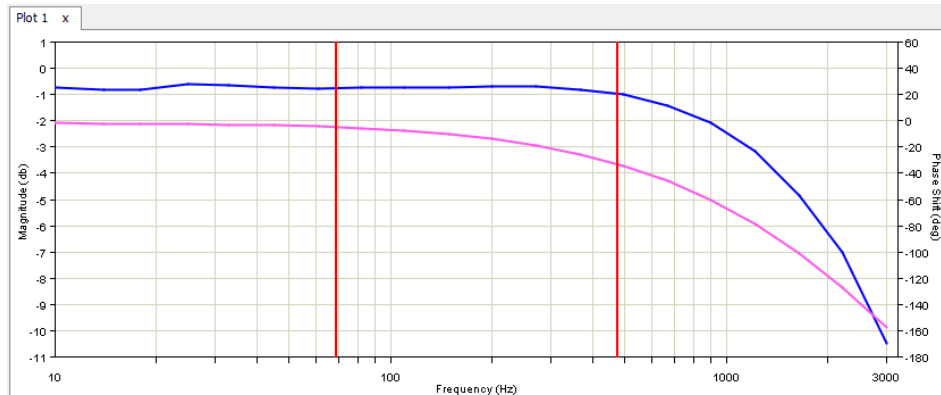

To move the cursors, left-click a cursor and drag it to the left or right. As the cursor is moved along the plot, the values for Frequency, Magnitude, and Phase Shift are updated in the Measurement tab.

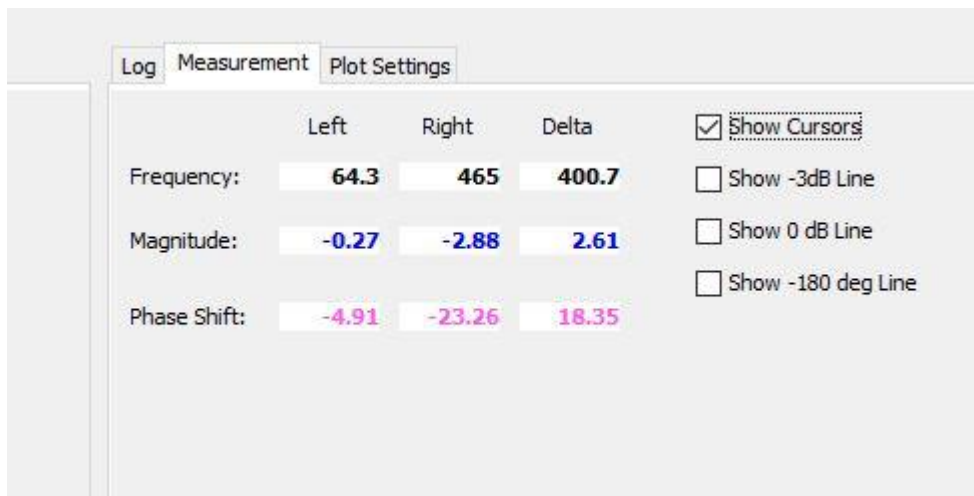

#### 18.2.5.1 Show -3db Line

Select  Show -3db Line to display a horizontal dashed line where the magnitude is -3db. The -3db point on the magnitude plot is used to determine the bandwidth of the system.

## Frequency Analysis

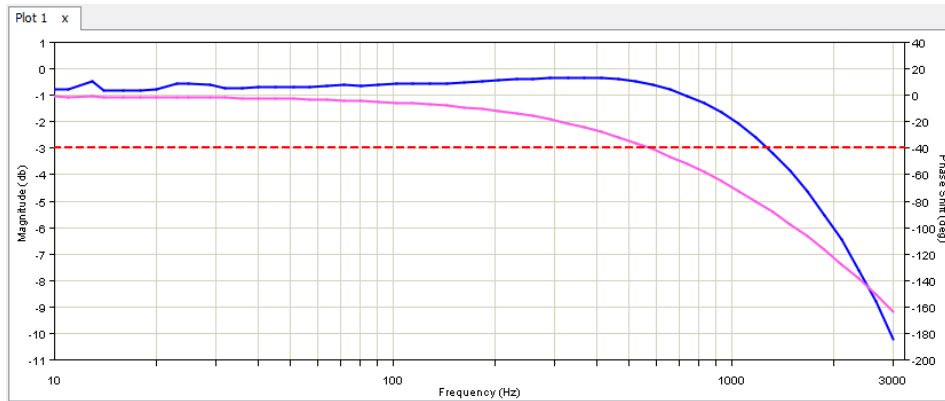

### 18.2.5.2 Show -180 degree Line

Select  Show -180 Line to display a horizontal dashed line where the phase shift is -180 degrees. This line is useful for determining the phase and gain margins of your system.

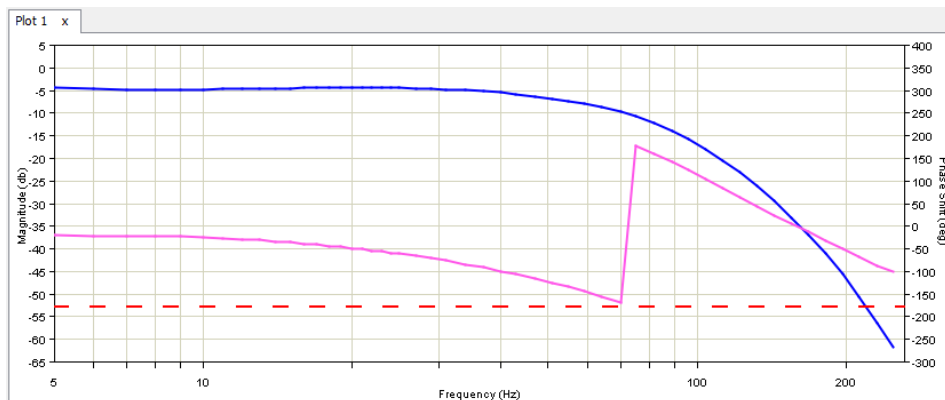

### 18.2.5.3 Manually measuring gain margin

Assuming the phase starts at 180 deg and goes to 0 deg (a phase shift of 180 deg), measure the gain margin from 0 db at this phase inversion and determine how many decibels of gain margin exist. A critically damped loop may have approximately 15 db of gain margin.

### 18.2.5.4 Manually measuring phase margin

Assuming the phase starts at 180 deg and goes to 0 deg, (a phase shift of 180 deg), measure the phase shift at the 0 db gain from the initial phase to the new phase to determine the phase margin. A critically damped loop may have approximately 75 db of phase margin.

## Frequency Analysis

### 18.2.6 Plot Settings

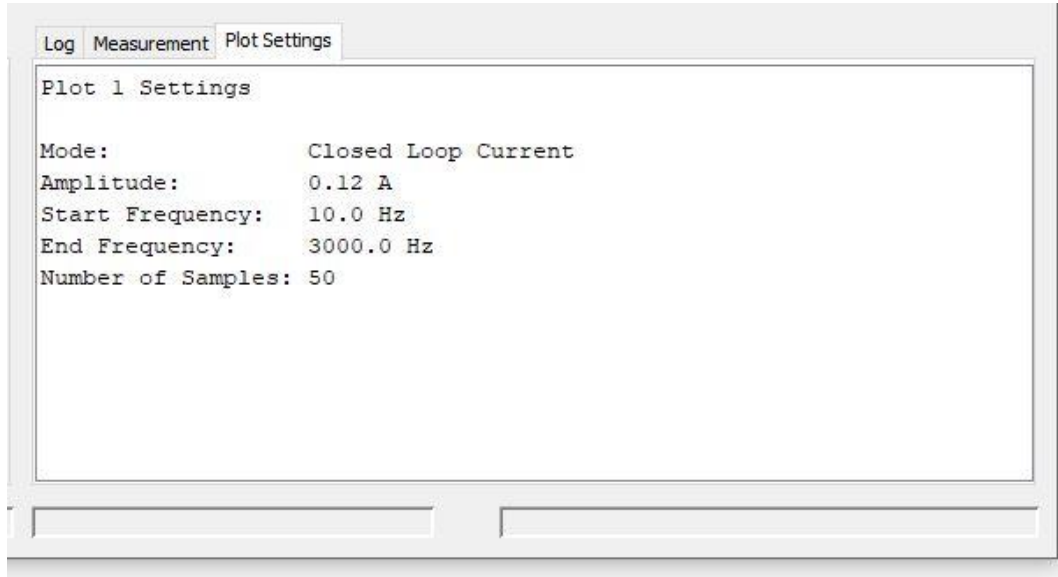

### 18.2.7 File Menu

 Frequency Analysis

File View

File Menu Items	Description
Save Current Plot	Saves the data from the sine sweep of the plot currently displayed in a csv format that can be imported to other software such as spreadsheets or mathematical analysis programs.

### 18.2.8 Filter Screen

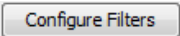
Click  to open the Filter Configuration screen.

### 18.2.9 Status Bar

The left and middle text fields of the Status Bar show various faults and warnings while the Frequency Analysis screen is open.

#### 18.2.9.1 Faults/Warnings Status

The left text field of the status bar shows the faults and warnings. Faults will be displayed with a red background and warnings will be displayed with a yellow background. Only two warnings are monitored during frequency analysis: Current Limited Warning and Voltage Limited Warning. All faults are monitored during frequency analysis.



### **18.2.9.2 Motion Inhibited Status**

The middle text field of the status bar shows the conditions that will prevent motion. The conditions that are not faults, but will prevent motion are:

- Positive and negative software limits
- Positive and negative limit switches
- Drive is disabled by hardware (enable input not active).
- Phase not initialized (only applies when feedback is set up for phase initialization).



## 19 DATA, FIRMWARE, AND LOGS

### 19.1 Amplifier RAM and Flash Memory

#### 19.1.1 Amplifier RAM

- Volatile. Contents erased when amplifier is reset or powered off.
- Initial contents read from flash on power-up. Contents then updated in real time to reflect certain operational conditions and changes entered with CME software. At any time, the user can use CME to restore data from flash into amplifier RAM.

#### 19.1.2 Flash

- Non-volatile. Contents retained when the amplifier is reset or powered off.
- Modified only by using a **Save to Flash** tool or by closing certain screens (Motor, Setup, Homing, or CAN Configuration), whose contents are automatically saved to flash upon closing of the screen.

Parameters reside in RAM only, Flash only, or both RAM and Flash. The table below illustrates the typical parameter locations. Refer to the Parameter Dictionary for information about specific parameters.

Data Resides In	Data
Flash only	This category includes all Motor/Feedback screen data and Setup screen (motor/feedback data only). This data is saved to flash when the user confirms the values and closes the screens without cancelling.
Amplifier RAM only	Includes operating status data such as actual position, actual current, and amplifier temperature. Such data is never stored in flash. It is destroyed from amplifier RAM with each power-down or amplifier reset.
Flash and amplifier RAM	Includes all other data not represented in the two categories above. When changing these parameters in CME, the value is saved to amplifier RAM only. To save these values to flash, the Save To Flash operation must be performed or data will be lost on power down or reset.



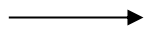

### 19.2 Data Management Tools

#### 19.2.1 Amplifier

Operations performed using the amplifier data management tools at the top of the Main screen (shown below) affect amplifier settings, including motor/feedback data. (CVM Control Program data is not saved by these operations).







Data Management Tools

Action	Name	Description
	Save amplifier data to disk	Saves both amplifier and motor/feedback data to a disk with a .ccx filename extension.
	Restore amplifier data from disk	Restores amplifier and motor/feedback data from a .ccx file to the amplifier's RAM, or flash for the flash only variables. See Parameter Dictionary for parameter descriptions. A To Flash operation should be performed to insure that all data is saved to flash
	Save amplifier data to flash	Saves contents of amplifier RAM to amplifier flash memory.
	Restore amplifier data from flash	Restores contents of amplifier flash memory to amplifier RAM.

### 19.2.2 Motor/Feedback Screen

Operations performed using the Motor screen data management tools only apply to the motor parameters.



Action	Name	Description
	Save motor data to disk	Saves only motor data to disk with a .ccm filename extension. Amplifier data that is not represented on the Motor screen is not saved in this file.
	Restore motor data from disk	Restores only motor data from a disk file with a .ccm filename extension amplifier flash (the motor parameters are flash only).
	Save motor data to flash	Saves the contents of the Motor screen from to amplifier flash memory. Amplifier data that is not represented on the Motor screen is not saved. Can be used to assure that all changes are saved to flash without closing the Motor screen.
	Restore motor data from flash	Restores only motor data from amplifier flash memory to the PC. Amplifier data that is not represented on the Motor screen is not affected. Can be used before closing the Motor data screen to restore settings to the previously saved values.

## 19.3 Multi-Axis Data Tools

The descriptions in this section only apply to multi-axis drives (XE2, BE2, etc.).

### 19.3.1 Copy Axis

CME allows one axis to be copied to another. This feature allows quick set up of multiple axes, since only one axis needs to be set up. The Copy Axis operation copies all RAM/Flash and Flash Only parameters to the other axis.



## Data, Firmware and Logs

From the menu on the Main screen, select **File→Copy Axis**. This will display the Copy Axis screen:

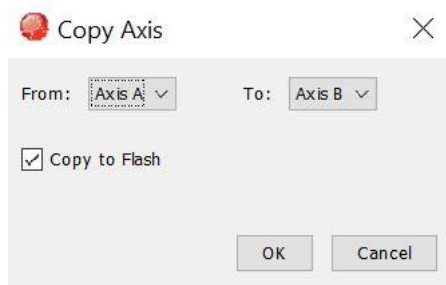

Select the source and destination axes, then click **OK**. Note that Copy to Flash is selected by default. If this option is not selected, then the RAM/Flash parameters will only be copied to the destination axis' RAM, while still copying the Flash Only data to the destination axis' Flash.

### 19.3.2 Save/Restore Single Axis

CME allows a single axis of data to be saved/restored on a multi-axis drive. This feature is useful when one axis of tuning/setup data is common across many multi-axis drives, but only on one axis. The file will be saved as a .ccx file. Restoring a .ccx file to a single axis, the file must be written as a single axis, otherwise an error will be displayed.

From the menu on the Main screen, select **File→Save As→Single Axis**. This will display the Save Single Axis screen. Select the axis to be saved, click **OK**, and then continue with naming and saving the file.



From the menu on the Main screen, select **File→Restore→Single Axis**. This will display the Restore Single Axis screen. Select the axis to restore the file data to, click OK, then browse to the single axis file.

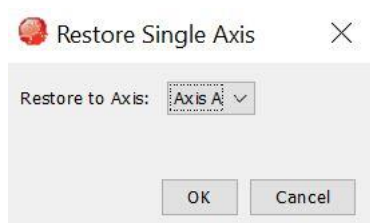

## 19.4 Drive Configuration

The Plus Family of drives have the capability of saving/restoring the entire drive configuration to a file. The drive configuration consists of all parameters (RAM/Flash and Flash Only) and the entire contents of the CVM flash, which includes any CVM programs, cam tables, and gain scheduling tables. The file is saved with a .ccd file extension.

This feature is useful to clone drives in one step rather than separately loading each file (.ccx, .ccp, .cct, .ccg). Additionally, the file is in XML format which can be read by some EtherCAT masters as an ESI file for File over EtherCAT (FOE).

### 19.4.1 Save Drive Configuration

From the menu on the Main screen, select **File→Save Drive Configuration**, then choose a filename. A progress bar will be displayed while the data is being saved to the file.

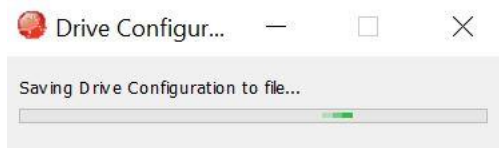

### 19.4.2 Restore Drive Configuration

From the menu on the Main screen, select **File→Restore Drive Configuration**, then choose a filename. A progress bar will be displayed while the data is being saved to the file

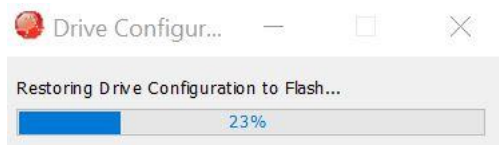

All the data read from the file is saved to the drive's Flash. After all the data is written, the drive will be reset, so that the Flash data is copied to RAM.

## 19.5 Copy Drive Data

In product families prior to the Plus Family, the [Drive Configuration](#) feature is not available. To clone one drive to the next, multiple steps are required.

1. Load the .ccx file:

From the Main screen, click **Restore**  **→ Amplifier Data (.ccx)**.

## Data, Firmware and Logs

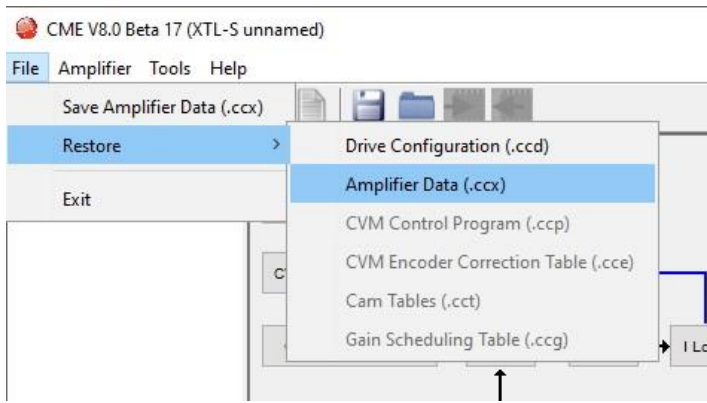

OR From the **Setup** screen, click **Load ccx File**.

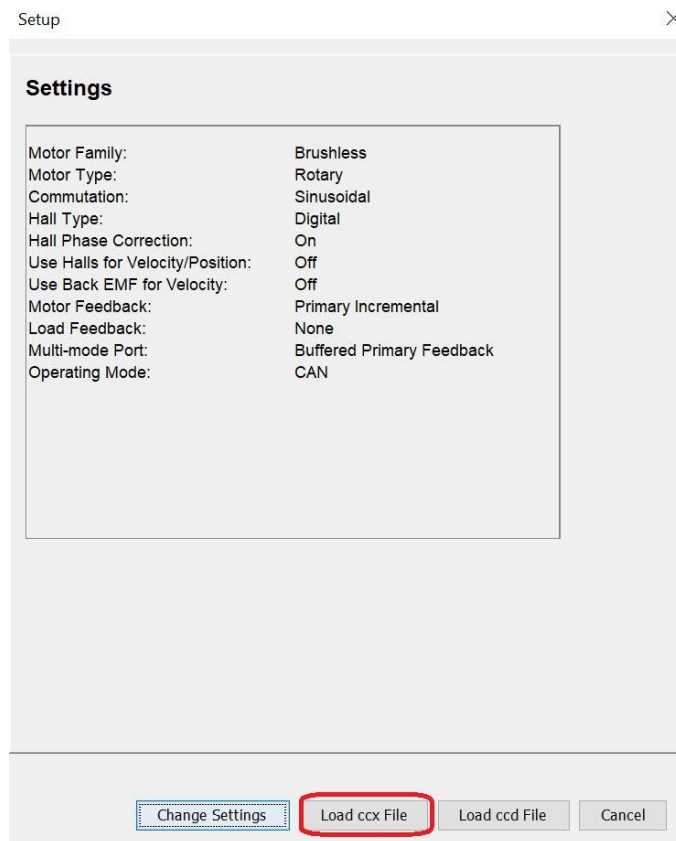

When prompted browse to the folder containing the .ccx file and open it.

On the Main screen, click **Save to Flash**  to save the new settings to flash memory.

2. Load the .ccd file:

From the Main screen, click **Restore**  → **Drive Configuration (.ccd)**.

## Data, Firmware and Logs

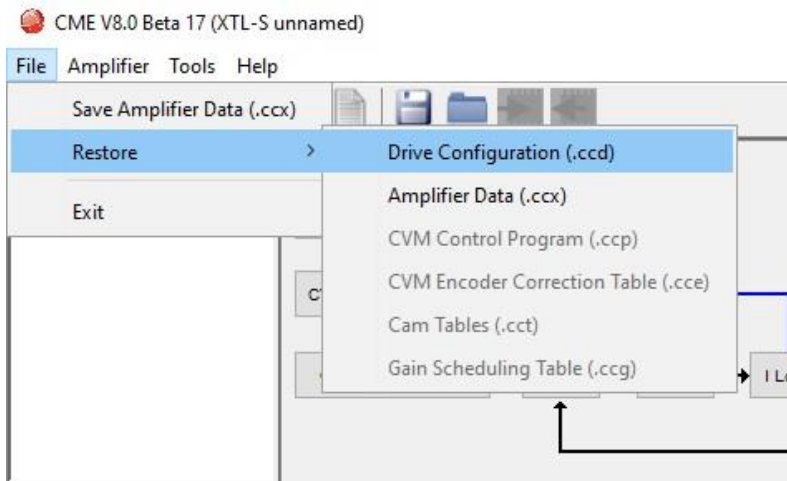

OR From the Setup screen, click **Load ccd File**.

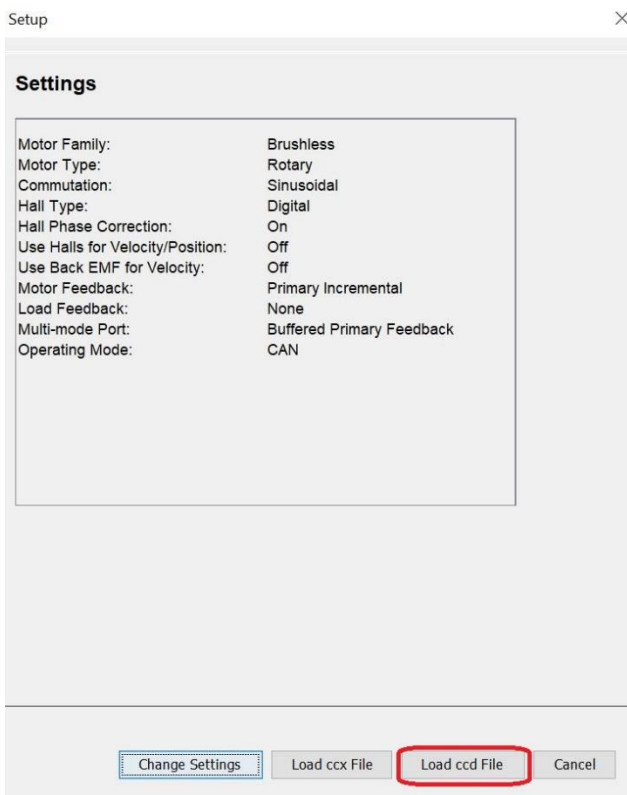

When prompted browse to the folder containing the .ccd file and open it.

On the Main screen, click **Save to Flash**  to save the new settings to flash memory.

3. Load a CVM program .ccp file:

From the menu on the Main screen, choose **File→Restore→CVM Control Program**. When prompted, navigate to the folder containing the appropriate .ccp file and open it.

This procedure also results in setting the Enable Control Program on Startup option, which configures the program to auto start when the amplifier is powered up or reset.

4. Load Cam Table .cct files:

From the menu on the Main screen, choose **File→Restore→Cam Tables**. When prompted, navigate to the folder containing the appropriate .cct file and open it.

5. Load Gains Scheduling Table .ccg files  
From the menu on the Main screen, choose File→Restore→Gains Scheduling Tables.  
When prompted, navigate to the folder containing the appropriate .ccg file and open it.

**TIP:** When copying amplifier data to multiple amplifiers in a production environment, consider locking CME to prevent accidental changes to settings. See [Lock/Unlock CME](#).

## 19.6 Save MACRO File for Delta Tau Controllers

This feature is available only on Copley MACRO drives such as the XML Xenus MACRO

1. On the CME Main screen, choose **File→Save MACRO File** to open the MACRO File Save window:

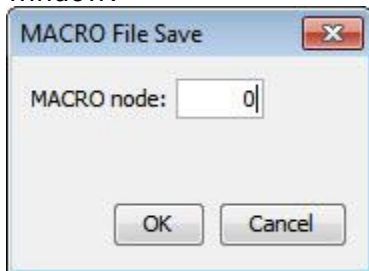

2. Enter the ID of the MACRO node with the settings you want to save and click **OK**.
3. When prompted, enter a File Name. If needed, navigate from the default AmpData folder to another folder where you wish to store the file.
4. Click **Save** to save the .pmc file in the same folder and close the screen.

## 19.7 Lock/Unlock CME

The Lock feature of CME is used to lock out most screens to prevent data from being changed.

WHEN CME IS LOCKED:

- User cannot change any amplifier or motor settings.
- User can download amplifier and motor files and Cam Tables, jog the motor, run scope functions and profiles, and monitor amplifier performance with the scope and control panel.

1. On the Main screen choose **Tools→CME Lock/Unlock**.
2. Set a new password in the Password and Verify Password fields.



3. Click **OK** to lock out amplifier setting controls.

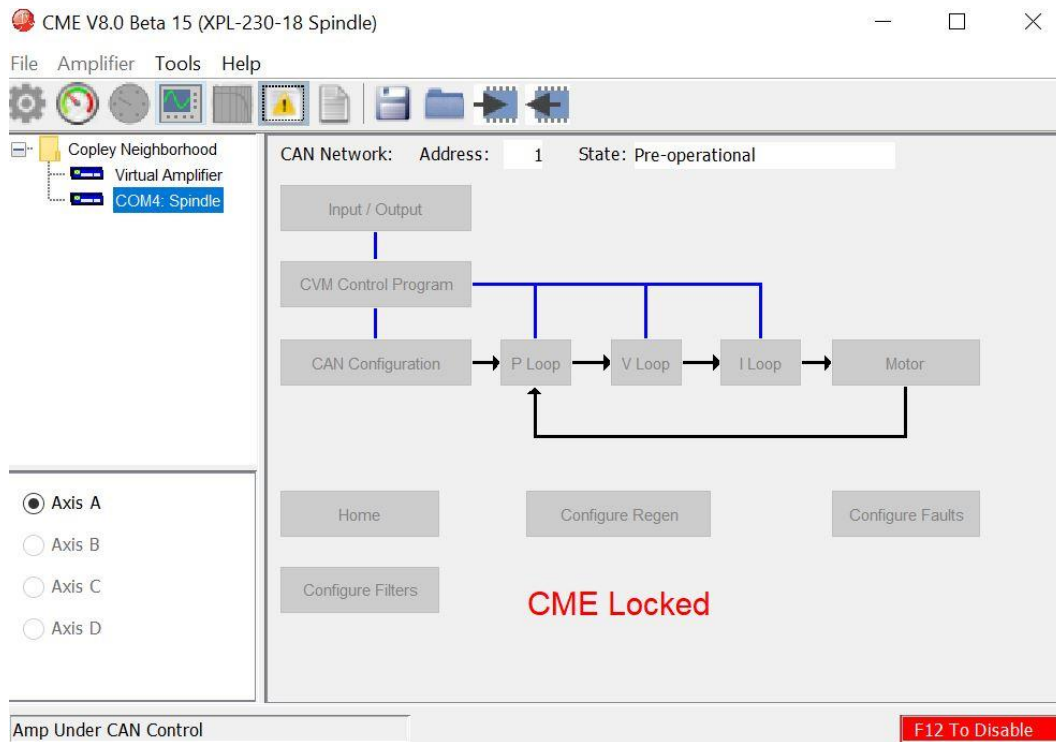

4. To unlock, choose **Tools**→**CME Lock/Unlock**.



Enter the password. Click **OK**

## 19.8 Firmware Download

The amplifier’s flash memory holds the amplifier’s firmware. As needed, perform the following steps to obtain new firmware and download it to amplifier flash memory.

### NOTES:

- CME does not support downloading firmware to a node amplifier via a multi-drop gateway amplifier; a direct connection (serial, CAN, EtherCAT) must be used.
- To check the firmware version currently loaded, click the **Amplifier Properties** button or choose **Help**→**About**.

## Data, Firmware and Logs

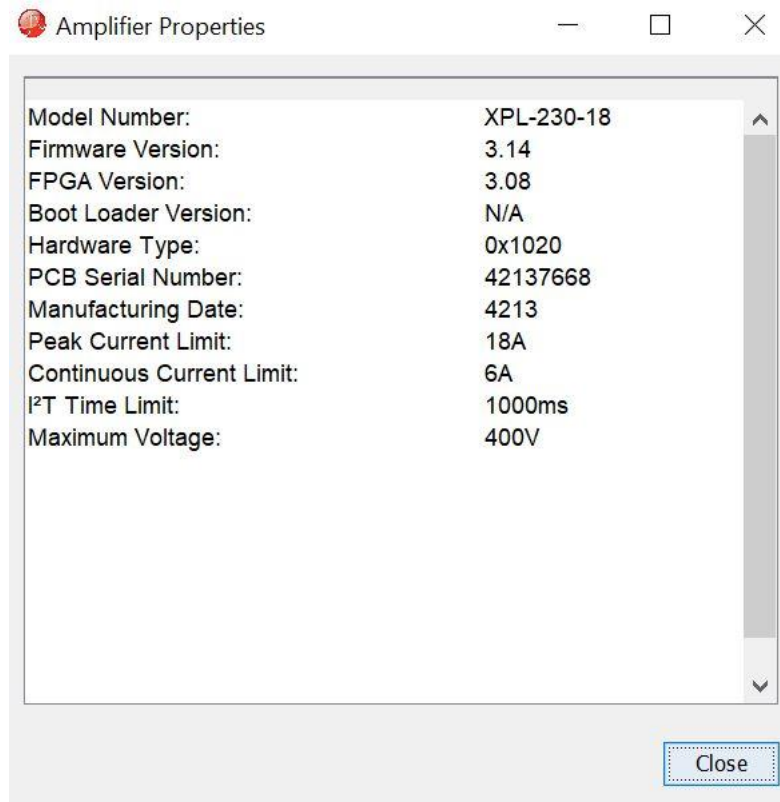

**WARNING: Do not power down or disconnect the amplifier during firmware download.**

On the Main screen choose **Tools**→**Download Firmware** to open the Download Firmware window. Browse to where the firmware file is located and click **Open** to start the download. The progress will be displayed while downloading.

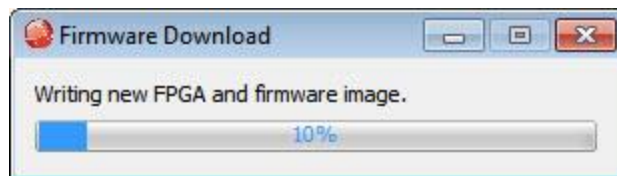



When the progress dialog closes, the firmware download is complete.

## 19.9 Error Log

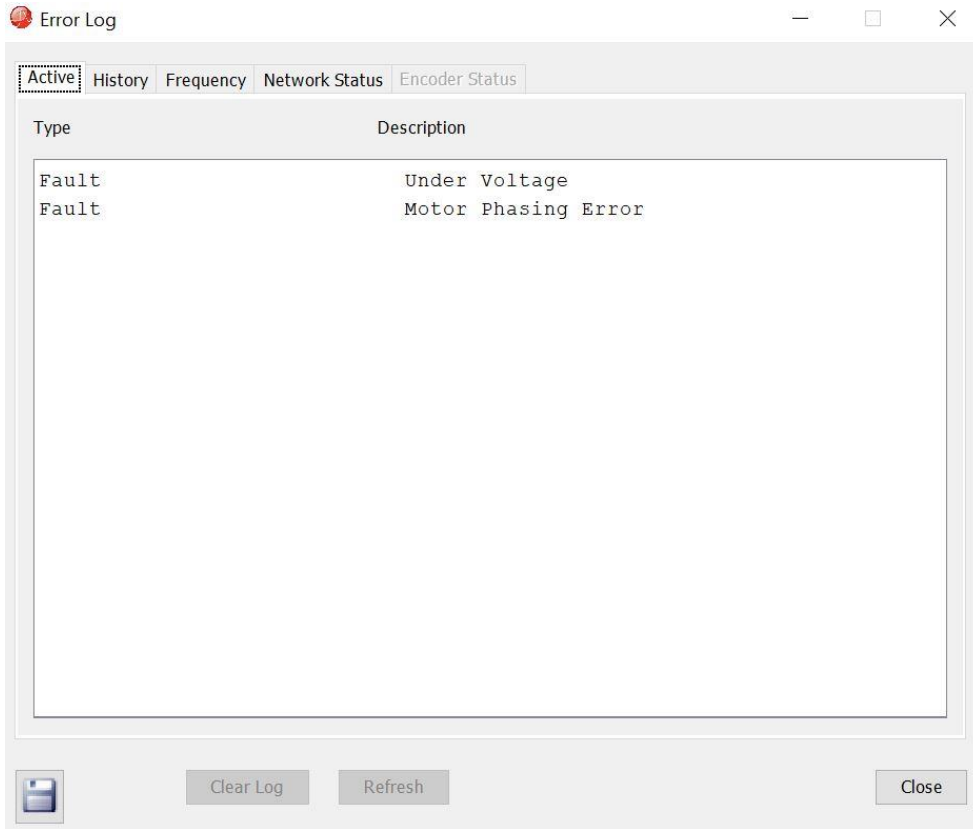
Click the **Error Log** tool  on the Main screen

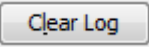

<b>Tab</b>	<b>Contents</b>
Active	Type and description of each active fault and warning. The contents of this tab are automatically refreshed as new events occur.
History	Type, description, and time of occurrence of each fault and most warnings since the log was last cleared. The contents of this tab are not refreshed automatically as new events occur. The contents are refreshed only when the tab is displayed or when <b>Refresh</b> is clicked.
Frequency	Type, description, and frequency of each fault and warning that has occurred since the log was last cleared. The contents are refreshed only when the tab is displayed or when <b>Refresh</b> is clicked.
Network Status	(Under CAN control only.) Status of CANopen network. Lists warnings and errors.
Encoder Status	Reads the encoder status
	Saves the contents of the History and Frequency tabs to a text file.
	Clears all History and Frequency entries in the drive
	Updates the contents of the History or Frequency tabs



## 19.10 Amplifier Properties

This screen provides the general information including the hardware type, firmware etc. of the drive.

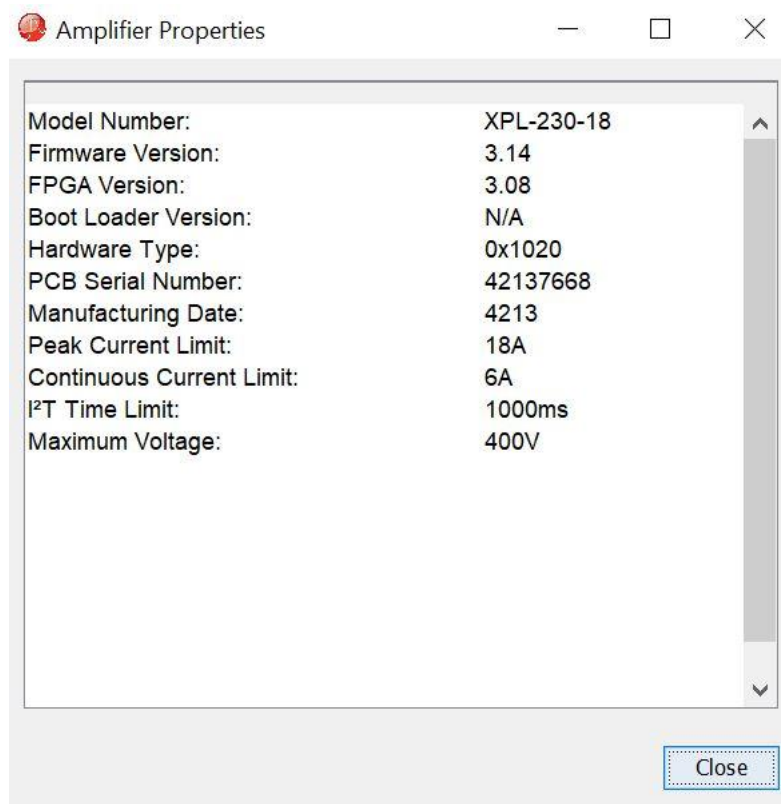



## 19.11 Communications Log

The communications log displays all communications between CME and the amplifier. The data is only stored in the PC's RAM by CME; it is not part of the amplifier's data.

On the Main screen, choose **Tools→Communications Log**

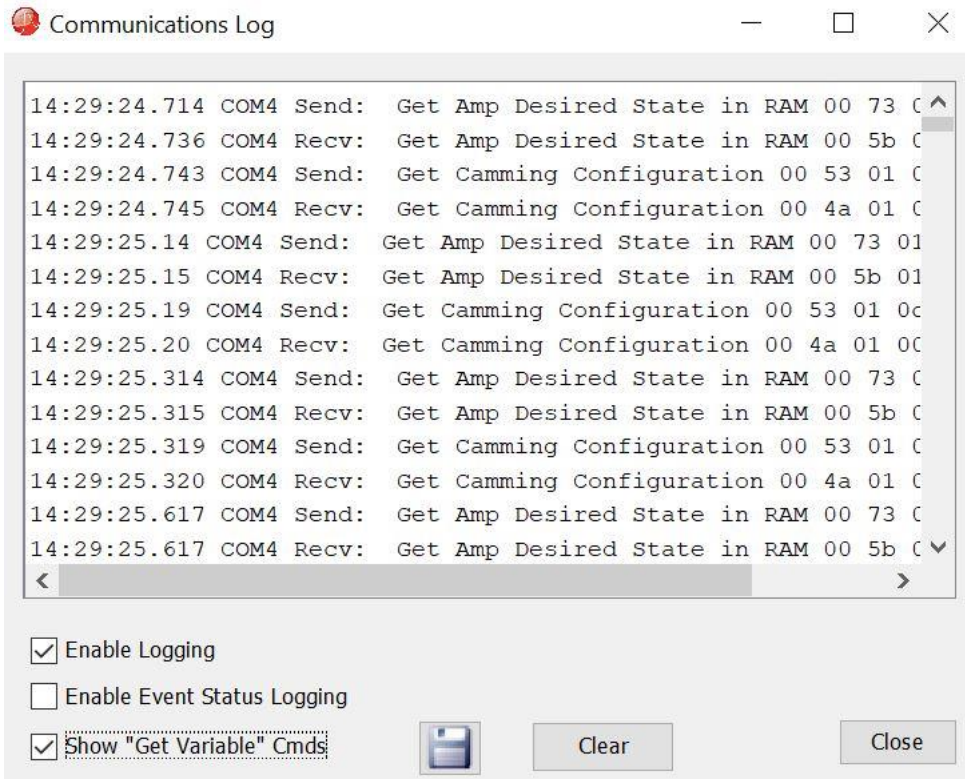
## Data, Firmware and Logs



Option	Description
Enable Logging	When selected, logging is enabled and all communications, with the exception of status messages, are recorded in the log
Enable Event Status Logging	When selected, status messages are included in the log. Note that <b>Show "Get Variable" Cmds</b> must also be checked to log Event Status commands.
Show "Get Variable" Cmds	When selected, "Get Variable" commands are added to the log.
	Saves the contents of the Communications Log to a text file.
	Clears the log contents from the PC's RAM

## 20 VIRTUAL AMPLIFIER

### 20.1 Overview

Virtual amplifiers can be used for creating amplifier and motor data files off line. A new virtual amplifier can be created based on a virtual amplifier template file (.ccv) or from an existing .ccx file. CME includes a set of .ccv files for each model that is supported.

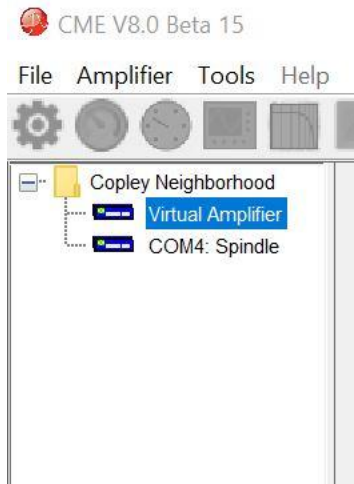

Select the **Virtual Amplifier** node from the Copley Neighborhood. This will display the Open Virtual Amplifier screen:

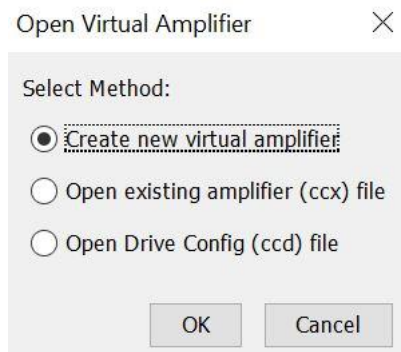

#### **Create new amplifier file**

- Select Create new amplifier and click OK.
- When prompted, select the .ccv that represents the appropriate drive model.
- Click Open. The Setup screen will be displayed.
- Motor and amplifier values may now be viewed, entered, and adjusted.

#### **Open existing amplifier file**

- Select Open existing amplifier file and click OK.
- When prompted, select the appropriate .ccx file.
- Click Open.
- Motor and amplifier values may now be viewed, entered, and adjusted.

## 21 GAIN SCHEDULING

### 21.1 Overview

The Gains Scheduling feature allows you to schedule gain adjustments based on changes to a key parameter. For instance,  $P_p$ ,  $V_p$ ,  $V_i$ , and Current Offset (A) could be adjusted based on changes to commanded velocity.

Gain adjustments are specified in a Gain Scheduling Table. Each table row contains a key parameter value and the corresponding gain settings. The amplifier uses linear interpolation to make smooth gain adjustments between the programmed settings.

Gain scheduling involves the basic steps outlined below.

### Storage Limits

The maximum number of lines that can be stored in the Gain Scheduling Table is 1000. A typical Gain Schedule Table will contain far fewer lines. The number of Gain Scheduling Table lines is also limited by the amount of CVM memory space available in the amplifier. A Gain Scheduling Table shares that space with CVM programs and Camming Tables. Therefore, the maximum number of Gain Schedule Table lines will decrease if CVM programs or Camming Tables are stored in the amplifier.

The **Table** tab of the Gain Scheduling screen displays the percentage of amplifier memory used:



### 21.2 Configure Gain Scheduling

- From the menu on Main screen, choose **Amplifier**→**Gain Scheduling**.

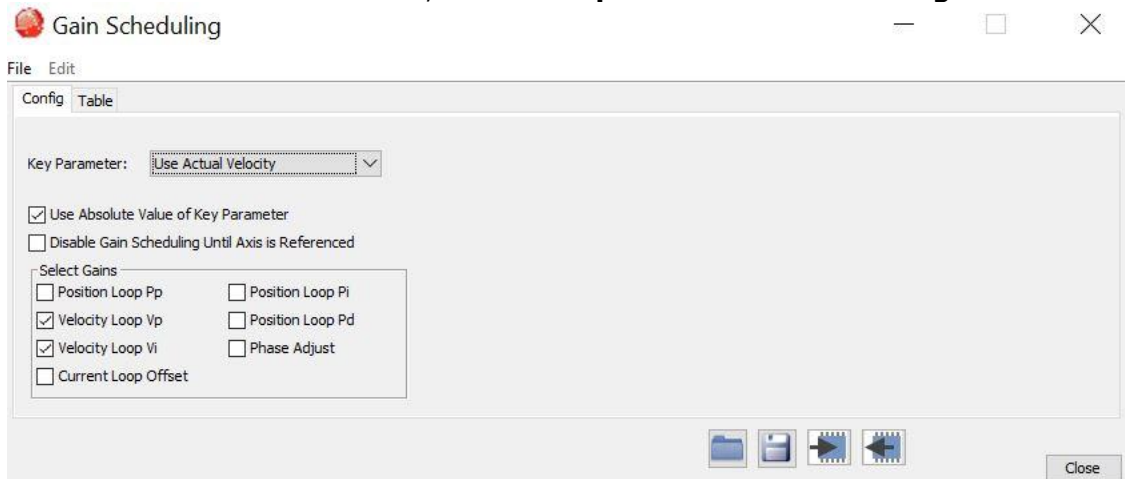

2. Choose the **Key Parameter**:

Key Parameter	Description
Disable Gain Scheduling.	Disable gain scheduling.
Use Written Parameter.	An external controller can write to this parameter using any of several protocols and corresponding parameter IDs: Copley ASCII Interface or the Copley Indexer 2 Program (ID 0x128), CANopen and EtherCAT (Index 0x2371), and MACRO I-variable (0x528). See the Copley ASCII Interface Programmer's Guide, the Copley Indexer 2 Program User Guide, or the Copley CANopen Programmer's Guide.
Use Commanded Velocity.	Schedule gain adjustments based on changes to commanded velocity.
Use Actual Velocity.	Schedule gain adjustments based on changes to actual velocity.
Use Commanded Position.	Schedule gain adjustments based on changes to commanded position.
Use Actual Position.	Schedule gain adjustments based on changes to actual position.

Optionally set controls:





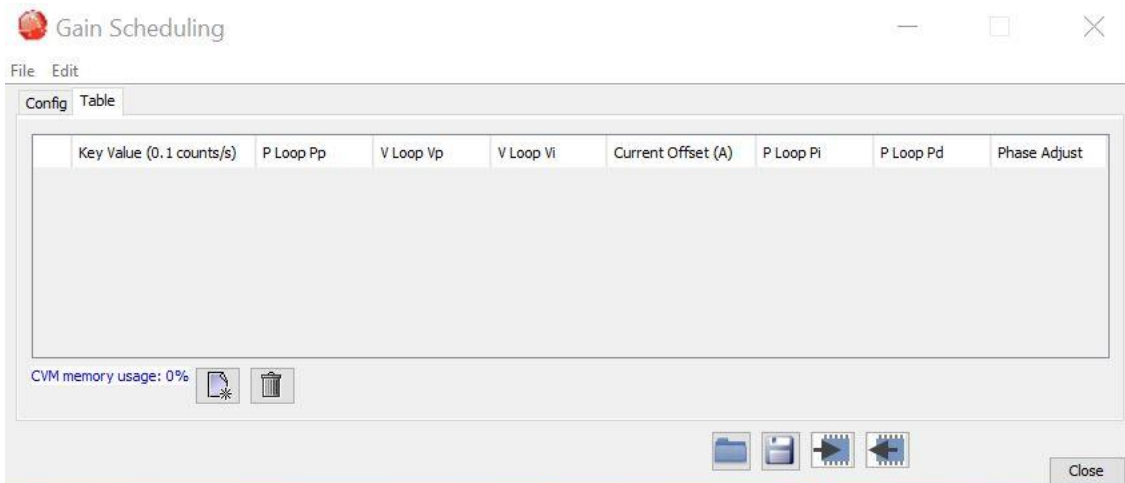

Control	Description
Use Absolute Value of Key Parameter	If a velocity or position value is chosen for the Key Parameter and this option is set, the Key Parameter is interpreted as an absolute value.
Disable Gain Scheduling Until Axis is Referenced	When this option is set, the scheduled gain adjustments do not take place until the axis is referenced (homed).

3. Select the gains that you wish to adjust by schedule. The choices are Pp, Vp, Vi and Current Offset (A). For each gain you select, a column will be enabled in the Gain Scheduling Table.
4. Continue with [Set Up Gain Scheduling Tables](#).

## 21.3 Set Up Gain Scheduling Tables

On the Gain Scheduling screen, open the Table tab:



Action	Description
	Creates a new table
	Deletes the table from amplifier flash and PC RAM
	Saves configuration and table to disk
	Restores configuration and table to PC only
	Saves configuration and table to amplifier flash
	Restores configuration and table from amplifier flash to PC. This operation overwrites all data on the Gains Scheduling screen.

1. On the Gain Scheduling screen, open the Table tab:

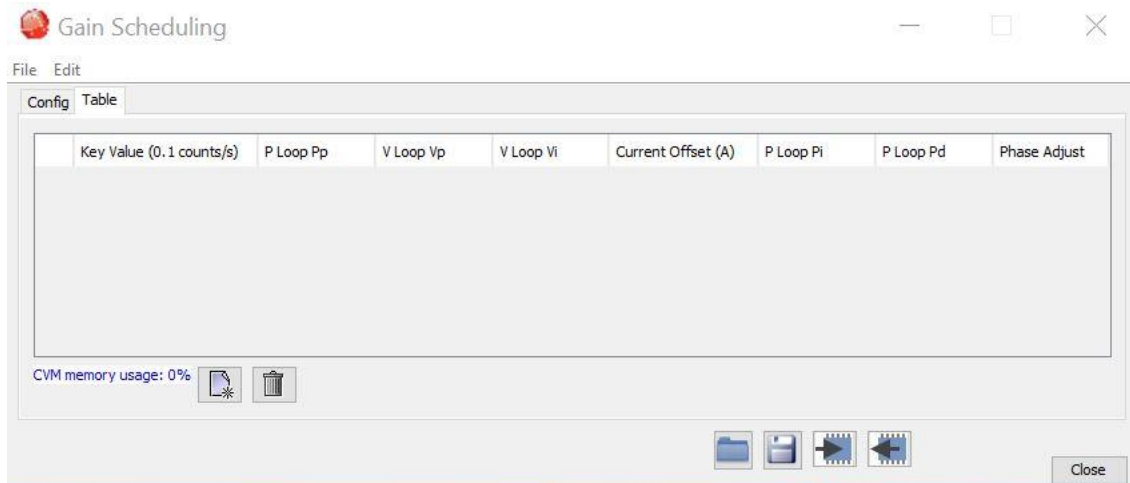

2. Click the Create New Table button  and enter the number of lines for the table.



3. Enter the Key Parameter and gain adjustment values.

**NOTE:**

- All values must be whole numbers (no fractional values).
  - All Key Values must be increasing.
4. After all values have been entered, click the Save Table button . This action saves both configuration and table data.

Gain Scheduling

File Edit

Config Table

	Key Value (0.1 counts/s)	P Loop Pp	V Loop Vp	V Loop Vi	Current Offset (A)	P Loop Pi	P Loop Pd	Phase Adjust
0	0		0	0				
1	81920		1100	11				
2	8192000		1500	150				

CVM memory usage: 1%

Close

## 22 REGEN RESISTOR CONFIGURATION



### WARNING

**Incorrect values may damage amplifier or external regen resistor.**

For the regen I<sup>2</sup>T algorithms to work correctly, the values entered in the following steps must be correct. Damage to the external regen resistor may result from incorrect values entered. Damage to the amplifier may result if an incorrect resistance value is entered.

**Failure to heed this warning can cause equipment damage.**

### 22.1 Configure a Standard Copley Controls Regen Resistor

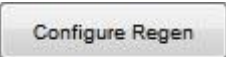
1. Click Configure **Regen**  to open the Regen Resistor screen.

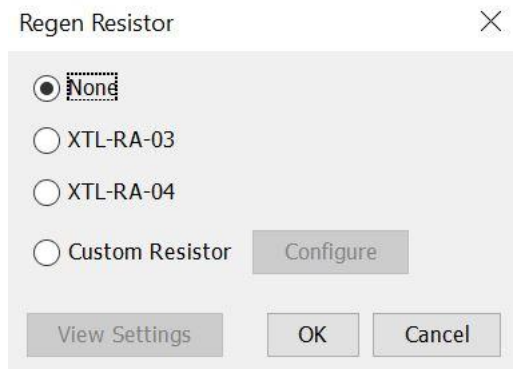

2. Select the model number XTL-RA-03 or XTL-RA-04 based on your drive and click **OK** to save the configuration and close the screen.

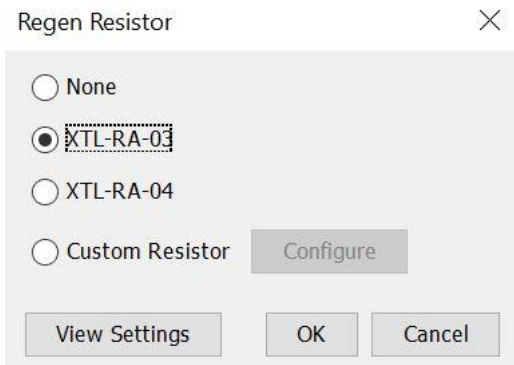

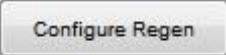

## 22.2 Configure a Custom Regen Resistor

1. Click **Configure Regen**  to open the Regen Resistor screen.

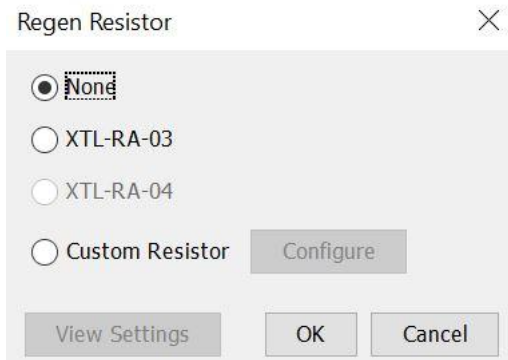

2. Select Custom Resistor and click **Configure** to enter the custom resistor data. Read the information displayed and click **OK**.

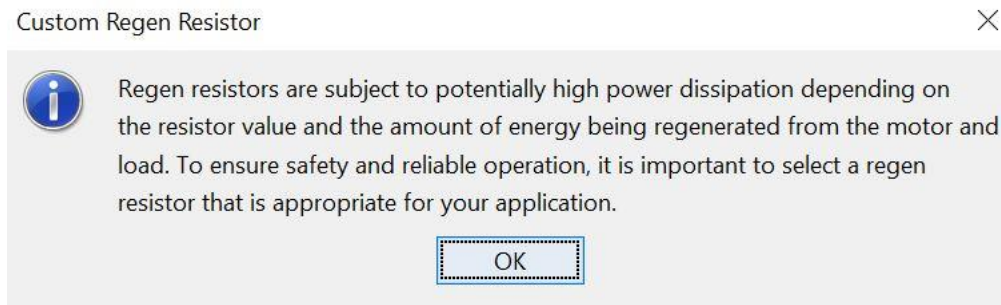

3. Follow the instructions on step 1 through 5 of the Custom Regen Wizard, then click **Finish**.

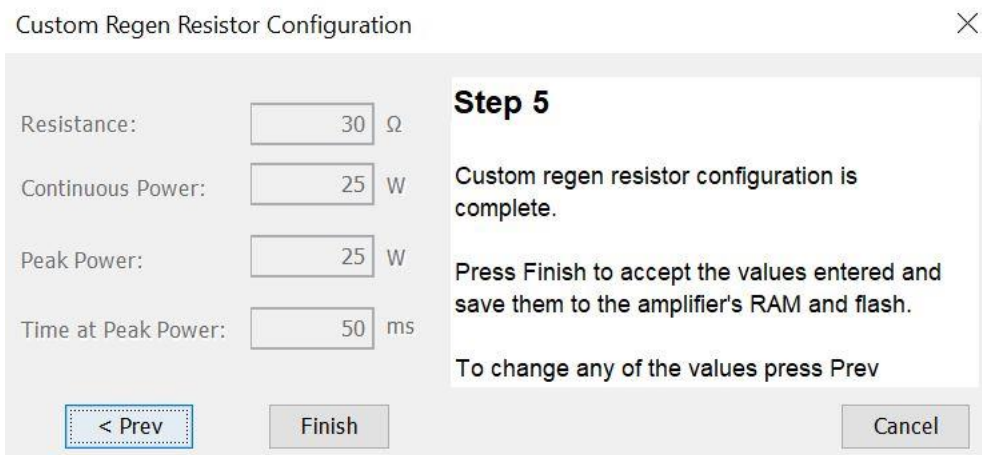

## Regen Resistor Configuration

### View Regen Settings

1. Click **Configure Regen**  to open the Regen Resistor screen.

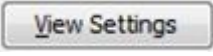
Click **View Settings**  to open the Regen Settings screen.

Regen Settings ×

Resistance:	<input type="text" value="30"/>	$\Omega$
Continuous Power:	<input type="text" value="25"/>	W
Peak Power:	<input type="text" value="25"/>	W
Time at Peak Power:	<input type="text" value="50"/>	ms

## APPENDIX A

### I<sup>2</sup>T TIME LIMIT ALGORITHM

#### Overview

The I<sup>2</sup>T current limit algorithm continuously monitors the energy being delivered to the motor using the I<sup>2</sup>T Accumulator Variable. The value stored in the I<sup>2</sup>T Accumulator Variable is compared with the I<sup>2</sup>T setpoint that is calculated from the user-entered Peak Current Limit, I<sup>2</sup>T Time Limit, and Continuous Current Limit. Whenever the energy delivered to the motor exceeds the I<sup>2</sup>T setpoint, the algorithm protects the motor by limiting the output current or generates a fault.

#### Formulas and Algorithm Operation

##### Calculating the I<sup>2</sup>T Setpoint Value

The I<sup>2</sup>T setpoint value has units of Amperes<sup>2</sup>-seconds (A<sup>2</sup>S) and is calculated from programmed motor data. The setpoint is calculated from the Peak Current Limit, the I<sup>2</sup>T Time Limit, and the Continuous Current Limit as follows:

$$\text{I}^2\text{T setpoint} = (\text{Peak Current Limit}^2 - \text{Continuous Current Limit}^2) * \text{I}^2\text{T Time Limit}$$

##### Algorithm Operation

During amplifier operation, the I<sup>2</sup>T algorithm periodically updates the I<sup>2</sup>T Accumulator Variable at a rate related to the output current Sampling Frequency. The value of the I<sup>2</sup>T Accumulator Variable is incrementally increased for output currents greater than the Continuous Current Limit and is incrementally decreased for output currents less than the Continuous Current Limit. The I<sup>2</sup>T Accumulator Variable is not allowed to have a value less than zero and is initialized to zero upon reset or +24 Vdc logic supply power-cycle.

##### Accumulator Increment Formula

At each update, a new value for the I<sup>2</sup>T Accumulator Variable is calculated as follows:

$$\begin{aligned} \text{I}^2\text{T Accumulator Variable}_{n+1} = & \\ & \text{I}^2\text{T Accumulator Variable}_n \\ & + (\text{Actual Output Current}_{n+1}^2 - \text{Continuous Current Limit}^2) * \text{Update period} \end{aligned}$$

After each sample, the updated value of the I<sup>2</sup>T Accumulator Variable is compared with the I<sup>2</sup>T setpoint. If the I<sup>2</sup>T Accumulator Variable value is greater than the I<sup>2</sup>T Setpoint value, then the amplifier limits the output current to the Continuous Current Limit. When current limiting is active, the output current will be equal to the Continuous Current Limit if the commanded current is greater than the Continuous Current Limit. If instead the commanded current is less than or equal to the Continuous Current Limit, the output current will be equal to the commanded current.

### Application Example

Operation of the I<sup>2</sup>T current limit algorithm is best understood through an example. For this example, a motor with the following characteristics is used:

- Peak Current Limit – 12 A
- I<sup>2</sup>T Time Limit – 1 S
- Continuous Current Limit – 6 A

From this information, the I<sup>2</sup>T setpoint is:

$$\text{setpoint} = (12 \text{ A}^2 - 6 \text{ A}^2) * 1 \text{ S} = 108 \text{ A}^2\text{S}$$

### Plot Diagrams

The plots that follow show the response of an amplifier (configured w/ I<sup>2</sup>T setpoint = 108 A<sup>2</sup>S) to a given current command. For this example, DC output currents are shown in order to simplify the waveforms. The algorithm essentially calculates the RMS value of the output current, and thus operates the same way regardless of the output current frequency and wave shape.

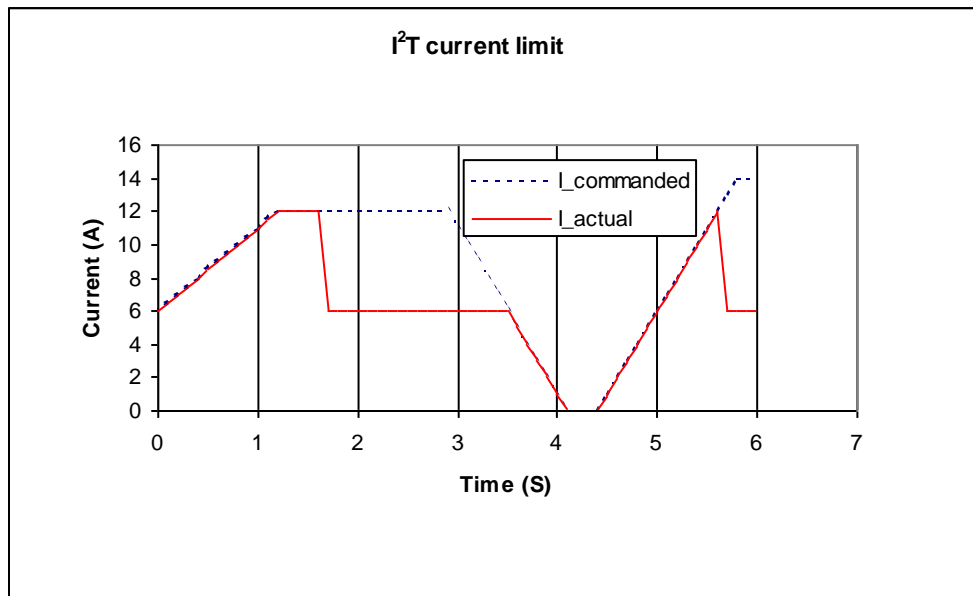

Diagram A

At time 0, plot diagram A shows that the actual output current follows the commanded current. Note that the current is higher than the continuous current limit setting of 6 A. Under this condition, the I<sup>2</sup>T Accumulator Variable begins increasing from its initial value of zero. Initially, the output current linearly increases from 6 A up to 12 A over the course of 1.2 seconds. During this same period, the I<sup>2</sup>T Accumulator Variable increases in a non-linear fashion because of its dependence on the square of the current.

At about 1.6 seconds, the I<sup>2</sup>T Accumulator Variable reaches a value equal to the I<sup>2</sup>T setpoint. At this time, the amplifier limits the output current to the continuous current limit even though the commanded current remains at 12 A. The I<sup>2</sup>T Accumulator Variable value remains constant during the next 2 seconds since the difference between the actual output current and the continuous current limit is zero.

## Appendix A

At approximately 3.5 seconds, the commanded current falls below the continuous current limit and once again the output current follows the commanded current. Because the actual current is less than the continuous current, the I<sup>2</sup>T Accumulator Variable value begins to fall incrementally.

The I<sup>2</sup>T Accumulator Variable value continues to fall until at approximately 5.0 seconds when the commanded current goes above the continuous current limit again. The actual output current follows the current command until the I<sup>2</sup>T Accumulator Variable value reaches the I<sup>2</sup>T setpoint and current limiting is invoked.

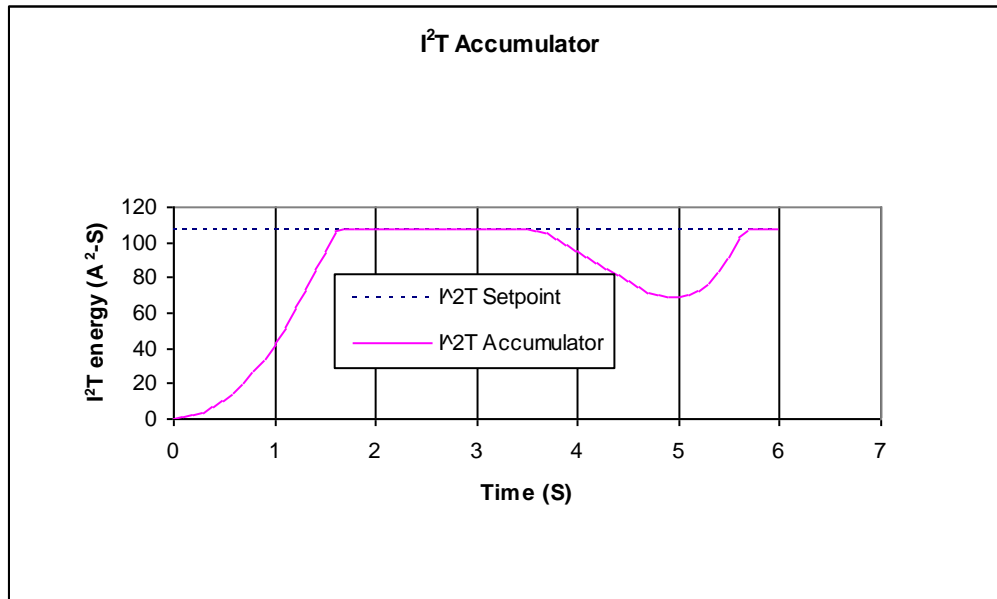

Diagram B

### I<sup>2</sup>T Scope Trace Variables

Two Scope Tool trace variables are available for monitoring whether the I<sup>2</sup>T accumulator is accumulating or discharging.

- The I<sup>2</sup>T Amplifier Accumulator variable evaluates the accumulator against the factory set current limits of the amplifier.
- The I<sup>2</sup>T Motor Accumulator variable evaluates the accumulator against the user-programmed current loop values.

The value shown Diagram B has been normalized so that 100% equals the I<sup>2</sup>T setpoint.

When either trace variable line reaches 100%, current limiting will be invoked.

## APPENDIX B

### HOMING METHODS

#### Overview

There are several homing methods. Each method establishes the:

- Home reference (limit or home switch transition or encoder index pulse)
- Direction of motion and, where appropriate, the relationship of the index pulse to limit or home switches.

#### Homing Diagram Legend

As highlighted in the example below, each homing method diagram shows the starting position on a mechanical stage. The arrow line indicates direction of motion, and the circled H indicates the home position. Solid line stems on the index pulse line indicate index pulse locations. Longer dashed lines overlay these stems as a visual aid. Finally, the relevant limit switch is represented, showing the active and inactive zones and transition.

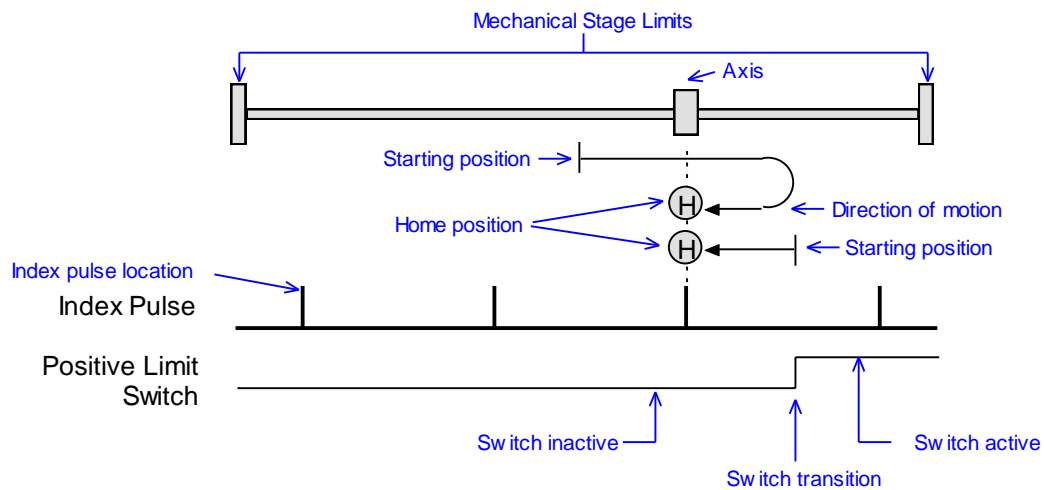

Note that in the homing method descriptions, negative motion is leftward and positive motion is rightward.

#### Homing Method Descriptions

##### Set current position as home

The current position is the home position.

##### Next Index

##### Direction of Motion: Positive

Home is the first index pulse found in the positive direction. Direction of motion is positive. If a positive limit switch is activated before the index pulse, an error is generated.

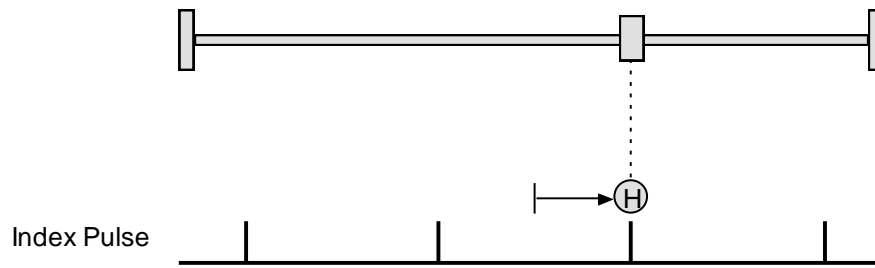

**Direction of Motion: Negative**

Home is the first index pulse found in negative direction. Direction of motion is negative. If a negative limit switch is activated before the index pulse, an error is generated.

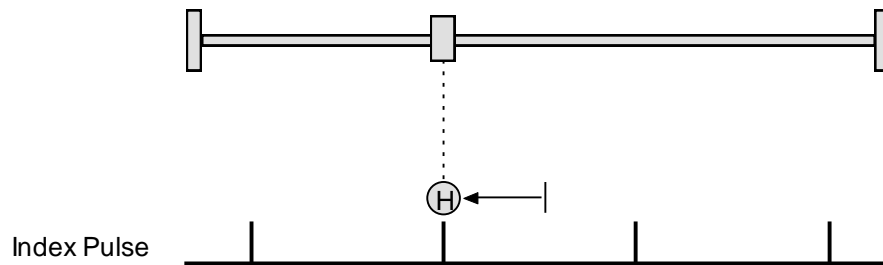

**Limit Switch**

**Direction of Motion: Positive**

Home is the transition of the positive limit switch. Initial direction of motion is positive if the positive limit switch is inactive.

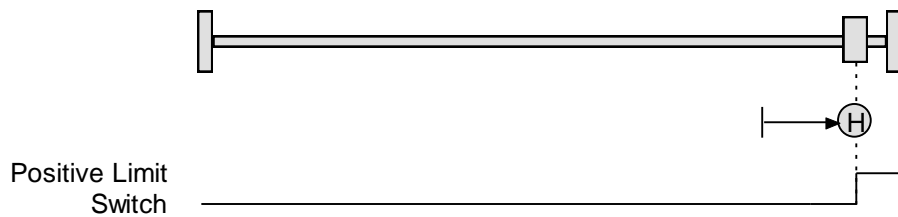

**Direction of Motion: Negative**

Home is the transition of negative limit switch. Initial direction of motion is negative if the negative limit switch is inactive.

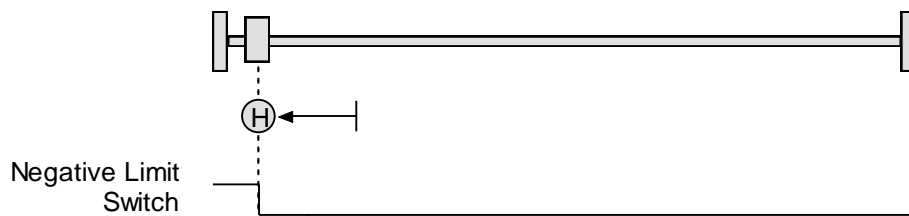

**Limit Switch Out to Index**

**Direction of Motion: Positive**

Home is the first index pulse to the negative side of the positive limit switch transition. Initial direction of motion is positive if the positive limit switch is inactive (shown here as low).

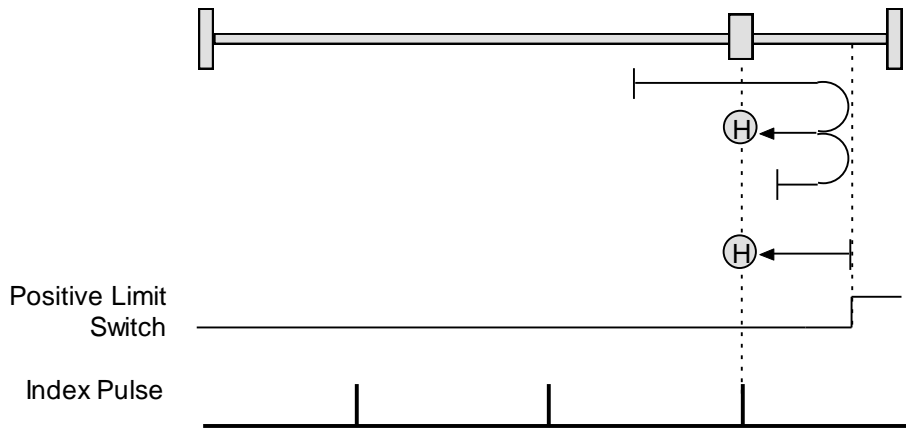

**Direction of Motion: Negative**

Home is the first index pulse to the positive side of the negative limit switch transition. Initial direction of motion is negative if the negative limit switch is inactive (shown here as low).

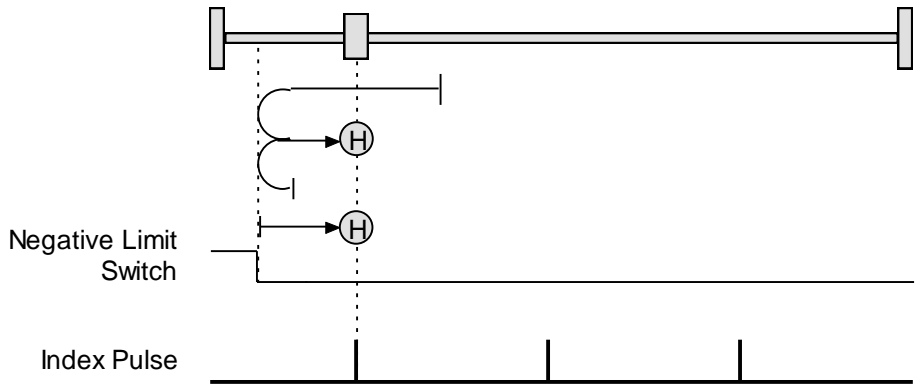

**Hardstop**

**Direction of Motion: Positive**

Home is the positive hard stop. Direction of motion is positive. In servo modes, the hard stop is reached when the amplifier outputs the homing Current Limit continuously for the amount of time specified in the Delay Time.

If a positive limit switch is activated before the hard stop, an error is generated.



**Direction of Motion: Negative**

Home is the negative hard stop. Direction of motion is negative. The hard stop is reached when the amplifier outputs the homing Current Limit continuously for the amount of time specified in the Delay Time. If a negative limit switch is activated before the hard stop, an error is generated.



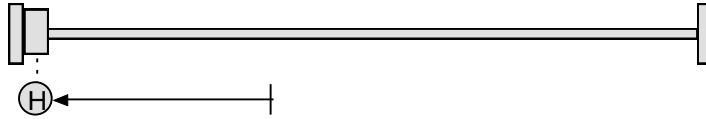

**Hardstop Methods in Stepper Mode**

In Stepnet amplifiers operating in stepper mode with an encoder, the hard stop is reached when the following error is exceeded. When using hardstop methods in stepper mode, do not disable following error.

**Hardstop Out to Index**

**Direction of Motion: Positive**

Home is the first index pulse on the negative side of the positive hard stop. Initial direction of motion is positive. The hard stop is reached when the amplifier outputs the homing Current Limit continuously for the amount of time specified in the Delay Time. If a positive limit switch is activated before the hard stop, an error is generated.

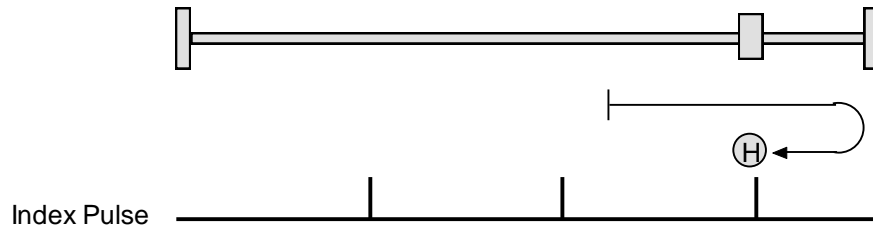

**Direction of Motion: Negative**

Home is the first index pulse on the positive side of the negative hard stop. Initial direction of motion is negative. The hard stop is reached when the amplifier outputs the homing Current Limit continuously for the amount of time specified in the Delay Time. If a negative limit switch is activated before the hard stop, an error is generated.

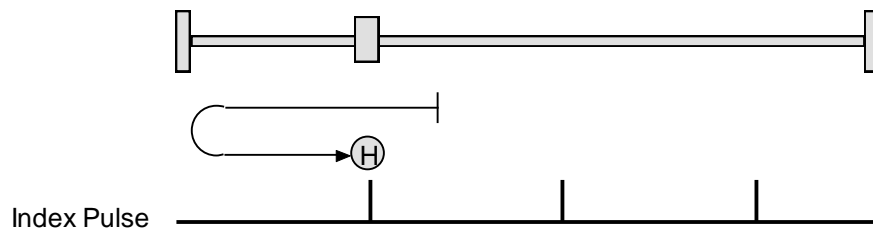

**Hardstop Out to Index Methods in Stepper Mode**

In Stepnet amplifiers operating in stepper mode with an encoder, the hard stop is reached when the following error is exceeded. When using hardstop methods in stepper mode, do not disable following error.

**Home Switch**

**Direction of Motion: Positive**

Home is the home switch transition. Initial direction of motion is positive if the home switch is inactive. If a limit switch is activated before the home switch transition, an error is generated.

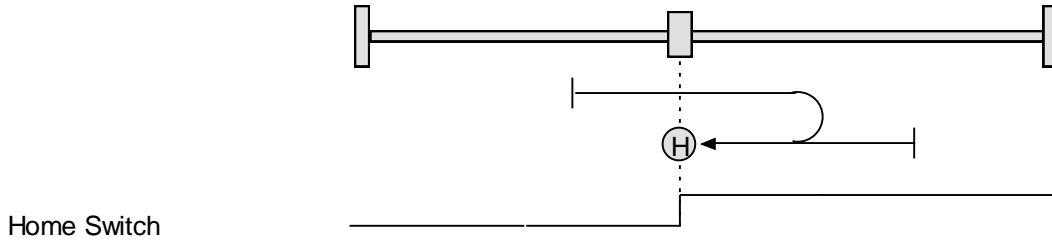

**Direction of Motion: Negative**

Home is the home switch transition. Initial direction of motion is negative if the home switch is inactive. If a limit switch is activated before the home switch transition, an error is generated.

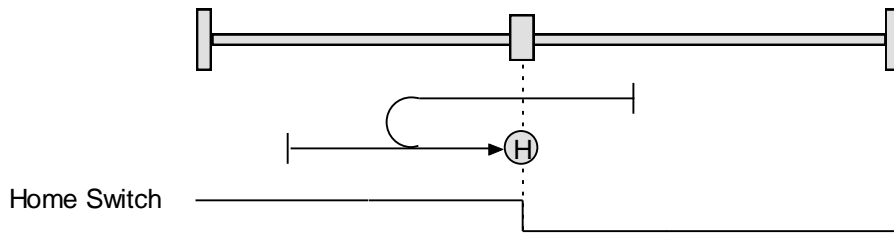

**Home Switch Out to Index**

**Direction of Motion: Positive**

Home is the first index pulse to the negative side of the home switch transition. Initial direction of motion is positive if the home switch is inactive. If a limit switch is activated before the home switch transition, an error is generated.

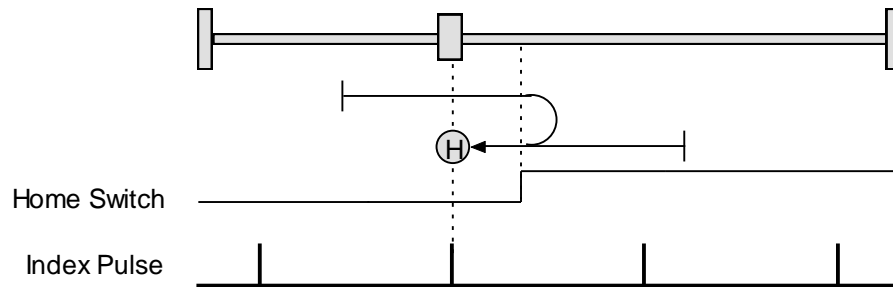

**Direction of Motion: Negative**

Home is the first index pulse to the positive side of the home switch transition. Initial direction of motion is negative if the home switch is inactive. If a limit switch is activated before the home switch transition, an error is generated.

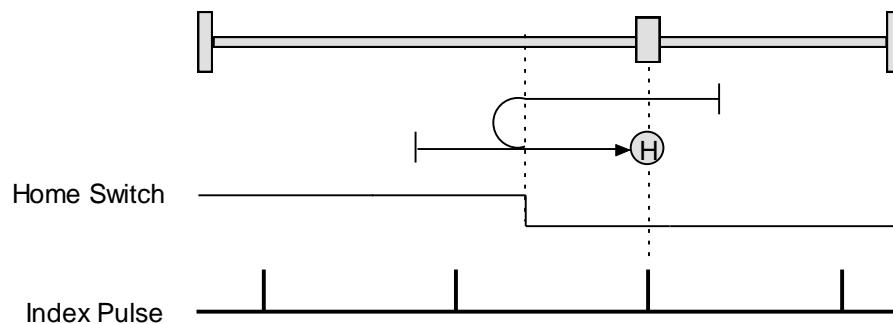

**Home Switch In to Index**

**Direction of Motion: Positive**

Home is the first index pulse to the positive side of the home switch transition. Initial direction of motion is positive if the home switch is inactive. If a limit switch is activated before the home switch transition, an error is generated.

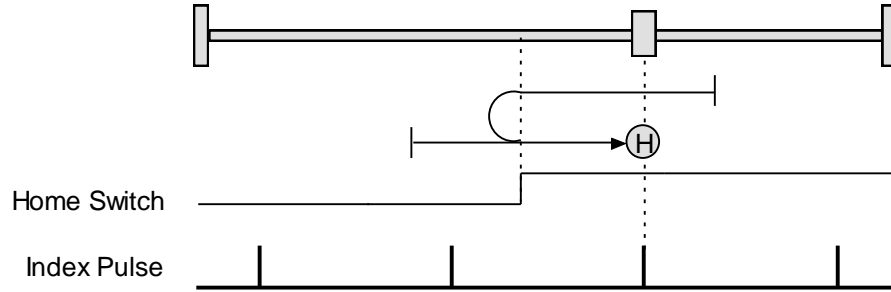

**Direction of Motion: Negative**

Home is the first index pulse to the negative side of the home switch transition. Initial direction of motion is negative if the home switch is inactive. If a limit switch is activated before the home switch transition, an error is generated.

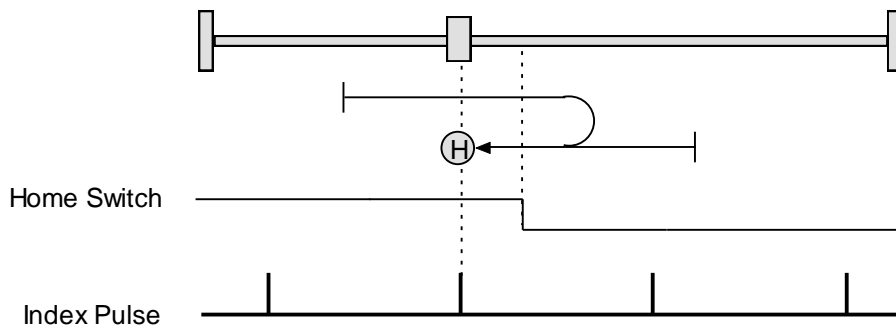

**Lower Home**

**Direction of Motion: Positive**

Home is the negative edge of a momentary home switch. Initial direction of motion is positive if the home switch is inactive. Motion will reverse if a positive limit switch is activated before the home switch; then, if a negative limit switch is activated before the home switch, an error is generated.

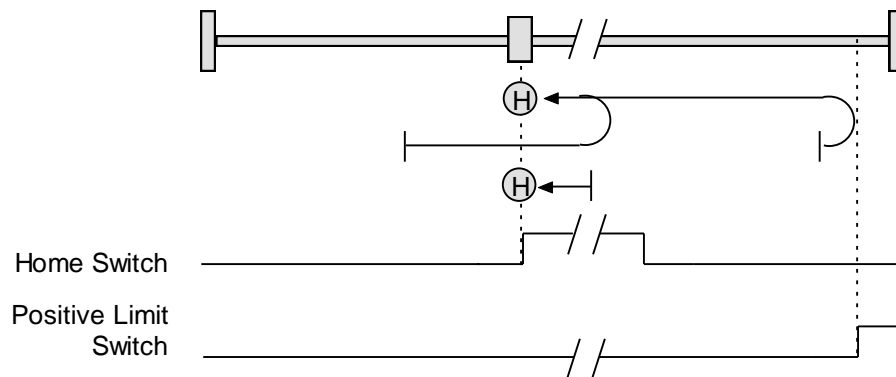

**Direction of Motion: Negative**

Home is the negative edge of a momentary home switch. Initial direction of motion is negative. If the initial motion leads away from the home switch, the axis reverses on encountering the negative limit switch; then, if a positive limit switch is activated before the home switch, an error is generated.

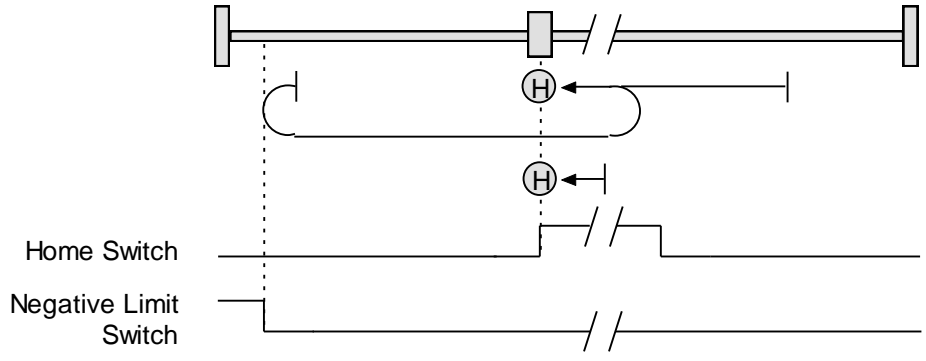

**Upper Home**

**Direction of Motion: Positive**

Home is the positive edge of a momentary home switch. Initial direction of motion is positive. If the initial motion leads away from the home switch, the axis reverses on encountering the positive limit switch; then, if a negative limit switch is activated before the home switch, an error is generated.

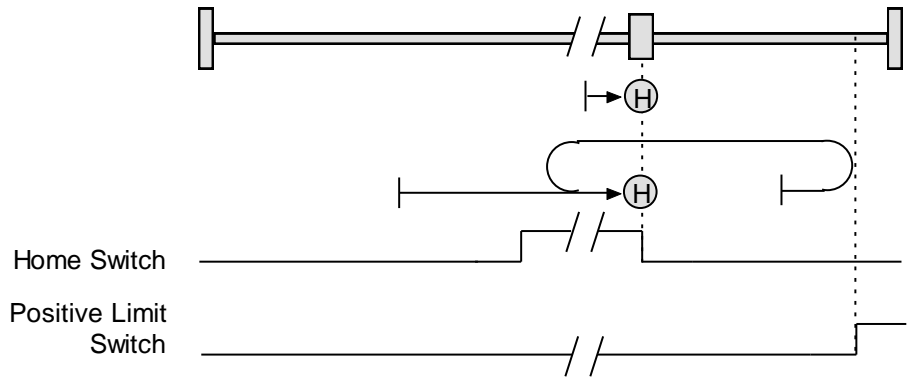

**Direction of Motion: Negative**

Home is the positive edge of momentary home switch. Initial direction of motion is negative if the home switch is inactive. If the initial motion leads away from the home switch, the axis reverses on encountering the negative limit switch; then, if a positive limit switch is activated before the home switch, an error is generated.

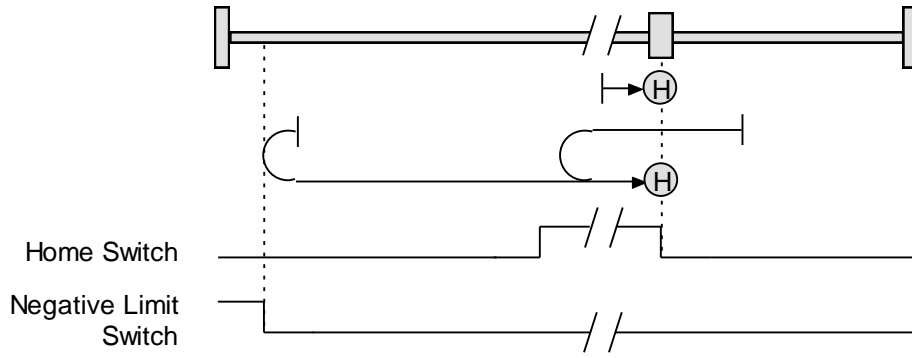

**Lower Home Outside Index**

**Direction of Motion: Positive**

Home is the first index pulse on the negative side of the negative edge of a momentary home switch. Initial direction of motion is positive if the home switch is inactive. If the initial motion leads away from the home switch, the axis reverses on encountering the positive limit switch; then, if a negative limit switch is activated before the home switch, an error is generated.

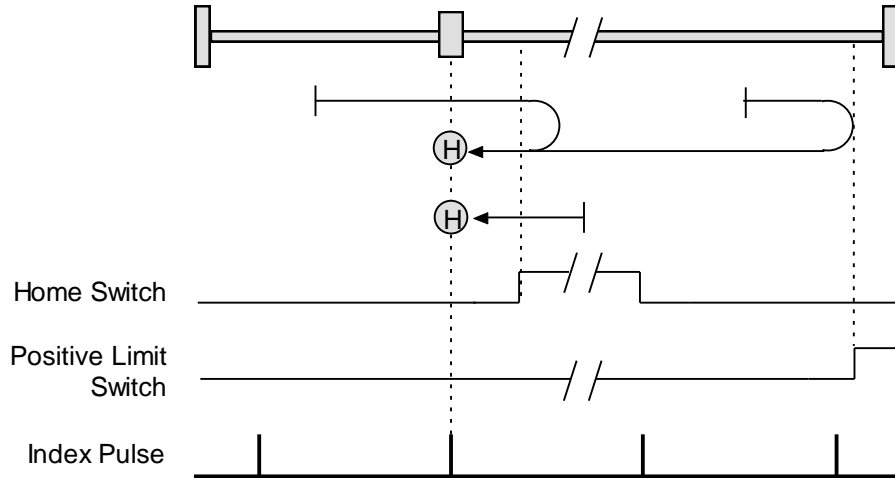

**Direction of Motion: Negative**

Home is the first index pulse on the negative side of the negative edge of a momentary home switch. Initial direction of motion is negative. If the initial motion leads away from the home switch, the axis reverses on encountering the negative limit switch; then, if a negative limit switch is activated before the home switch, an error is generated.

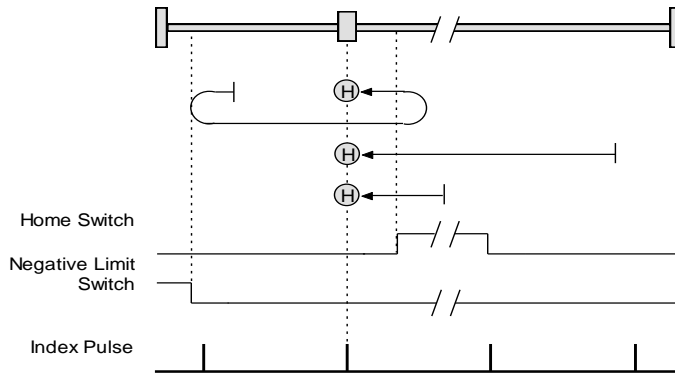

**Lower Home Inside Index**

**Direction of Motion: Positive**

Home is the first index pulse on the positive side of the negative edge of a momentary home switch. Initial direction of motion is positive if the home switch is inactive. If the initial motion leads away from the home switch, the axis reverses on encountering the positive limit switch; then, if a negative limit switch is activated before the home switch, an error is generated.

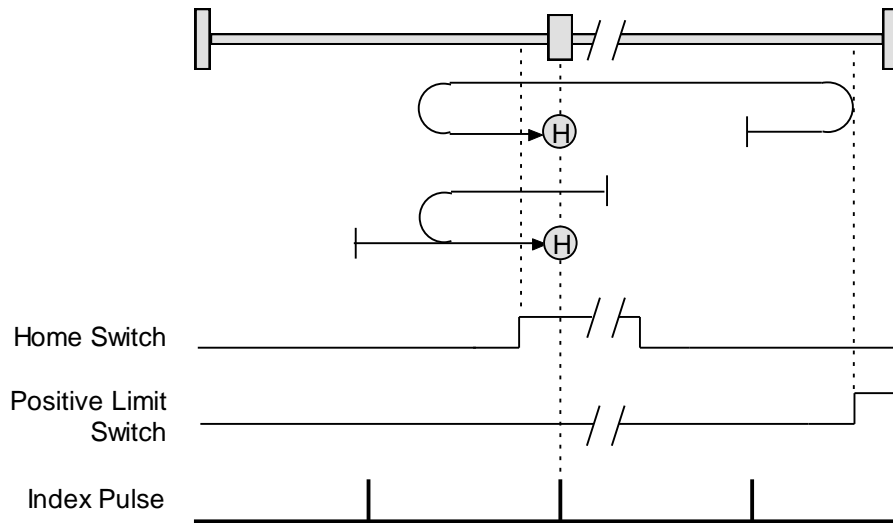

**Direction of Motion: Negative**

Home is the first index pulse on the positive side of the negative edge of a momentary home switch. Initial direction of motion is negative. If the initial motion leads away from the home switch, the axis reverses on encountering the negative limit switch; then, if a negative limit switch is activated before the home switch, an error is generated.

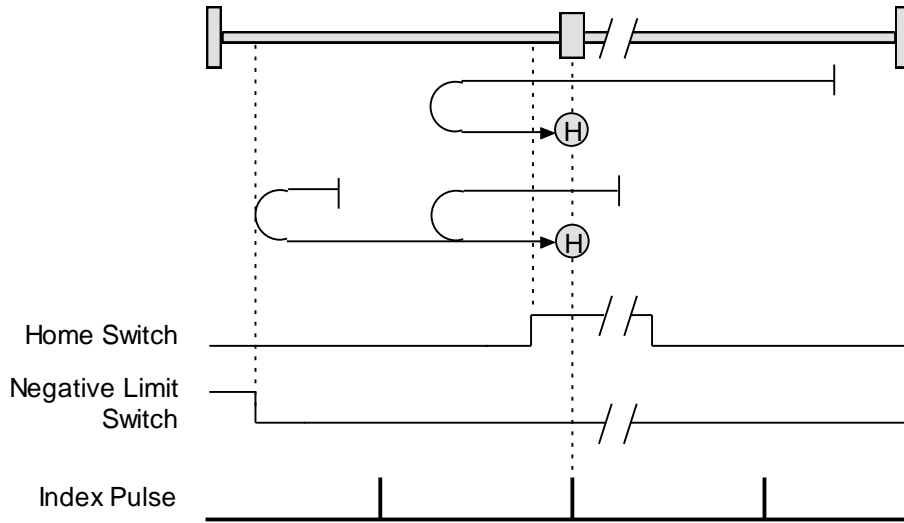

**Upper Home Outside Index**

**Direction of Motion: Positive**

Home is the first index pulse on the positive side of the positive edge of a momentary home switch. Initial direction of motion is positive. If the initial motion leads away from the home switch, the axis reverses on encountering the positive limit switch; then, if a negative limit switch is activated before the home switch, an error is generated.

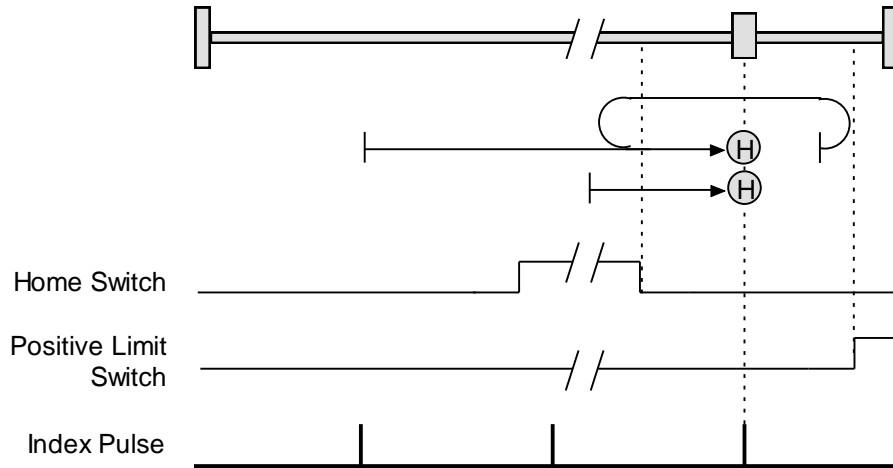

**Direction of Motion: Negative**

Home is the first index pulse on the positive side of the positive edge of a momentary home switch. Initial direction of motion is negative if the home switch is inactive. If the initial position is right of the home position, the axis reverses on encountering the home switch.

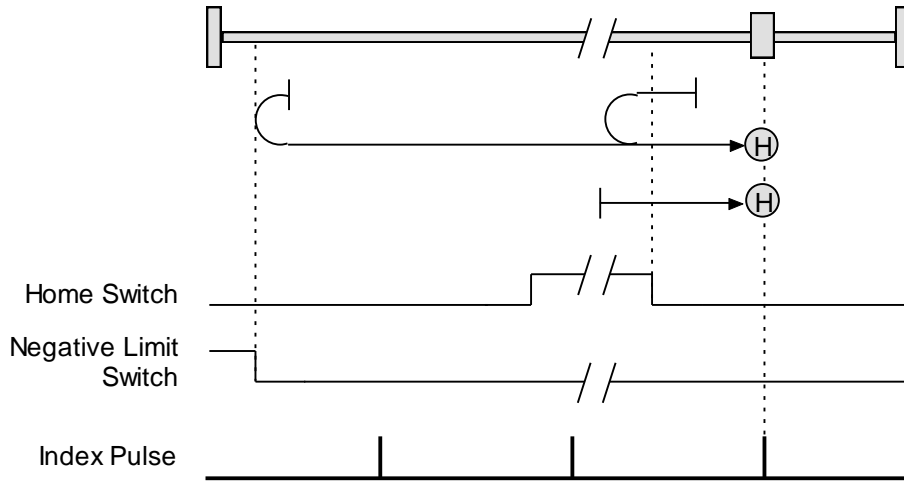

**Upper Home Inside Index**

**Direction of Motion: Positive**

Home is the first index pulse on the negative side of the positive edge of momentary home switch. Initial direction of motion is positive. If initial motion leads away from the home switch, the axis reverses on encountering the positive limit switch; then, if a negative limit switch is activated before the home switch, an error is generated.

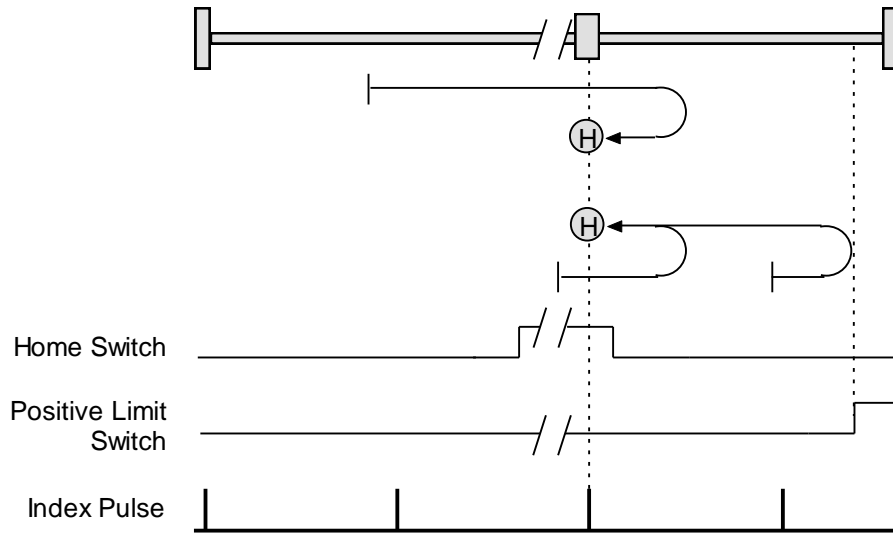

**Direction of Motion: Negative**

Home is the first index pulse on the negative side of the positive edge of a momentary home switch. Initial direction of motion is negative if the home switch is inactive. If initial motion leads away from the home switch, the axis reverses on encountering the negative limit; then, if a negative limit switch is activated before the home switch, an error is generated.



Appendix B

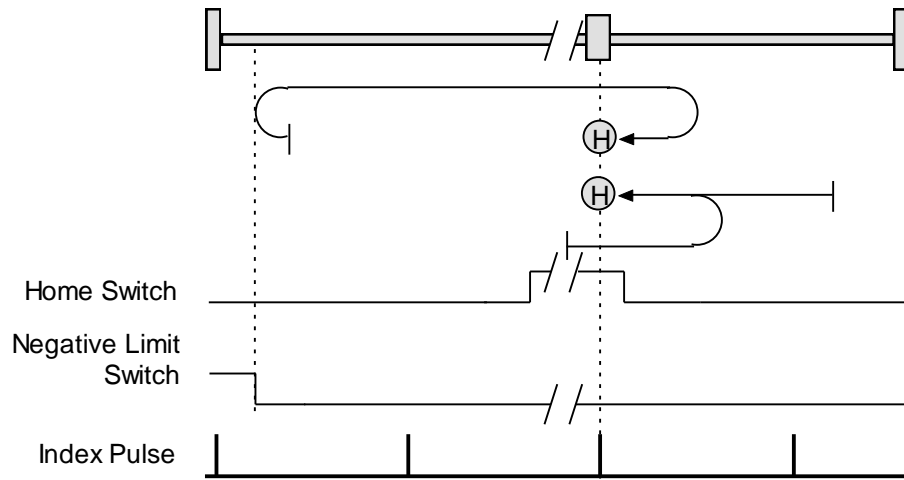

## APPENDIX C

### ASCII COMMANDS/SERIAL CONTROL

#### Copley ASCII Interface

An amplifier's RS-232 serial bus can be used by an external control application (HMI, PLC, PC, etc.) for setup and direct serial control of the amplifier. The control application can issue amplifier commands from the set of ASCII format commands that make up the Copley Controls ASCII Interface.

For more information, see the Copley ASCII Interface Programmer's Guide.

#### CME ASCII Command Line Interface Tool

As described below, the CME ASCII Command Line Interface tool provides a simple way to enter Copley ASCII commands.

Use the ASCII Command Line Interface to Enter Commands

1. From the Main screen, choose **Tools→ASCII Command Line** to open the tool.

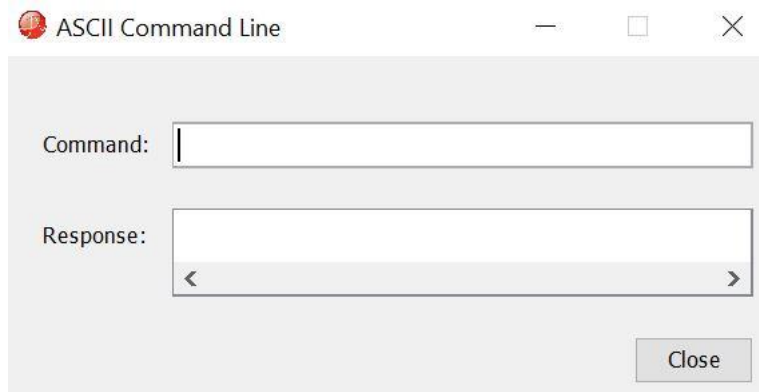

2. Enter an ASCII Command in the Command field.
3. Press the **Enter** key to send the command to the amplifier. Observe the Response field. If a value is returned, it is preceded by the letter "v." In the following example, the get command was used to retrieve the amplifier RAM value of variable 0x32 (actual position).

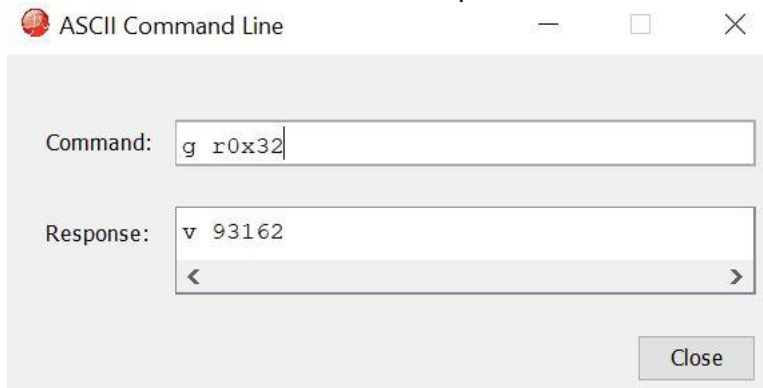

An error code would be preceded by the letter "e."

TIP: To view an error definition, hold the mouse pointer over the error number.

For more information, see the Copley ASCII Interface Programmer's Guide and the Copley Amplifier Parameter Dictionary.

## Single-Axis Serial Connection

For RS-232 serial bus control of a single axis, set the CAN node address of that axis to zero (0). Note that if the CAN node address is switched to zero after power-up, the amplifier must be reset or power cycled to make the new address setting take effect.

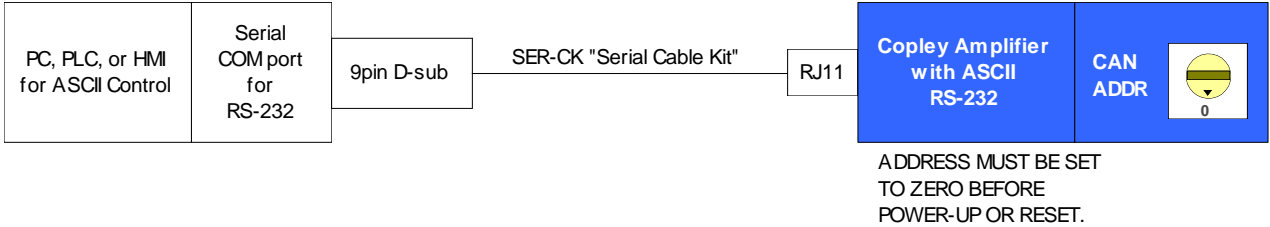

## Multi-Drop Serial Connection

A serially connected amplifier can be used as a multi-drop gateway for access to other amplifiers linked in a series of CAN bus connections. Set the CAN node address of the serially connected amplifier (gateway) to zero (0). Assign each additional amplifier in the chain a unique CAN node address value between 1 and 127. For more information on CAN node address assignment, see [Network Configuration](#). Use 120 Ohms termination on the first and last amplifier.

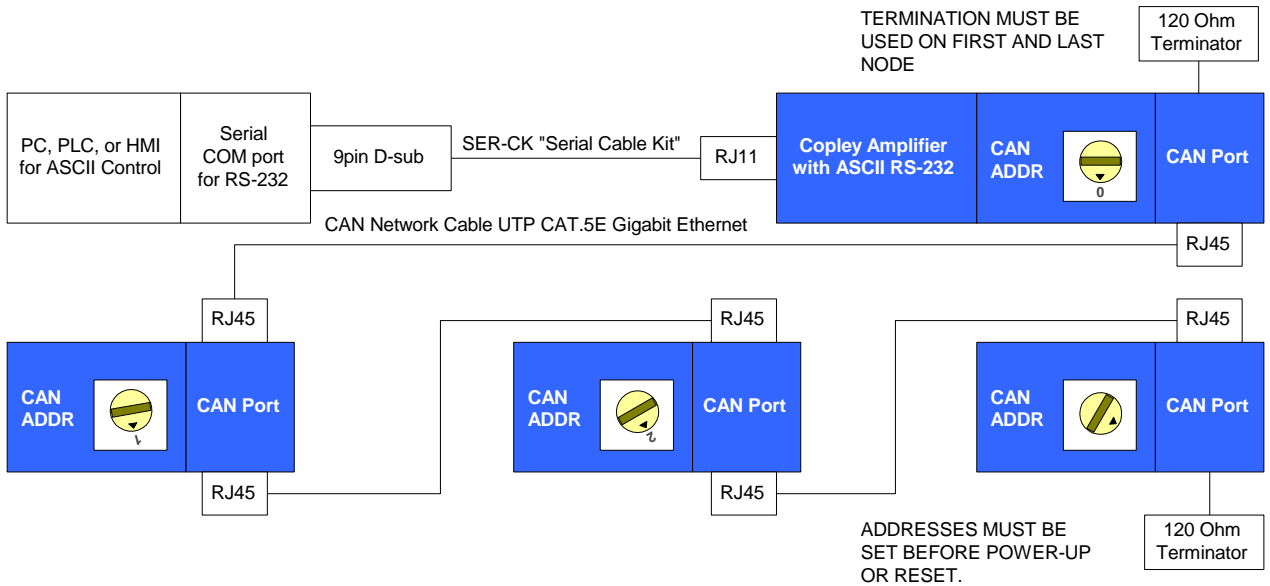

## APPENDIX D

### COPLEY USB TO RJ11

#### Recommended Device

Copley Controls recommends using **Copley SER-USB-RJ11**.

#### Factory Settings

The factory settings for this device works well. To confirm that drivers are installed, and default settings are correct, use Windows Device Manager.

- 1 Open the Device Manager dialog from the Windows Control Panel and expand the **Ports (COM & LPT)** node:

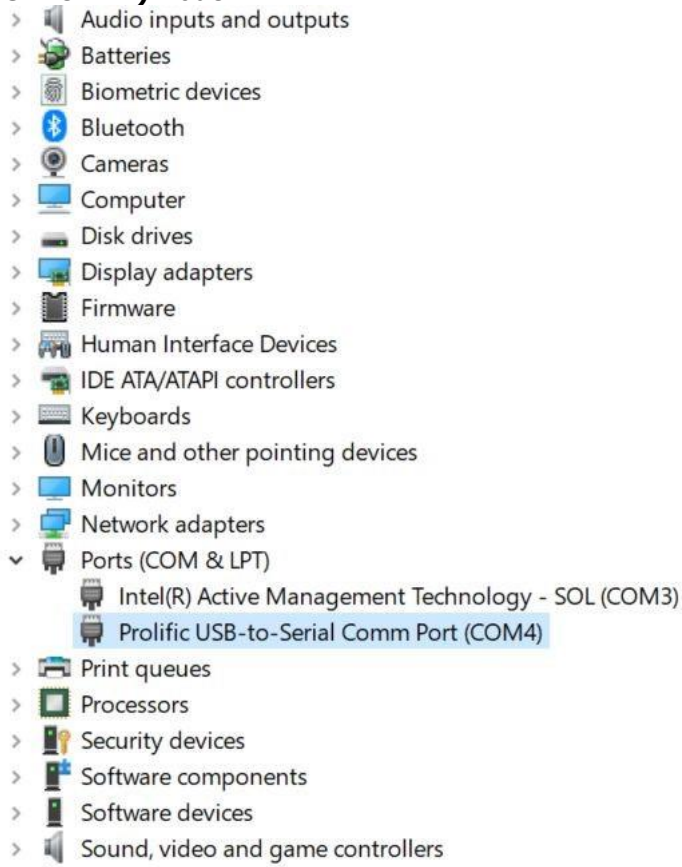

- 2 Select the COM port that is used by the USB to Serial Adapter. Confirm the drivers are installed and the device is working properly.

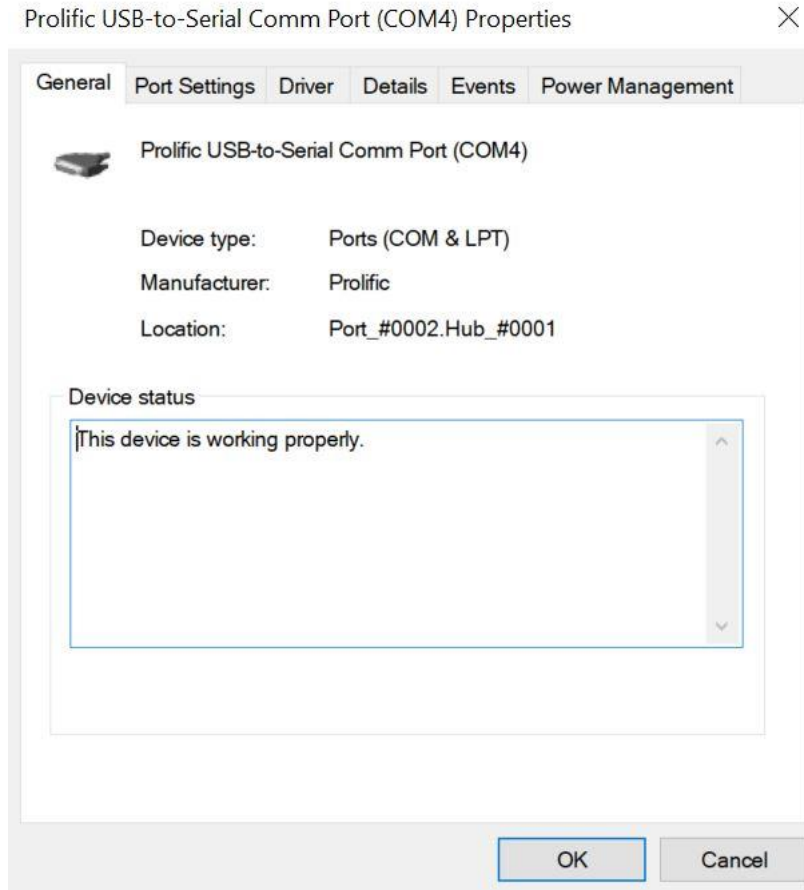

- 3 Select the **Port Settings** tab, then click the **Advanced** button. Do not change the Baud rate or any port settings. This will be done by CME through Windows.

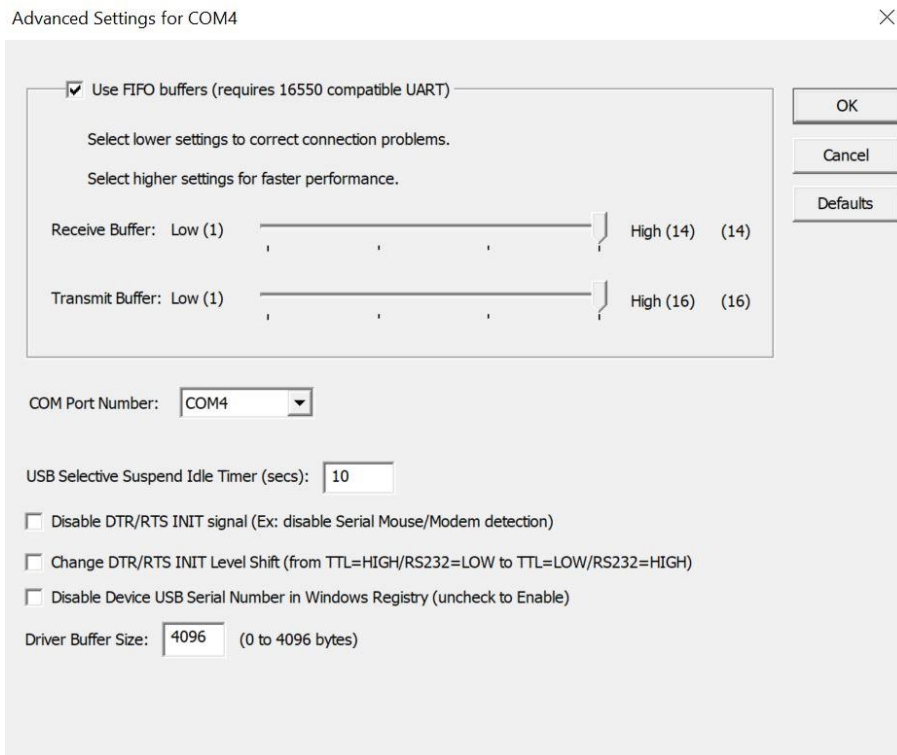
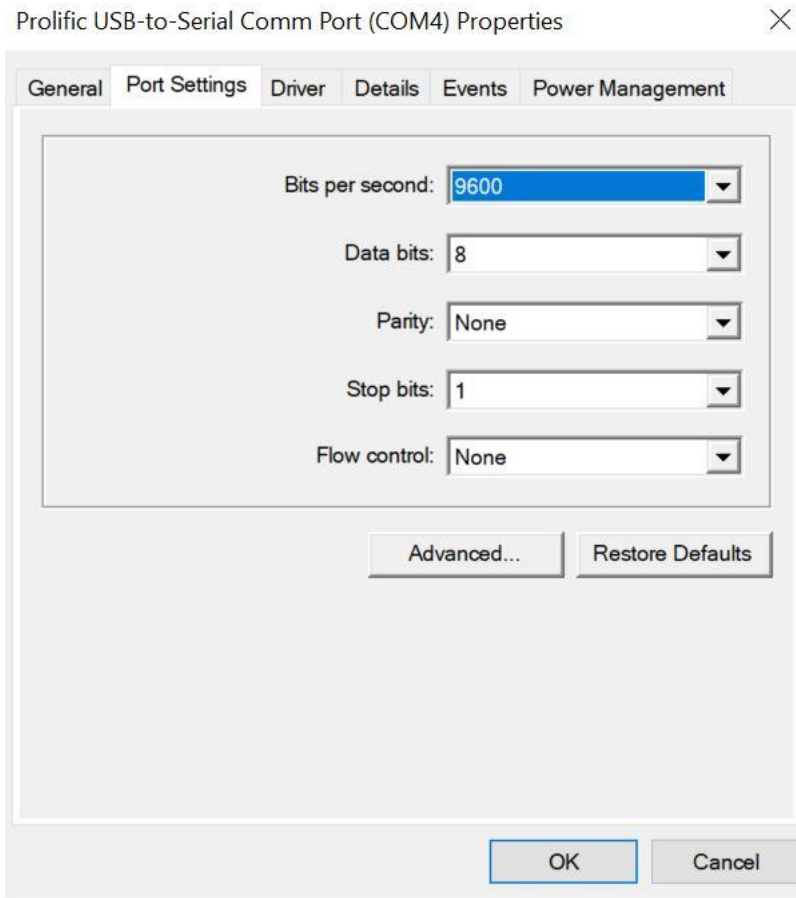

## APPENDIX E

### Faults, Warnings & Status

Bit	Event	Name	Description	Fault Corrective actions
0	Fault	Short Circuit	Output to motor or regen measured is greater than twice peak	Check cable and motor or regen for short output to ground or output to output.
1	Fault	Drive over temp	Amp over temp drive protection.	Increase air flow, add heatsink kit, or reduce duty cycle.
2	Fault	Over voltage	DC bus above drive rating. Output shutdown	Check DC bus for pump up when stopping, add capacitance, or reduce deceleration rate.
3	Fault	Under voltage	DC bus below minimum	Check DC bus for drooping or collapsing, improve power source, or reduce acceleration.
4	Fault	Motor temp sensor	Motor temperature sensor open or closed	Check motor temperature confirm sensor circuit.
5	Fault	Feedback error	Problem with feedback circuits	Check Encoder Status for more details, check voltage levels, Confirm Encoder power regulated.
6	Fault	Phasing error	Problem with commutation or phasing	Check Halls states vs Encoder count. Test encoder for no drift. Do not hot swap. Check manual phasing.
7	Warning	Current limited	Current folds back to protect the drive or motor	Reduce duty cycle, remove friction, Check motor Arms vs drive Ic Apk ratings. (1Arms = 1.414Apk).
8	Warning	Voltage limited	PWM output hits 95% duty cycle	Momentary voltage limit is okay however, if output speed is limited and waning is constant then increase dc bus or slow down.
9	Fault	Pos limit switch	Positive limit switch is active move aborts	If hold position at limit is selected, then motor will servo in position otherwise no current in direction of limit
10	Fault	Neg limit switch	Negative limit switch is active move aborts	If hold position at limit is selected, then motor will servo in position otherwise no current in direction of limit
11	Status	HW Enable inactive	Hardware Enable	Check IN1 for correct levels. Typically, IN1 input (SW input 0) is active low enable and stop settings are configured for controlled stop.
12	Status	SW Enable inactive	Software Enable	Check that master can move drive to op-state. If Copley mode is "Disabled" change to another mode.
13	Warning	Stopping	Trajectory aborted attempting to stop	Normal event when hardware disabled or master commands. Trajectory will abort when fault occurs so check faults for root cause.

14	Status	Brake activated	Brake FET is turned on	Check that brake is holding
15	Fault	PWM disabled	Drive PWM output H-bridge stage is OFF	Check for HW and SW enable or no faults
16	Status	Pos soft limit	Positive Software limit	Soft limits apply after homing. Move will stop using soft limit deceleration rate and hold on soft limit. Check soft limit deceleration rate.
17	Status	Neg soft limit	Negative Software limit	Soft limits apply after homing. Move will stop using soft limit deceleration rate and hold on soft limit. Check soft limit deceleration rate.
18	Fault	Tracking error	Following error limit exceeded	Some limit is preventing move. Check mechanical system and current limits. Reduce duty cycle.
19	Warning	Tracking warning	Following error above warning limit	Danger of following error. Some limit is affecting move. Check mechanical system and current limits. Reduce duty cycle.
20	Status	Resetting	Drive is presently being reset	Wait for reset to complete
21	Status	Position wrap	Position has wrapped	If wrap is set to some value count will start at 0 again at that value. Otherwise, if wrap is not set, the Position variable wraps at full scale range. This type of counting is called position wrapping or modulo count.
22	Fault	Drive Fault	Power-up diagnostic	Rest or power cycle the drive. Make sure power cabling and grounding is correct.
23	Warning	Velocity limit	velocity limited to configured value	Increase the velocity limit to 10% greater than rated or required speed.
24	Warning	Acceleration limit	Acceleration limits command	Velocity mode only. If command exceeds limit the summing junction will only get limit.
25	Warning	Tracking Window.	Following error is in tracking window	If Position Loop Error is outside of Position Tracking Error Limit, then position is not tracking, or move has not settled.
26	Status	Home switch active	Home switch input active	An input configured as home switch will capture position when activated. Normally for purposes of homing.
27	Status	In motion	Moving or not settled	Set if the trajectory generator is running a profile, or the Position Tracking Error Limit is outside the tracking window. Clear when settled into position.
28	Status	Velocity window	Velocity not tracking	Set if the absolute velocity error exceeds the velocity window value.
29	Warning	Phase not initialized	Algorithmic (No Halls) commutation run after enable	After enable algorithmic phasing will wiggle the motor to find phase. Confirm phase initialized and good before commanding move.



CME User Guide

30	Fault	Command Input	Master command signal not present.	Master (CANopen or ECAT) not connected or not sending message in time configured by master. Turn off guard time if CANopen master not connected. If PWM command source check for command or allow 100% command.
31	Fault	Not defined.		

CME User Guide

P/N 16-01157

Revision 02

April 2019

© 2019

Copley Controls

20 Dan Road

Canton, MA 02021 USA

All rights reserved